

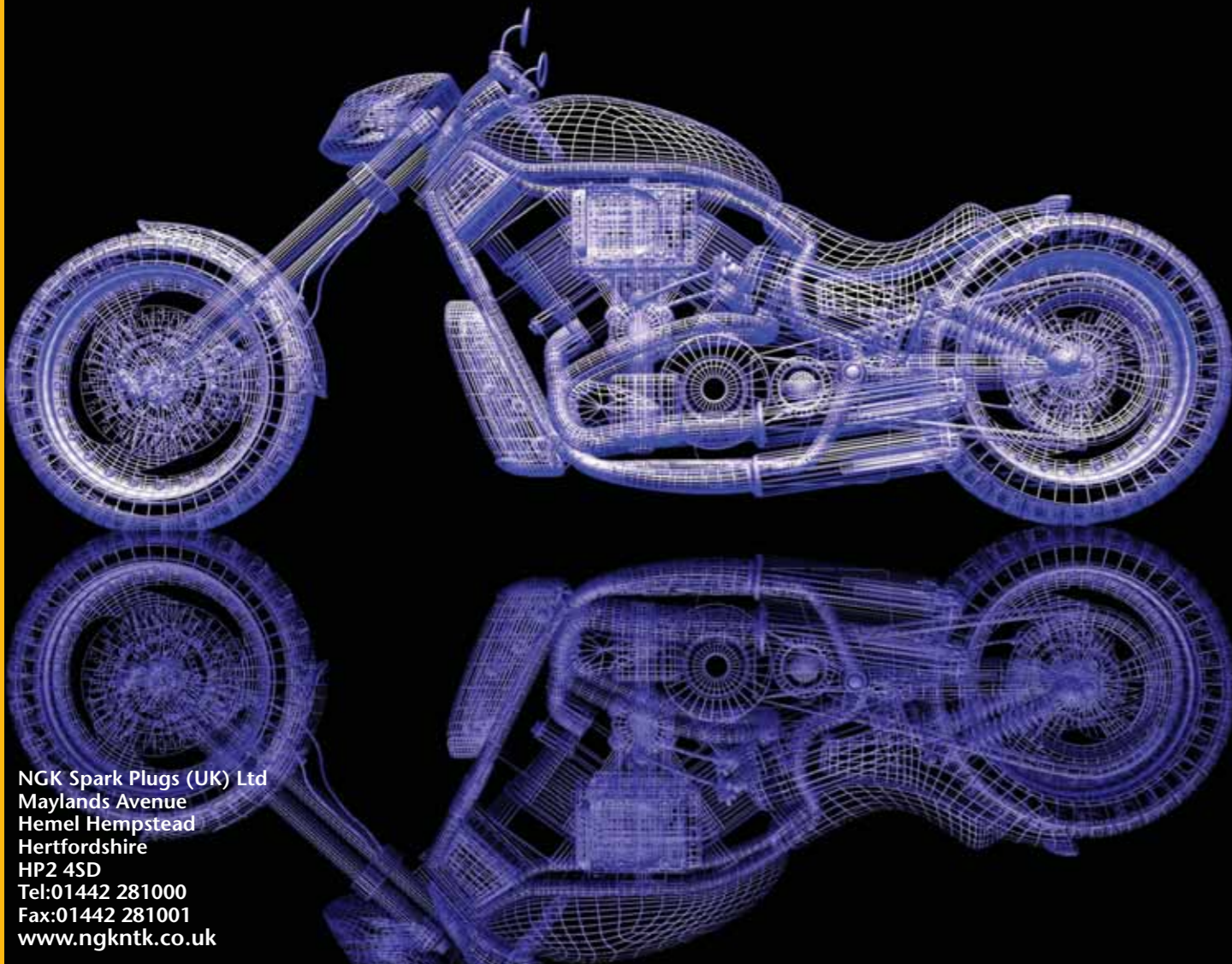

THE WORLD'S No.1 SPARK PLUG



NGK Spark Plugs (UK) Ltd
Maylands Avenue
Hemel Hempstead
Hertfordshire
HP2 4SD
Tel:01442 281000
Fax:01442 281001
www.ngkntk.co.uk



NGK Motorcycle Applications 2014

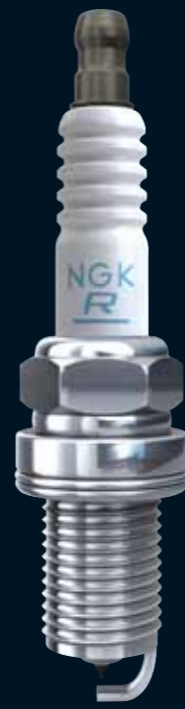

Motorcycle Applications 2014





Now look at what NGK's superior copper core technology delivers.

Bikers won't fit anything else



Around the world bikers and bike manufacturers agree that when it comes to spark plugs, one plug is king. NGK. Which is why they are the world's No.1 OE fitment. So don't try fitting anything else.

You have been warned.

www.ngkntk.co.uk

Original Equipment suppliers to:- Aprilia BMW CCM Cagiva Derbi Ducati Gas Gas Honda Husqvarna Indian Kawasaki KTM Moto Guzzi Norton Peugeot Polaris Royal Enfield Scorpa Suzuki SMC TGB Triumph Victory Yamaha

- Perfect Ignition
- Better cold weather starting
- Better engine performance
- More complete combustion
- Better emissions and cleaner exhaust
- Wider heat range over all driving conditions

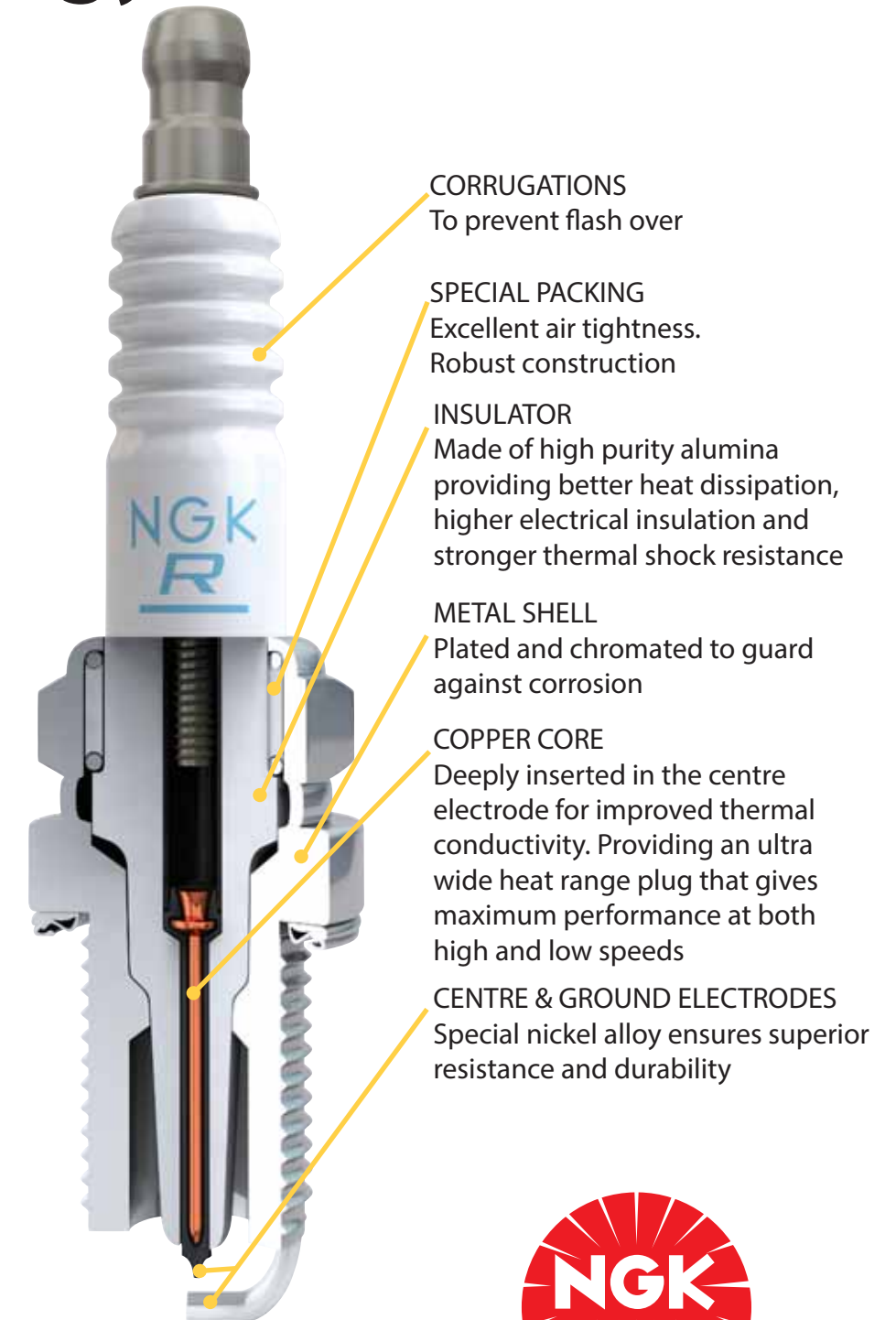

NGK. Pioneers of copper core spark plugs since 1958, and now undisputed leaders in spark plug technology.

www.ngkntk.co.uk



CONTENTS

SPARK PLUG APPLICATIONS

Spark Plug Design _____	2	Spark Plug Installation Tips _____	8
NGK's Copper Core Technology _____	3	Spark Plug Gap Settings _____	8
The Best Spark Plug for every occasion _____	4	Design Symbols _____	9
Fitting the Correct Spark Plug _____	5	New Additions and Part Numbers _____	10
The Iridium IX Spark Plug _____	6-7		

2 Wheel

Adly _____	11	Hyosung _____	32-33	Ossa _____	46	Yamasaki _____	64
AJS _____	11	Indian _____	33	Peugeot _____	46-47	Znen _____	64
Aprilia _____	11-13	Italjet _____	33	PGO _____	47	Zongshen _____	64
Atala _____	13	Jawa-CZ _____	33	Piaggio/Vespa _____	48-49	ATV Quad 	
Bajaj _____	13	Jialing _____	33-34	Pioneer _____	49	Adly _____	65
Baotian _____	13	Jianshe _____	34	Puch _____	49	Apache _____	65
Barossa _____	13	Jinlun _____	34	Pulse _____	49	Arctic Cat _____	65
Bashan _____	13	Jonway _____	34	Regal Raptor _____	49	Blast (LEM) _____	65
Batavus _____	13	Kawasaki _____	34-38	Regent _____	50	Bombardier (→05) _____	65-66
Benelli _____	14	Kenos _____	38	Riders _____	50	Can-Am (BRP) _____	66
Benzhou _____	14	Keeway _____	38	Rieju _____	50	Cectek _____	66
Beta/Betamotor _____	14-15	Kreidler _____	38	Rovigo _____	50	Clubcar _____	66
Bimota _____	16	KTM _____	38-40	Royal Enfield (1980→) _____	50	CPI _____	66
BMW _____	16-17	Kymco _____	40-41	RTX _____	50	Cub Cadet _____	66
BSA _____	17	Lambretta _____	41	Sachs _____	50-51	Dinli _____	66
Buell _____	17	Laverda _____	41-42	Scorpa _____	51	E-Ton _____	67
Cagiva _____	18	LEM _____	42	Sherco _____	51	Gas Gas _____	67
CCM (Armstrong-CCM) _____	18-19	Lexmoto _____	42	Simson _____	51	Honda _____	67
CF Moto _____	19	Lifan _____	42	Sinnis _____	52	Hymoto _____	67
Cossack _____	19	LML _____	42	Skyteam _____	52	Hyosung _____	67
CPI _____	19	Magni _____	42	SMC _____	52	Kawasaki _____	68
Daelim _____	20	Maico _____	42	Superbyke _____	52	Kazuma _____	68
Derbi _____	20	Malaguti _____	43	Suzuki _____	52-55	KTM _____	68
Ducati _____	20-22	MBK _____	43	SWM _____	56	Kubota _____	68
Fantic _____	22	Montesa _____	43	SYM _____	56	Kymco _____	68
Gas Gas _____	23	Moto Guzzi _____	44	TGB _____	56	LEM _____	69
Generic _____	24	Moto Hispania _____	44	Tomos _____	57	Masai _____	69
Gilera _____	24-25	Moto Morini _____	45	Triumph - Pre 1989 _____	57	Massey Ferguson _____	69
Harley Davidson _____	25	Moto Roma _____	45	Triumph - 1991 ON _____	57-58	Moto Roma _____	69
Hero-Puch _____	25	Motobecane _____	45	Uralmoto _____	58	Polaris _____	69
Hesketh _____	25	MS _____	45	Vertemati _____	58	Quadzilla _____	70
Honda _____	25-30	MV Agusta _____	45	Victory (Polaris) _____	58	Quantum _____	70
Huoniao _____	30	MZ _____	46	VOR _____	58	Skyteam _____	70
Husaberg _____	30	Neval _____	46	WK _____	58	Suzuki _____	70
Husqvarna _____	30-32	Nipponia _____	46	Wuyang _____	59	Sym _____	70
Hymoto _____	32	Norton _____	46	Xispa _____	59	TGB _____	71
				Yamaha _____	59-63	Yamaha _____	71-72

SPARK PLUG TECHNICAL INFORMATION

Conversion Chart _____	73-97
Cover Symbols Explanation Chart _____	99
NGK Resistor Plug Covers _____	99
Spark Plug Covers _____	100-101
Plug Cover Supersessions _____	102

LAMBDA SENSORS

NTK Lambda Sensors for Motorcycles _____	103
Technical Information _____	103
Aprilia _____	104
BMW _____	104

Ducati _____	105
Honda _____	105
Husqvarna _____	105
Hyosung _____	105
KTM _____	105
Kymco _____	105
Moto Guzzi _____	106
Moto Morini _____	106
MV Agusta _____	106
Suzuki _____	106
Triumph _____	107
Connector Types _____	108

This catalogue lists only vehicles officially imported or manufactured in the UK and is effective from January 2014 and supersedes all previous catalogues. Whilst every care is taken in compiling these lists of applications, they are given for general guidance only, and they do not constitute any contractual term, representation or warranty and as such NGK do not accept any responsibility in respect of any claim whatsoever and howsoever caused arising from the publication of this catalogue.

NGK and NTK products are designed solely for use in automotive, motorcycle, marine, horticultural, agricultural, commercial, industrial, and all stationary engines.

NGK and NTK products should not be used in aircraft engines.

Resistor spark plugs should always be used where they are recommended by the manufacturer. The use of non-resistor plugs could, in some cases, result in interference with and/or damage to electronic components.

NGK and NTK products listed in the application guides do not apply to racing or modified engines, except where explicitly stated.

SPARK PLUG DESIGN

SPARK PLUG DESIGN

Every year the range of NGK spark plugs grows to accommodate the ever increasing demands of modern engines. Spark plug design must take into consideration many features of an engine including physical dimensions, combustion chamber shape, cooling abilities, fuel and ignition systems. Spark plugs play a vital role in producing the maximum power from an engine whilst keeping fuel consumption and emissions to a minimum. Choosing the correct spark plug type will help a vehicle manufacturer meet legislated emission targets and assists the motorist in getting the best from their engine.

Increases in the size and the requirement to improve the cooling of the inlet and exhaust valves have meant that the space available for the spark plug is severely restricted on some cylinder heads. A change in spark plug design, possibly the adoption of a taper seat and extended reach (threaded portion) or even the use of a smaller diameter is often the answer. Some engines require the use of two spark plugs per cylinder and again due to space restrictions these might be of different sizes.

Changes in fuelling systems and the fuel itself have meant some special features being adopted at the 'firing end' of the spark plug. Extra projected types push the spark position into the heart of the combustion chamber to promote better combustion of the fuel/air mixture, which is weaker than ever in an effort to improve economy. Modern engine manufacturers often require increased spark gaps to allow a longer spark duration, which again aids more efficient combustion.

To combat the 'cold fouling' effect that can occur in some engines using unleaded fuels specially arranged ground electrode arrangements are sometimes used. These can force the spark to discharge across the insulator and thus burn away any built up carbon that could cause poor starting or misfires. It is not uncommon to find two, three or four ground electrode arrangements in new vehicles. The use of precious metals on the tips of the spark plug electrodes is not uncommon especially on higher performance engines. Whilst these spark plugs do have increased service life they are often specified because of their superior ignition qualities.

Our engineering departments work very closely with the engine and vehicle manufacturers to produce the ideal spark plug type for each application. Any change in production is expensive for a manufacturer and therefore new spark plug types are only produced where necessary. NGK employ the very latest production technology to ensure that every aspect is catered for – performance, economy and value.

HEAT RANGE AND HEAT DISSIPATION

Spark plugs do not produce heat in the combustion chamber. One of the functions of the spark plug is to dissipate some of the heat produced during combustion. This is mostly transferred into the cylinder head. The 'Heat Range' indicates the measure of the spark plug's ability to do this. A 'hot' spark plug is designed to maintain a sufficiently high temperature at the insulator nose to burn off carbon and oil deposits. A 'cold' spark plug is designed to allow a faster transfer of heat to the cylinder head thus preventing overheating and premature failure.

The heat range selection is obviously a complex task with many factors to take into account. NGK engineers therefore make specific recommendations for each engine and the use to which it is put.

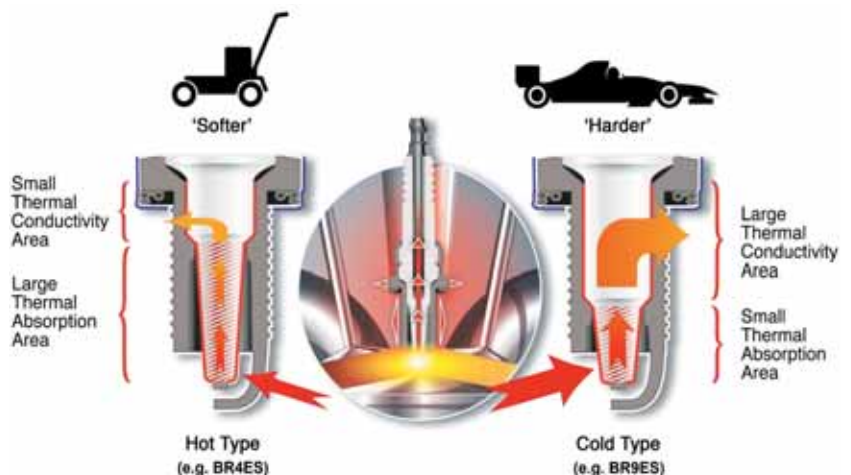

WIDE HEAT RANGE

A wide range spark plug is more flexible and performs equally well in a hot or cold engine under stop and go city driving or fast motorway cruising. Engines that tend to run hot need cold type plugs. Those that run cold demand a hotter type. The specific plug for any engine is determined by the plug's heat range. That is the minimum and maximum temperatures between which the plug will offer optimum performance.

The heat range of NGK Spark Plugs is wider than ordinary plugs therefore they are suitable for both high speed and low speed driving. Compared with conventional plugs of the same pre-ignition rating they have more resistance to fouling. Compared to ordinary plugs with equal anti-fouling resistance, NGK Spark Plugs have a higher pre-ignition rating.

NGK'S HEART OF COPPER

Copper wire used in place of the iron core in conventional plugs is the secret of NGK's Wide Heat Range. Copper's superior heat conductivity dissipates heat quicker. It cools the electrode tip and insulator tip which prevents hot spots that could cause pre-ignition. Increased heat resistance does not affect fouling resistance, which is primarily determined by the insulator nose length. The longer the nose, the more susceptible it is to heat and the more free from fouling. By raising the pre-ignition rating with the high conduction copper and leaving the insulator nose long, NGK produces the Wide Range Plug. One that meets the broad thermal requirements of engines under high and low RPM conditions. All the spark plugs in the Automotive Catalogue have a copper core.



FIRING END APPEARANCE

<p>Firing end temperature °C</p> <p>Overheating area</p> <p>870°</p>		<p>• Overheating The insulator is white and sometimes blistered. If the insulator temperature is over 870°C pre-ignition may occur. Engine power will be reduced and the piston may be damaged.</p>	<p>• Causes</p> <ul style="list-style-type: none"> • Over advanced ignition timing • Too lean a fuel mixture • Blocked injectors • Insufficient cooling • Excessive deposits in the combustion chamber
<p>Optimum temperature area</p> <p>450°</p>		<p>• Good condition The insulator is brown or light grey.</p>	<p>Even if the spark plug is used under good conditions, deposits will accumulate. Regular inspection and replacement is advisable.</p>
<p>Fouling area</p> <p>Idle Temp { 250° 150°</p>		<p>• Fouling Carbon accumulates on the insulator nose forming a leakage path to earth. The engine misfires resulting in bad starting and poor acceleration. Particularly common with unleaded fuel.</p>	<p>• Causes</p> <ul style="list-style-type: none"> • Too rich a fuel mixture • Excessive use of choke • Prolonged slow speed driving or idling • Blocked air filter • Spark plug heat range too cold

THE BEST SPARK PLUG FOR EVERY OCCASION

As a result of our policy of continuous research and development NGK can offer special spark plugs designed to give optimum performance under a high range of conditions.

'S' TYPE (e.g. BP6ES)

NGK standard spark plugs with copper cored centre electrodes for wide heat range. Copper's superior heat conductivity dissipates the heat of combustion away from the firing end, preventing hot spots that can lead to pre-ignition. Copper cored electrodes also mean that longer insulator noses can be used to protect against fouling.

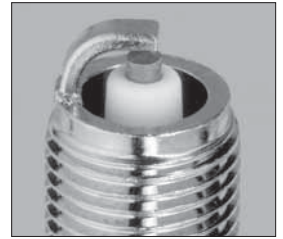

'G' TYPE (e.g. B10EG)

These plugs feature a smaller diameter centre electrode tip made of conventional nickel alloy. The smaller diameter centre electrode means the voltage required to produce a spark is reduced. However as the tip is made of conventional nickel alloy the service life is reduced and these plugs are best used in applications where plugs are frequently changed.



'V' TYPE (e.g. B10EV)

The centre electrode of this type is made of gold palladium alloy and is even smaller in diameter than the G type at 1.0mm and has therefore an even lower voltage requirement. These 'V' types have now been discontinued and replaced with 'VX' or 'IX' equivalents.



'GV' TYPE (e.g. B9EGV)

These plugs have a centre electrode of precious metal similar to the V range. In addition the insulator nose is an improved design to allow better gas flow around the firing end. The ground electrode is shorter and stronger, making the GV range more suited for racing applications.



'VX' TYPE (e.g. B8EVX)

These plugs have an even smaller centre electrode (0.8mm) than the V types and this is made of platinum. This combined with a taper cut ground electrode means an even lower required voltage than the V types. The result is better ignitability along with improved starting, idle stability and anti-fouling performance.



'IX' TYPE (e.g. BR8EIX)

Similar in design to the Platinum VX spark plug, the use of the precious metal Iridium allows us to manufacture a spark plug with an even smaller diameter centre electrode (0.6mm) without compromising durability. This extremely small Iridium tip centre electrode concentrates the available electrical energy and combined with the taper cut ground electrode provides the best performance in terms of starting, idling and especially throttle response.



FITTING THE CORRECT SPARK PLUG

NGK spark plugs are designed using the latest technology to give optimum performance over the engine's entire rev. range. Fitting the correct type of spark plug is essential. Many changes in engine technology has meant changes in spark plug design. Some NGK spark plugs may have a similar appearance, however the internal and or external design can differ sufficiently to cause engine damage should the incorrect part be installed. The examples below display some of the different design features employed in typical motorcycle applications and hopefully help to explain the reason for some application specific part numbers.

CR8EH-9

- Used on some Honda designed engines
- Special thread can only be used in specific engines or the cylinder head will be damaged

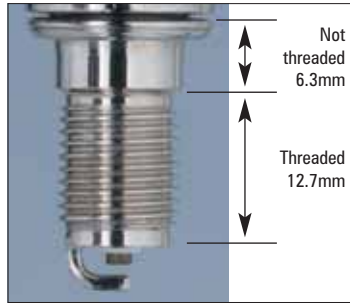

BR10ECM

- Compact style, mainly used by Honda and Suzuki
- For use where space is restricted

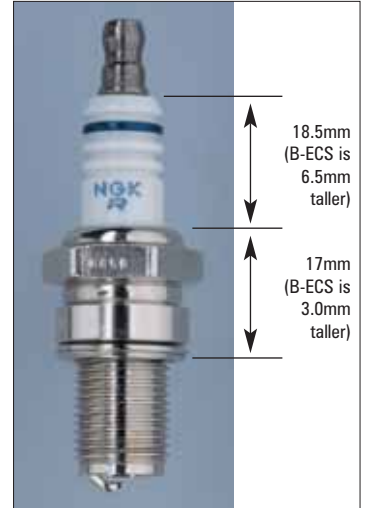

CR6HSA

- Centre electrode is 0.2mm wider than CR6HS for improved durability
- Short metal shell design



CR9EK, JR9C

- Used by Kawasaki and Suzuki
- 2 ground electrodes for improved durability



CR9EK thread diameter \varnothing 10mm



JR9C thread diameter \varnothing 12mm

ER9EH

- Used by Honda, \varnothing 8mm thread with 13mm hex
- Do not exceed the tightening torque of 0.8 - 1.0kg/m

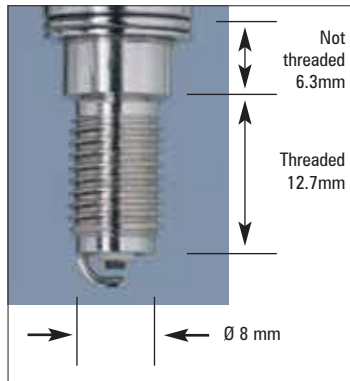

B9ECS

- Short ground electrode for strength and to prevent overheating
- For competition use



THE IRIIDIUM IX SPARK PLUG

The Iridium IX spark plug is similar in design to the Platinum VX type but benefits from the use of the precious metal Iridium on its centre electrode. Iridium is harder than other precious metals used in spark plug manufacture, has an extremely high melting point and offers greater protection from chemical attack. These features allow the use of an extremely **small diameter electrode (0.6mm)** without compromising the spark plug's service life. Combined with the use of the taper cut ground electrode this spark plug has superior gas flow properties and lower voltage requirements, which offers further improvements in starting, idling and throttle response.



BR8EIX

Iridium spark plugs are used by some of the worlds leading race teams and as original equipment in many high performance road and off road machines. Owners who want the very best performance from their bikes will want the best spark plug and this we can offer with Iridium IX.



Iridium IX

A small diameter electrode that gives good gas flow and less restriction of flame kernel

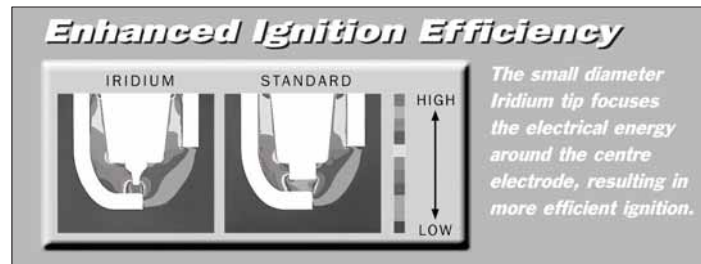

Iridium IX packaging

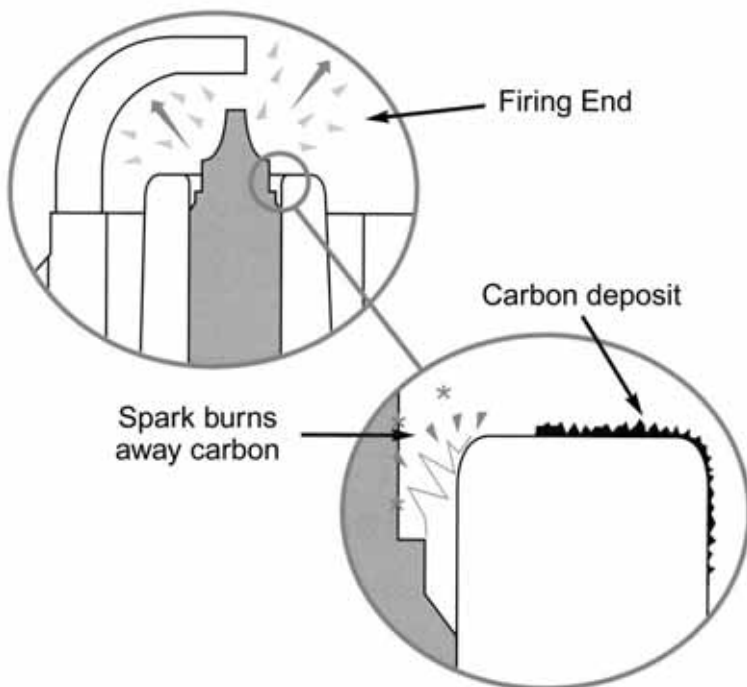

The close up section shows the annular gap between the centre electrode and insulator nose which provides cold fouling protection.

Should current try to leak away across a carbonised insulator a spark can occur between the electrode and the insulator thus burning away the carbon deposit.

THE IRIIDIUM IX SPARK PLUG

The tables below show the Iridium IX upgrade from standard copper core and Platinum VX type. For specific model application refer to the Iridium column in the main data pages.

STANDARD COPPER CORE		PLATINUM VX		IRIDIUM IX	
PART NO.	PART NO.	PART NO.	PART NO.	PART NO.	STOCK NO.
BK6E	BKR6E			BKR6EIX	6418
	BKR6E-11			BKR6EIX-11	3764
	BKR7E			BKR7EIX	2667
BP5ES	BPR5ES			BPR5EIX	6597
BP6ES	BPR6ES			BPR6EIX	6637
	BPR6ES-11			BPR6EIX-11	3903
BP6HS	BPR6HS			BPR6HIX	4085
BP6HS-10	BPR6HS-10				
	BR6HSA				
BP7ES	BPR7ES			BPR7EIX	4055
BP7HS	BPR7HS			BPR7HIX	5944
BP7HS-10	BPR7HS-10				
BP8HS	BPR8HS			BPR8HIX	6742
BP8HS-10	BR8HSA				
B6HS	BR6HS			BR6HIX	3419
B6HS-10	BR6HS-10				
B7ES	BR7ES			BR7EIX	6664
B7HS	BR7HS			BR7HIX	7067
B7HS-10	BR7HS-10				
B8ES	BR8ES			BR8EIX	5044
B8HS	BR8HS			BR8HIX	7001
B8HS-10	BR8HS-10				
B9ES	BR9ES			BR9EIX	3981
	BR10ES			BR10EIX	6801
C6HSA	CR6HSA			CR6HIX	7274
	CR6HS				
	CR7E			CR7EIX	7385

STANDARD COPPER CORE		PLATINUM VX		IRIDIUM IX	
PART NO.	PART NO.	PART NO.	PART NO.	PART NO.	STOCK NO.
C7HSA	CR7HSA			CR7HIX	7544
	CR7HS				
	CR8EH-9			CR8EHIX-9	3797
C8E	CR8E			CR8EIX	4218
	CR8EK				
C8HSA	CR8HSA		CR8HVX	CR8HIX	7669
	CR8HS				
	CR9EH-9			CR9EHIX-9	6216
C9E	CR9E			CR9EIX	3521
	CR10E			CR10EIX	6482
	CR10EK				
	DCPR7E			DCPR7EIX	6046
	DCPR8E			DCPR8EIX	6546
	DCPR8EKC				
	DCPR9E		DCPR9EVX	DCPR9EIX	2316
	DCPR7E#			DCR7EIX	3605
	DCPR8E#			DCR8EIX	3606
	DCPR9E#			DCR9EIX	6650
	DPR7EA-9			DPR7EIX-9	7803
DP8EA-9	DPR8EA-9			DPR8EIX-9	2202
	DPR9EA-9			DPR9EIX-9	5545
D8EA	DR8EA		DR8EVX	DR8EIX	6681
	DR8ES-L				
D9EA	DR9EA		DR9EVX	DR9EIX	4772
	DR8ES*				
	JR9B				

*The upgrade from DR8ES to DR9EIX is correct
For plugs with threaded terminal

As the IX range now takes over the premium motorcycle spark plug position from the popular Platinum VX range we will be superseding some current versions of Platinum VX types as volume production allows. This will be treated as a running change and therefore orders placed for certain resistor VX types will be fulfilled by supplying the Iridium IX equivalent. Most contemporary machines demand the use of resistor types and most older machines can and do use them quite happily.

Below is a chart to show the VX plugs currently affected.

Platinum VX		replaced by	Iridium IX	
Platinum VX	Stock No.		Iridium IX	Stock No.
B7EVX	6934	→	BR7EIX	6664
B7HVX	7836	→	BR7HIX	7067
B8EVX	7051	→	BR8EIX	5044
B8HVX	2634	→	BR8HIX	7001
B9EVX	7254	→	BR9EIX	3981
B10EVX	7335	→	BR10EIX	6801
B10HVX	2940	→	BR10HIX	6692
BKR6EVX	3539	→	BKR6EIX	6418
BKR7EVX	3544	→	BKR7EIX	2667
BP5EVX	5470	→	BPR5EIX	6597
BP7EVX	7270	→	BPR7EIX	4055
BPR5EVX	4875	→	BPR5EIX	6597
BPR6EVX	6764	→	BPR6EIX	6637

Platinum VX		replaced by	Iridium IX	
Platinum VX	Stock No.		Iridium IX	Stock No.
BPR9EVX	5576	→	BPR9EIX	6853
BR8EVX	1262	→	BR8EIX	5044
BR9EVX	1265	→	BR9EIX	3981
CR8EHVX-9	4546	→	CR8EHIX-9	3797
CR8EVX	6487	→	CR8EIX	4218
CR9EHVX-9	3872	→	CR9EHIX-9	6216
CR9EVX	5943	→	CR9EIX	3521
D8EVX	2850	→	DR8EIX	6681
D9EVX	2834	→	DR9EIX	4772
DCPR7EVX	1179	→	DCPR7EIX	6046
DPR7EVX-9	7682	→	DPR7EIX-9	7803
DPR8EVX-9	2872	→	DPR8EIX-9	2202
DPR9EVX-9	3854	→	DPR9EIX-9	5545

SPARK PLUG INSTALLATION TIPS

- Refer to current NGK catalogue for correct spark plug selection
- Check condition and cleanliness of threads in cylinder head
- Ensure plug is gapped according to vehicle manufacturers specification (*fig 1*)
- Multi ground electrode and precious metal plugs should not be regapped - visual inspection only
- Install new spark plug *by hand* until it seats - (*fig 2*) a length of rubber tubing pushed over the insulator can be a useful aid for plug installation where access is difficult
- Tighten to specified torque setting as shown in the chart below (*fig 3*)
- If a torque wrench is unavailable then refer to vehicle/engine manufacturers installation instructions or the tightening angle advice which is displayed on current NGK packaging (excluding specialist race plugs). Note that this angle advice can differ between part numbers due to individual spark plug design (e.g. seating type, thread diameter and gasket material)
- It is important not to over or under tighten spark plugs during installation. Over-tightening can lead to distortion of the spark plug. Under-tightening can cause overheating due to poor heat dissipation. *In extreme cases incorrect tightening can cause spark plug breakage and/or engine damage*
- NGK does not recommend the application of lubricant to spark plug threads as the resultant reduction of frictional forces at the thread faces will render the torque charts inaccurate and over tightening could occur
- If a gasket type spark plug is re-installed, it should only require a further 1/12 of a turn after it has been seated
- Always carefully use the correct tools for removal/installation to prevent damage to the spark plug or engine
- Inspect spark plug cover and renew if necessary

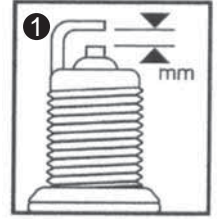

③	FOR FLAT SEAT TYPE (WITH GASKET)					TAPER SEAT TYPE		
	Thread Ø	18mm	14mm	12mm	10mm	8mm	18mm	14mm
Cast iron head	35-45Nm (3.5-4.5kgm) (25.3-32.5lbs ft)	25-35Nm (2.5-3.5kgm) (18.0-25.3lbs ft)	15-25Nm (1.5-2.5kgm) (10.8-18.0lbs ft)	10-15Nm (1.0-1.5kgm) (7.2-10.8lbs ft)	-		20-30Nm (2.0-3.0kgm) (14.5-21.6lbs ft)	15-25Nm (1.5-2.5kgm) (10.8-18.0lbs ft)
Aluminium head	35-40Nm (3.5-4.0kgm) (25.3-28.9lbs ft)	25-30Nm (2.5-3.0kgm) (18.0-21.6lbs ft)	15-20Nm (1.5-2.0kgm) (10.8-14.5lbs ft)	10-12Nm (1.0-1.2kgm) (7.2-8.7lbs ft)	8-10Nm (0.8-1.0kgm) (5.8-7.2lbs ft)		20-30Nm (2.0-3.0kgm) (14.5-21.6lbs ft)	10-20Nm (1.0-2.0kgm) (7.2-14.5lbs ft)

Important: Some spark plugs differ in gasket design or material, refer to tightening advice on specific spark plug packaging

SPARK PLUG GAP SETTINGS

Important: Spark plug gap settings are given in millimetres. Practical equivalents are shown below.

mm	0.4	0.5	0.6	0.7	0.8	0.9	1.0	1.1	1.3	1.4	1.5	1.6	1.8	2.0
ins	.016	.020	.024	.028	.032	.035	.039	.043	.051	.055	.059	.063	.071	.079

DESIGN SYMBOLS

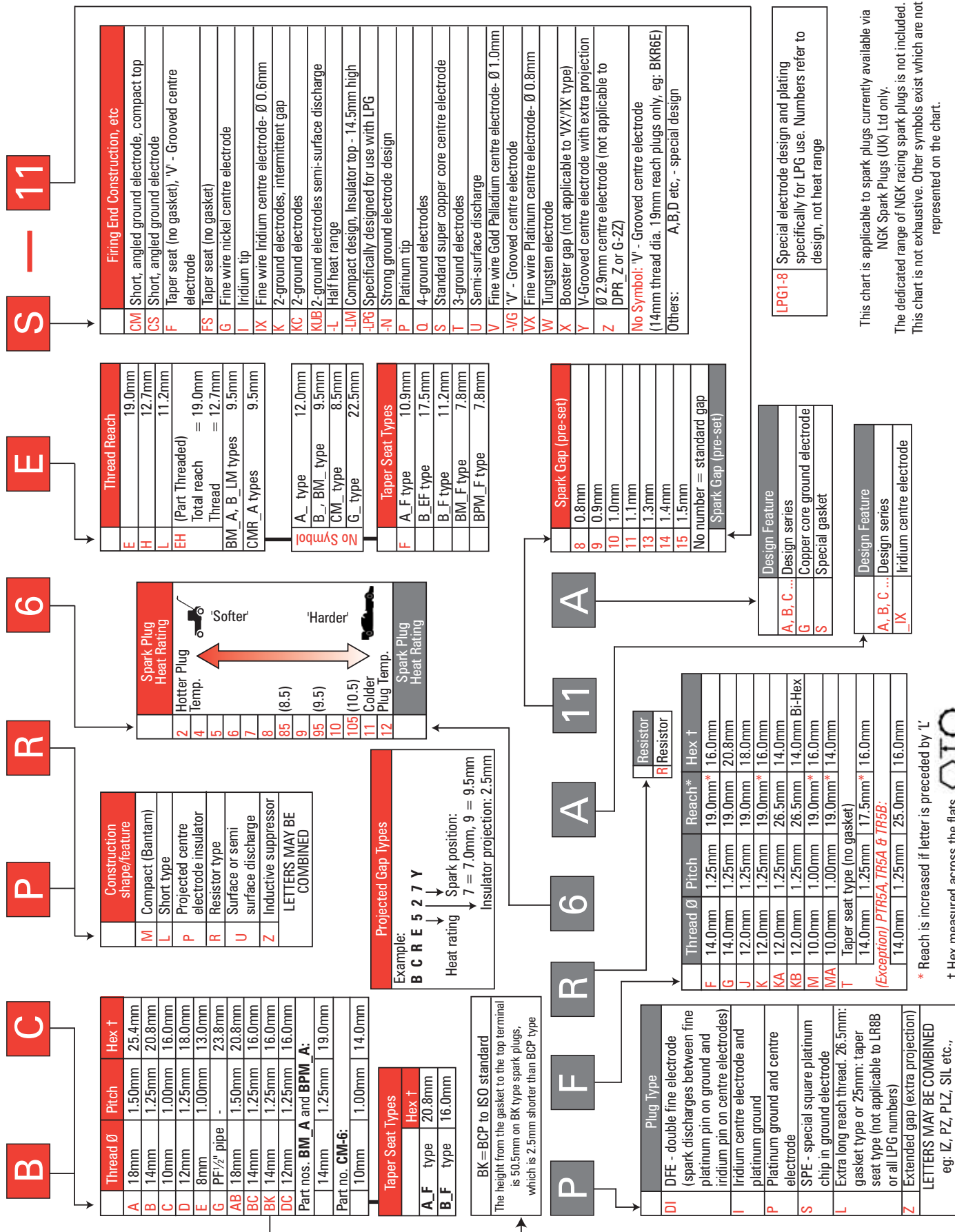

NEW ADDITIONS AND PART NUMBERS

These are new additions to this catalogue that have new part numbers not previously stocked by NGK Spark Plugs (UK) Ltd.

Part Number	Stock Number	Application	Part Number	Stock Number	Application
IMR8C-9HES	5990	HONDA CBF1000A, CBF1000F	LMAR8A-9S	6817	HONDA CB1100

These Spark Plugs will be available during 2013/2014

Listed below is a selection of new applications for existing spark plugs

MAKE	MODEL	PART NO.	STOCK NO.
APACHE (Quads)	RLX F500	DPR7EA-9	5129
APRILIA	Caponord (Twin Spark)	CR8EKB	4374
BENELLI	Cafénero 250	CR8E	1275
BMW	F 700 GS	DCPR8E	4339
	F 800 GT	DCPR8E	4339
	R1200GS (Liquid Cooled)	LMAR8D-J	93444
CAN-AM (Quads)	Maverick	LMAR8C-9	93833
	Outlander MAX	DCPR8E	4179
DAELIM	VJF250 (Roadwin)	CR9EH-9	7502
DERBI	GPR 50	BR8ES	5422
	GPR 125	CR8EB	7784
	Mulhacén Café 125	CR8EB	7784
	Rambla 300i	CR8EKB	4374
DUCATI	Hypermotard	MAR9A-J	6869
	Hyperstrada	MAR9A-J	6869
	Multistrada 1200, S (Incl. Pikes Peak, Sport & Touring) Twin Spark	MAR10A-J	4706
HONDA	CB500F	CPR8EA-9	2306
	CB500X	CPR8EA-9	2306
	CBR500R	CPR8EA-9	2306
	CRF125F	CPR6EA-9	6899
	CRF250M	SIMR8A9	91064
	MSX125	CPR6EA-9	6899
	NSS300 Forza	LMAR8A-9	4313
	NSC50R	CR7HSA-9	5147
SH125i	CPR7EA-9	3901	
HUSABERG	FE250	CR9EKB	2305
HUSQVARNA	SM450RR	CR9EKB	2305
	SM530RR	CR9EKB	2305
	TR650 Strada (Twin Spark)	MAR9A-J	6869
	TR650 Terra (Twin Spark)	MAR9A-J	6869
	TXC250	CR9EB	6955
HYOSUNG	GT650N	CR8E	1275
JONWAY	Madness 50	C7HSA	4629
KAWASAKI	EX300 (Ninja 300)	CR8E	1275
	Z800	CR9EK	4548
	Z800E	CR9EK	4548
	ZX636 (Ninja ZX-6R)	CR9E	6263
KEEWAY	ARN 125	DPR7EA-9	5129
	Hacker 125	DPR7EA-9	5129
	Speed 125	DPR7EA-9	5129
	Superlight 125	DPR7EA-9	5129
KTM	250 SX-F (4-Stroke) Ø10mm Plug (26.5mm Thread Reach)	LMAR9AI-8	97225
	1190 Adventure, R (Twin spark)	LMAR7A-9	4908
	1190 Adventure, R (Twin spark)	LKAR9BI9	6205
KYMCO	Downtown 125i	CR7E	4578
	Downtown 300i	CR7E	4578
	MXU 450i (Quad)	CR7E	4578
	MXU 500i IRS (Quad)	CR7E	4578
	People One 125i	CR7E	4578

MAKE	MODEL	PART NO.	STOCK NO.
LEXMOTO	LSM 50	BR8ES	5422
	Valencia	C7HSA	4629
LIFAN	Beat 125 (LF125-9A)	C7HSA	4629
	Mirage 125 (LF125-J)	D8EA	2120
MOTO GUZZI	V7 Café Racer Ø14mm Plug	BR8ES	5422
	V7 Café Racer Ø10mm Plug	CPR8EB-9	6607
	V7 Special, Stone	CPR8EB-9	6607
MOTO ROMA	SK125	DR8EA	7162
MV AGUSTA	Brutale 675 Trepistone	CR9EKB	2305
	F3 (Incl. Serie Oro)	CR9EKB	2305
NIPPONIA	Dion	CR7HSA	4549
	Miro	CR7HSA	4549
	Neon	BPR7HS	6422
PEUGEOT	Citystar	CR8EB	7784
PIAGGIO / VESPA	Beverly 350 Sport Touring	CR8EKB	4374
	Fly 100 (4-Stroke)	CR8EB	7784
	GTS 125	CR8EB	7784
	GTS 125 Super i.e.	CR8EKB	4374
	MP3 300 (Incl. LT)	CR8EKB	4374
	MP3 400	CR7EKB	4455
	Vespa 946	CR8EB	7784
	Vespa LX 125 3V (4-Stroke)	CR8EB	7784
	Vespa S 125	CR7EB	4663
	Vespa S 50 (2-Stroke)	BR9ES	5722
	X7 125	CR8EB	7784
	X7 125	CR8EKB	4374
	X10	CR7EKB	4455
	Xevo 400	CR7EKB	4455
Zip 50 (4-Stroke)	CR8EB	7784	
PULSE	Force 50 (2-Stroke)	BPR7HS	6422
	Force 50 (4-Stroke)	CR7HS	7223
QUADZILLA (Quads)	RS7	CR6E	6965
	RS8	CR6E	6965
QUANTUM (Quads)	Dingo, Falcon	C7HSA	4629
	NF500L	BKR6E	6962
RIEJU	RS2 125 Pro	CR7HSA	4549
	RS3 NKD 50cc	BR9ES	5722
	RS3 NKD 125cc	CR8E	1275
SKYTEAM (Quads)	LX50ST-C	CR7HSA	4549
	ST200 Quad	DR8EA	7162
TGB (Quads)	Blade 325 SL 2WD	CR8E	1275
	Blade 460 R 2WD	CR7E	4578
	Target 325 SL 2WD	CR8E	1275
TRIUMPH	Daytona 675 (Incl R)	CR9EIA-9	6289
	Thunderbird Storm (Twin Spark)	DPR6EA-9	5531
	Tiger Sport	CR8EK	3478
VICTORY (POLARIS)	Broadwalk	DCPR6E	3481
YAMAHA	FJR1300A/AS	CPR8EA-9	2306
	XT1200Z World Crosser (Twin Spark)	CPR8EB-9	6607
	YFM250R Raptor (Quad)	DR7EA	7839

The above tables are intended as a stock purchase guide. Refer to the relevant model listing in the main application section for product selection.

2 Wheel



CC	MODEL	DATE	STANDARD COPPER CORE	STOCK NUMBER	PLATINUM OR GOLD PALLADIUM	STOCK NUMBER	IRIDIUM	STOCK NUMBER	GAP MM
ADLY									
50	Citybird, Crosser, Fox, Jet X1, Pista, Predator	97→	BPR7HS	6422			BPR7HIX	5944	0.6
100	Cat, Predator, Jet, X1	97→	BPR7HS	6422			BPR7HIX	5944	0.6
125	Activator 125	99→	CR7HSA	4549			CR7HIX	7544	0.5
	AJP 125 PR4	03→	DPR7EA-9	5129			DPR7EIX-9	7803	0.9
	Cat 125	97→	CR7HSA	4549			CR7HIX	7544	0.5

AJS									
50	Chipmunk 50	03→	BP4HS	3611					0.6
	DD50 Regal Raptor	03→	CR7HS	7223			CR7HIX	7544	0.7
	JSM 50 Motard	11→	BR8ES	5422			BR8EIX	5044	0.6
80	Coyote 80	03→	BP6HS	4511			BPR6HIX	4085	0.6
100	Cougar 100 (Jincheng)	03→	BP7HS	5111			BPR7HIX	5944	0.6
	DD100 Regal Raptor	03→	CR7HS	7223			CR7HIX	7544	0.7
125	CR3-125 Super Sports		DR8EA	7162	DR8EVX	6354	DR8EIX	6681	0.6
	JS125Y Tiger	03→	DR8ES	5423	DR9EVX	6361	DR9EIX	4772	0.7
	JSM125 Motard / Trail		CR6HSA	2983			CR6HIX	7274	0.6

APRILIA										
50	AF1 50	88→92	B8ES	2411			BR8EIX	5044	0.5	
	Amico 50	92→94	BR7HS	4122			BR7HIX	7067	0.6	
	Area 51 (Liquid Cooled 2-Stroke)	98→	BR8HS	4322			BR8HIX	7001	0.5	
	Extrema 50	93→	B8ES	2411			BR8EIX	5044	0.5	
	Gulliver	97→99	BR7HS	4122			BR7HIX	7067	0.6	
	Habana 50, Custom & Retro	99→05	BPR8HS	3725			BPR8HIX	6742	0.6	
	Mojito Custom 50	05→	BR9ES	5722			BR9EIX	3981	0.7	
	MX50	03→	BR9ES	5722			BR9EIX	3981	0.7	
	Rally 50 (Air Cooled)	95→99	BR7HS	4122			BR7HIX	7067	0.7	
	Rally 50 (Liquid Cooled)	97→03	BR8HS	4322			BR8HIX	7001	0.5	
	Red Rose 50	93→	B8ES	2411			BR8EIX	5044	0.5	
	RS 50 (Minarelli engine)	93→	B8ES	2411			BR8EIX	5044	0.6	
	RS 50	01→05	BR9ES	5722			BR9EIX	3981	0.7	
	RS 50	06→	BR9ES	5722			BR9EIX	3981	0.5	
	RX 50 (Minarelli engine)	97→	B9ES	2611		B9EVX	7254	BR9EIX	3981	0.6
	Scarabeo 50 Carb	93→	BR7HS	4122			BR7HIX	7067	0.6	
	Scarabeo 50 Di Tech (Injection)	01→	CPR8E	7411			CR8EIX	4218	0.8	
	Scarabeo 50 4T (4-Stroke)	06→	CR9EB	6955			CR9EIX	3521	0.6	
	Sonic FT 50 (Air Cooled 2-Stroke)	98→01	BR8HS	4322			BR8HIX	7001	0.5	
	Sonic GP 50 (Liquid Cooled 2-Stroke)	98→05	BR8HS	4322			BR8HIX	7001	0.5	
	Sportcity One (4-Stroke)	08→	CR8EB	7784			CR8EIX	4218	0.7	
	Sportcity One Street (2-Stroke)	08→	BR9ES	5722			BR9EIX	3981	0.6	
	SR 50 (Air Cooled)	94→	BR7HS	4122			BR7HIX	7067	0.7	
	SR 50 Stealth / LC / Racing (Liquid Cooled)	96→	BR7HS	4122			BR7HIX	7067	0.7	
	SR 50 Carb (19mm Thread Reach)	04→	BR9ES	5722			BR9EIX	3981	0.6	
	SR 50 Di Tech Injection	01→04	CPR8E	7411			CR8EIX	4218	0.8	
	SR 50 Di Tech Injection	05→				ZMR7AP	6914		0.8	
	SR 50 i.e. Pure Jet	04→				ZMR7AP	6914		0.8	
	SR 50 WWW	01→02	BR7HS	4122			BR7HIX	7067	0.6	
	SR 50R	05→	BR9ES	5722			BR9EIX	3981	0.6	
	SR Motard 50 (2-Stroke)	12→	BR9ES	5722			BR9EIX	3981	0.5	
	SX 50	06→	BR9ES	5722			BR9EIX	3981	0.6	
100	Scarabeo 100	00→	BR8HS	4322			BR8HIX	7001	0.6	
125	AF1 125	88→	BR10EG	3830			BR10EIX	6801	0.5	
	AF1 Futura	90→93	BR10EG	3830			BR10EIX	6801	0.5	
	Atlantic 125	03→	CR8EB	7784			CR8EIX	4218	0.8	
	Classic 125	99→	BR10EG	3830			BR10EIX	6801	0.6	
	ETX 125 (Liquid Cooled 2-Stroke)	98→01	BR8ES	5422			BR8EIX	5044	0.5	
	Europa 125	90→	BR10EG	3830			BR10EIX	6801	0.5	
	Habana 125 Custom & Retro (4-Stroke)	99→	CR8E	1275			CR8EIX	4218	0.6	
	Leonardo 125	95→	CR8E	1275			CR8EIX	4218	0.6	
	Leonardo 125 ST	04→					CR8EIX	4218	0.6	
	Mojito Custom 125	05→	CR7EB	4663			CR7EIX	7385	0.6	
	MX125	04→	BR8ES	5422			BR8EIX	5044	0.6	



CC	MODEL	DATE	STANDARD COPPER CORE	STOCK NUMBER	PLATINUM OR GOLD PALLADIUM	STOCK NUMBER	IRIDIUM	STOCK NUMBER	GAP MM
APRILIA (CONTINUED)									
125	Pegaso 125	92→96	BR10EG	3830			BR10EIX	6801	0.5
	Rally 125	89→90	B10EG	3630	B10EGV	5927	BR10EIX	6801	0.5
	Red Rose 125	88→94	BR10EG	3830			BR10EIX	6801	0.5
	RS 125 (12BHP Restricted)	93→	BR8ES	5422			BR8EIX	5044	0.5
	RS 125 (35BHP Unrestricted)	93→	BR10EG	3830			BR10EIX	6801	0.5
	RS 125R Extrema (12BHP Restricted)	93→	BR8ES	5422			BR8EIX	5044	0.5
	RS 125R Extrema (35BHP Unrestricted)	93→	BR10EG	3830			BR10EIX	6801	0.5
	RS125 Tuono	03→	BR8ES	5422			BR8EIX	5044	0.6
	RS4 125	11→	CR9EB	6955			CR9EIX	3521	0.5
	RX125	94→96	BR10EG	3830			BR10EIX	6801	0.5
	RX125 (15BHP Restricted)	08→	BR8ES	5422			BR8EIX	5044	0.7
	RX125 (22BHP Unrestricted)	08→	BR10EG	3830			BR10EIX	6801	0.7
	Scarabeo 125cc (4-Stroke)	99→	CR8E	1275			CR8EIX	4218	0.6
	Sport City 125	04→08	CR8E	1275			CR8EIX	4218	0.6
	Sportcity Cube 125	08→	CR7EB	4663			CR7EIX	7385	0.7
	Sportcity One 125	08→	CR7EB	4663			CR7EIX	7385	0.7
	Sport Pro 125		BR10EG	3830			BR10EIX	6801	0.5
	SR 125	04/99→	BR8ES	5422			BR8EIX	5044	0.5
	SR 125AC	00→	BR8ES	5422			BR8EIX	5044	0.5
	SR MAX 125	11→	CR8EKB	4374			CR8EIX	4218	0.7
SR Motard 125	12→	CR7EB	4663			CR7EIX	7385	0.7	
SX125 (15BHP Restricted)	08→	BR8ES	5422			BR8EIX	5044	0.7	
SX125 (22BHP Unrestricted)	08→	BR10EG	3830			BR10EIX	6801	0.7	
Tuareg Wind 125	89→91	B10EG	3630	B10EGV	5927	BR10EIX	6801	0.5	
150	Leonardo 150	98→01	CR8E	1275			CR8EIX	4218	0.6
	Leonardo 150 ST	02→					CR8EIX	4218	0.6
	Scarabeo 150 (4-Stroke)	99→	CR8E	1275			CR8EIX	4218	0.6
200	Atlantic 200	03→	CR8EB	7784			CR8EIX	4218	0.8
	Scarabeo 200 (4-Stroke)	00→	CR8E	1275			CR8EIX	4218	0.6
	Sportcity 200	04→08	CR7EB	4663			CR7EIX	7385	0.6
	Sportcity Cube 200	08→	CR7EB	4663			CR7EIX	7385	0.7
250	Atlantic 250	04→	CR8EB	7784			CR8EIX	4218	0.7
	Leonardo 250	99→03	DR8EA	7162	DR8EVX	6354	DR8EIX	6681	0.6
	RS 250	94→	BR9ECM	3252	BR9ECMVX	2434			0.7
	Scarabeo 250	04→06	CR8EB	7784			CR8EIX	4218	0.7
	Scarabeo 250	07→09			PMR8B	6378			0.7
	Sport City 250	04→	CR8EB	7784			CR8EIX	4218	0.7
280	Climber trials bike	89→			BP6EVX	5832	BPR6EIX	6637	0.6
300	Leonardo 300	04→	DR8EA	7162	DR8EVX	6354	DR8EIX	6681	0.6
	Sportcity Cube	08→	CR8EKB	4374			CR8EIX	4218	0.7
	SR MAX 300	11→	CR8EKB	4374			CR8EIX	4218	0.7
400	Atlantic 400 Sprint	06→	CR7EKB	4455			CR7EIX	7385	0.8
450	MXV 450	09→	CR8EKB	4374			CR8EIX	4218	0.7
	RXV 4.5	06→08	CR8EB	7784			CR8EIX	4218	0.7
	RXV 4.5	09→	CR8EKB	4374			CR8EIX	4218	0.7
	SXV 4.5	06→08	CR8EB	7784			CR8EIX	4218	0.7
	SXV 4.5	09→	CR8EKB	4374			CR8EIX	4218	0.7
500	Atlantic 500	01→	CR7EKB	4455			CR7EIX	7385	0.8
	Atlantic 500 Sprint	05→	CR7EKB	4455			CR7EIX	7385	0.8
	Scarabeo 500	03→	CR7EKB	4455			CR7EIX	7385	0.8
550	RXV 5.5	06→08	CR8EB	7784			CR8EIX	4218	0.7
	RXV 5.5	09→	CR8EKB	4374			CR8EIX	4218	0.7
	SXV 5.5	06→08	CR8EB	7784			CR8EIX	4218	0.7
	SXV 5.5	09→	CR8EKB	4374			CR8EIX	4218	0.7
600	Pegaso 600	92→	D8EA	2120	DR8EVX	6354	DR8EIX	6681	0.6
	Tuareg 600	88→	D8EA	2120	DR8EVX	6354	DR8EIX	6681	0.6
650	Moto 6.5 (650)	95→	D8EA	2120	DR8EVX	6354	DR8EIX	6681	0.7
	Pegaso 650 (Carburettor)	93→00	D8EA	2120	DR8EVX	6354	DR8EIX	6681	0.6
	Pegaso 650 (Injection) Ø12mm Plug	01→04	DR8EB	4855	DR8EVX	6354	DR8EIX	6681	0.7
	Pegaso Strada & Trail 650 Ø10mm Plug	05→	CR7E	4578			CR7EIX	7385	0.7
	Pegaso Factory	02/07→	CR7E	4578			CR7EIX	7385	0.7
750	Shiver GT (Half faired) (Incl. ABS)	09→	CR7EKB	4455			CR7EIX	7385	0.8
	SL 750 Shiver (Incl. ABS)	07→	CR7EKB	4455			CR7EIX	7385	0.8
	SMV 750 Dorsoduro / Factory	07→	CR7EKB	4455			CR7EIX	7385	0.8



CC	MODEL	DATE	STANDARD COPPER CORE	STOCK NUMBER	PLATINUM OR GOLD PALLADIUM	STOCK NUMBER	IRIDIUM	STOCK NUMBER	GAP MM
APRILIA (CONTINUED)									
839	Mana GT ABS (Twin Spark)	09→	CR7EKB	4455			CR7EIX	7385	0.8
	NA 850 Mana (Incl. ABS) (Twin Spark)	08→	CR7EKB	4455			CR7EIX	7385	0.8
	SRV850 (Twin Spark)	12→	CR7EKB	4455			CR7EIX	7385	0.8
1000	ETV 1000 Caponord	01→	DCPR9E	2641	DCPR9EVX	6436	DCPR9EIX	2316	0.6
	RST 1000 Futura	01→	DCPR9E	2641	DCPR9EVX	6436	DCPR9EIX	2316	0.6
	RSV 1000 R Factory	04→	DCPR9E	2641	DCPR9EVX	6436	DCPR9EIX	2316	0.6
	RSV 4 Factory	09→	CR9EB	6955			CR9EIX	3521	0.7
	RSV 4 R	09→	CR9EB	6955			CR9EIX	3521	0.7
	RSV Mille	98→	DCPR9E	2641	DCPR9EVX	6436	DCPR9EIX	2316	0.6
	RSV Mille R	98→03	DCPR9E	2641	DCPR9EVX	6436	DCPR9EIX	2316	0.6
	RSV Mille R	04→	DCPR9E	2641	DCPR9EVX	6436	DCPR9EIX	2316	0.6
	RSV Mille SP (Sport Production)	00→03	R0045J-10	7400					1.1
	RSV Mille Tuono	02→	DCPR9E	2641	DCPR9EVX	6436	DCPR9EIX	2316	0.6
	SL 1000 Falco	99→	DCPR9E	2641	DCPR9EVX	6436	DCPR9EIX	2316	0.6
	Tuono 1000	04→	DCPR9E	2641	DCPR9EVX	6436	DCPR9EIX	2316	0.6
	Tuono 1000 R	05→	DCPR9E	2641	DCPR9EVX	6436	DCPR9EIX	2316	0.6
Tuono V4R	05/11→	CR9EKB	2305			CR9EIX	3521	0.8	
1197	1200 Dorsoduro	11→	CR8EKB	4374			CR8EIX	4218	0.7
	Caponord (Twin Spark)	13→	CR8EKB	4374			CR8EIX	4218	0.7

ATALA									
50	Byte	97→98	B7HS	5110			BR7HIX	7067	0.5
	Carosello		B7HS	5110			BR7HIX	7067	0.5
	Hacker AT 12, Hacker Racing	97→98	BPR6HS	7022			BPR6HIX	4085	0.6
	Master	98→99	B6HS	4510			BR6HIX	3419	0.6
	Skeggia	99→00	BPR6HS	7022			BPR6HIX	4085	0.6

BAJAJ									
50	Sunny, Bonnie 50	93→	B6HS	4510			BR6HIX	3419	0.5
100	KB100	93→	B8ES	2411			BR8EIX	5044	0.5
125	Vespa, Chetak (Scooter)	93→	B6HS	4510			BR6HIX	3419	0.5
150	Chetak 150	01→	BPR5HS	6222					0.7

BAOTIAN									
50	BT49QT-9 / -11 / -12 Ø10mm Plug	04→	CR7HSA	4549			CR7HIX	7544	0.6
110	BT110-2	04→	CR7HSA	4549			CR7HIX	7544	0.6
125	Citibike 125	04→	CR7HSA	4549			CR7HIX	7544	0.6
	Monza 125		CR7HSA	4549			CR7HIX	7544	0.6
	Tanco 125	04→	CR7HSA	4549			CR7HIX	7544	0.6

BAROSSA									
125	XS125T-13	12/07→	CR7HSA	4549			CR7HIX	7544	0.6

BASHAN									
110	BS110 GY	01→	C7HSA	4629			CR7HIX	7544	0.6
125	BS125 GY	01→	D8EA	2120	DR8EVX	6354	DR8EIX	6681	0.6
200	BS200 GY	01→	D8EA	2120	DR8EVX	6354	DR8EIX	6681	0.6
250	Vixen VX250	06→	DR8EA	7162	DR8EVX	6354	DR8EIX	6681	0.7

BATAVUS									
50	Mondial	80→	B6HS	4510			BR6HIX	3419	0.4
	Stargoi		B7HS	5110			BR7HIX	7067	0.5



CC	MODEL	DATE	STANDARD COPPER CORE	STOCK NUMBER	PLATINUM OR GOLD PALLADIUM	STOCK NUMBER	IRIDIUM	STOCK NUMBER	GAP MM
BENELLI									
50	3G2		B6ES	7310					0.5
	491 Sport, ST GP, Rage, RR SBK, RR GP	98→	BR8HS	4322			BR8HIX	7001	0.5
	49X Quattro Nove	08→	BR8HSA	5539			BR8HIX	7001	0.8
	49X Road	08→	BR8HSA	5539			BR8HIX	7001	0.8
	49X Trek	08→	BR8HSA	5539			BR8HIX	7001	0.8
	50 Cross		B6ES	7310					0.5
	G2 Elle		B6ES	7310					0.5
	K2, K2 Air	98→	BR8HS	4322			BR8HIX	7001	0.5
	Motorella		B6ES	7310					0.5
	Namur 50		BR8HS	4322			BR8HIX	7001	0.5
	Pepe	00→	BR8HS	4322			BR8HIX	7001	0.5
	100	K2 100	99→	BR8HS	4322			BR8HIX	7001
125	125 Roadster/Cross		B7ES	1111			BR7EIX	6664	0.5
	Adiva	00→	CR8EB	7784			CR8EIX	4218	0.8
	Velvet 125	99→	CR8E	1275			CR8EIX	4218	0.6
150	Adiva 150	00→	CR8E	1275			CR8EIX	4218	0.6
230	254 & 304	80→	B7HS	5110			BR7HIX	7067	0.5
250	250 (4-cyl.)		C7HSA	4629			CR7HIX	7544	0.5
	250 Super		B8ES	2411			BR8EIX	5044	0.5
	Adiva		CR8EB	7784			CR8EIX	4218	0.8
	Cafénero 250	12→	CR8E	1275			CR8EIX	4218	0.6
	Velvet 250	00→	CR8E	1275			CR8EIX	4218	0.6
350	354 Sei	80→	D8EA	2120	DR8EVX	6354	DR8EIX	6681	0.5
400	Velvet 400	03→04	CR9E	6263			CR9EIX	3521	0.7
500	Quattro 500	73→83	D8EA	2120	DR8EVX	6354	DR8EIX	6681	0.5
650	654 Sei	80→	D8EA	2120	DR8EVX	6354	DR8EIX	6681	0.5
750	750 Sei		D8EA	2120	DR8EVX	6354	DR8EIX	6681	0.5
900	900 Sei	79→	D8EA	2120	DR8EVX	6354	DR8EIX	6681	0.5
	TNT 899/S/T (Tornado Naked Tre)	08→	CR9E	6263			CR9EIX	3521	0.7
	Tornado Tre 900/903 RS	02→	CR9E	6263			CR9EIX	3521	0.7
	Tornado Tre 903	08→	CR9E	6263			CR9EIX	3521	0.7
	Tre-K 899	09→	CR9EB	6955			CR9EIX	3521	0.7
1130	TNT R160	10→	CR9EB	6955			CR9EIX	3521	0.7
	TNT 1130, K	04→	CR9E	6263			CR9EIX	3521	0.7
	TNT 1130 Titanium	06→	CR9E	6263			CR9EIX	3521	0.8
	TNT 1130 Sport Evo (Tornado Naked Tre)	07→	CR9E	6263			CR9EIX	3521	0.8
	TNT Café Racer 1130	01/06→	CR9E	6263			CR9EIX	3521	0.8
	Tornado Tre 1130	06→	CR9E	6263			CR9EIX	3521	0.7
	Tornado Tre K	06→	CR9E	6263			CR9EIX	3521	0.7
	Tre-K 1130K (Incl. Amazonas)	07→	CR9EB	6955			CR9EIX	3521	0.7

BENZHOU									
50	YY50QT		CR7HSA	4549			CR7HIX	7544	0.6
125	YY125T		CR7HSA	4549			CR7HIX	7544	0.6
150	YY150		CR7HSA	4549			CR7HIX	7544	0.6
250	YY250		DR8EA	7162	DR8EVX	6354	DR8EIX	6681	0.6

BETA / BETAMOTOR									
50	Ark (Air Cooled)	98→	BR7HS	4122			BR7HIX	7067	0.6
	Ark (Liquid Cooled)	97→	BR8HS	4322			BR8HIX	7001	0.7
	Eikon 50	99→	BR8HS	4322			BR8HIX	7001	0.7
	Enduro 50		BR10ES	4832			BR10EIX	6801	0.7
	Mini Cross 10/10, 12/13, 12/15 & Mini Trial		B7HS	5110			BR7HIX	7067	0.6
	Quadra	97→	BR7HS	4122			BR7HIX	7067	0.6
	R10		B7HS	5110			BR7HIX	7067	0.6
	R12		B7HS	5110			BR7HIX	7067	0.6
	Rev 50	03→	B9ES	2611	B9EVX	7254	BR9EIX	3981	0.5
	RR Enduro 50	98→	BR10ES	4832			BR10EIX	6801	0.7
	RR Enduro 50, Racing 50 (Euro 2)	04→	BR9ES	5722			BR9EIX	3981	0.6
	RR 50 Motard	08→	BR9ES	5722			BR9EIX	3981	0.6
	Supermotard 50		BR10ES	4832			BR10EIX	6801	0.7
	Supermoto 50		BR10ES	4832			BR10EIX	6801	0.7



CC	MODEL	DATE	STANDARD COPPER CORE	STOCK NUMBER	PLATINUM OR GOLD PALLADIUM	STOCK NUMBER	IRIDIUM	STOCK NUMBER	GAP MM
BETA / BETAMOTOR (CONTINUED)									
50	Tempo		BR7HS	4122			BR7HIX	7067	0.6
	Zero		B8ES	2411			BR8EIX	5044	0.5
70	Supersmoto 72, Enduro 72				B10HVX	2940	BR10HIX	6692	0.6
80	EVO 80, Junior	09→	BR8ES	5422			BR8EIX	5044	0.6
	Rev 80	03→	B9ES	2611	B9EVX	7254	BR9EIX	3981	0.5
107	R107-4T		C7HSA	4629			CR7HIX	7544	0.7
125	125 E6G		B7HS	5110			BR7HIX	7067	0.5
	125 Enduro		B7HS	5110			BR7HIX	7067	0.5
	125 Trial		B6ES	7310					0.5
	Alp 4T 125	00→	DR8EA	7162	DR8EVX	6354	DR8EIX	6681	0.6
	Eikon 125	99→	DPR7EA-9	5129			DPR7EIX-9	7803	0.9
	Euro 125		DR8EA	7162	DR8EVX	6354	DR8EIX	6681	0.6
	EVO 125 2T	09→	BR7ES	5122			BR7EIX	6664	0.6
	Minicross R 125 4T		C7HSA	4629			CR7HIX	7544	0.7
	RE 125 4T		CR7HSA	4549			CR7HIX	7544	0.6
	REV 3 125 Trials	00→07	BP7ES	2412	BP7EVX	7270	BPR7EIX	4055	0.6
	REV 3 125 Trials	08→	BR7ES	5122			BR7EIX	6664	0.7
	RR 125 4T Enduro, Motard		CR7HSA	4549			CR7HIX	7544	0.6
	Synt		B8ES	2411			BR8EIX	5044	0.5
	TR32		B8ES	2411			BR8EIX	5044	0.5
	TR34		B8ES	2411			BR8EIX	5044	0.5
	TR35		B8ES	2411			BR8EIX	5044	0.5
	Urban 125	08→	CR7HSA	4549			CR7HIX	7544	0.6
Zero		B8ES	2411			BR8EIX	5044	0.5	
150	Eikon 150	99→	DPR7EA-9	5129			DPR7EIX-9	7803	0.9
200	Alp 4T 200	00→	DR8EA	7162	DR8EVX	6354	DR8EIX	6681	0.6
	EVO 200 2T	09→	BR7ES	5122			BR7EIX	6664	0.6
	REV 3 200 Trials	00→07	BP7ES	2412	BP7EVX	7270	BPR7EIX	4055	0.6
	REV 3 200 Trials	08→	BR7ES	5122			BR7EIX	6664	0.7
	Techno 200 Trial	→96	BR8ES	5422			BR8EIX	5044	0.6
	Techno 200 Trial	96→	BP7ES	2412	BP7EVX	7270	BPR7EIX	4055	0.6
	Urban 200	08→	DR8EA	7162	DR8EVX	6354	DR8EIX	6681	0.6
240	Super Trial		B8ES	2411			BR8EIX	5044	0.5
	TR33		B6ES	7310					0.5
	Trial		B6ES	7310					0.5
250	Enduro		B7HS	5110			BR7HIX	7067	0.5
	EVO 250 2T	09→	BR7ES	5122			BR7EIX	6664	0.6
	EVO 250 4T	09→	CR7EB	4663			CR7EIX	7385	0.6
	REV 3 250 2T Trials	00→07	BP7ES	2412	BP7EVX	7270	BPR7EIX	4055	0.6
	REV 3 250 2T Trials	08→	BR7ES	5122			BR7EIX	6664	0.7
	REV 4T 250 Trials	07→	CR7EB	4663			CR7EIX	7385	0.6
	RR 250 4T		DCPR8E*	4339			DCR8EIX	3606	0.7
	Techno 250 Trial	→96	BR8ES	5422			BR8EIX	5044	0.6
	Techno 250 Trial	96→	BP7ES	2412	BP7EVX	7270	BPR7EIX	4055	0.6
TR32		B8ES	2411			BR8EIX	5044	0.5	
260	Synt		B8ES	2411			BR8EIX	5044	0.5
	TR34		B8ES	2411			BR8EIX	5044	0.5
	TR35		B8ES	2411			BR8EIX	5044	0.5
	Zero Gara		B8ES	2411			BR8EIX	5044	0.5
270	REV 3 270 Trials	00→07	BP7ES	2412	BP7EVX	7270	BPR7EIX	4055	0.6
	REV 3 270 Trials	08→	BR7ES	5122			BR7EIX	6664	0.7
	Techno 270 Trial	→96	BR8ES	5422			BR8EIX	5044	0.6
	Techno 270 Trial	96→	BP7ES	2412	BP7EVX	7270	BPR7EIX	4055	0.6
290	EVO 290 2T	09→	BR7ES	5122			BR7EIX	6664	0.6
300	EVO 300 4T	09→	CR7EB	4663			CR7EIX	7385	0.6
350	Alp 4.0 (Suzuki engine)		CR9EK	4548			CR9EIX	3521	0.7
	Euro 350	01→	CR9EK	4548			CR9EIX	3521	0.7
	Jonathan 350		CR9EK	4548			CR9EIX	3521	0.7
	M4 4T		CR9EK	4548			CR9EIX	3521	0.7
	Motard 4.0		CR9EK	4548			CR9EIX	3521	0.7
400	RR 400 4T		DCPR8E*	4339			DCR8EIX	3606	0.7
450	RR 450 4T		DCPR8E*	4339			DCR8EIX	3606	0.7
525	RR 525 4T		DCPR8E*	4339			DCR8EIX	3606	0.7



* Please note DCPR8E 4339 has a removable terminal nut, whereas DCPR8E 4179 has a fixed terminal nut





CC	MODEL	DATE	STANDARD COPPER CORE	STOCK NUMBER	PLATINUM OR GOLD PALLADIUM	STOCK NUMBER	IRIDIUM	STOCK NUMBER	GAP MM
BIMOTA									
500	500 V-Due		BR9ES	5722			BR9EIX	3981	0.7
600	YB9 SRi		CR9E	6263			CR9EIX	3521	0.7
900	DB3 Mantra		DPR8EA-9	4929			DPR8EIX-9	2202	0.6
	DB4		DPR8EA-9	4929			DPR8EIX-9	2202	0.6
	Mantra		DPR7EA-9	5129			DPR7EIX-9	7803	0.9
992	DB5	05→	DCPR8E*	4339			DCR8EIX	3606	0.9
	DB6 Delirio	06→	DCPR8E*	4339			DCR8EIX	3606	0.9
1000	Mono, Biposto	91→93	D8EA	2120	DR8EVX	6354	DR8EIX	6681	0.6
	SB8R/S	99→00	CR9EK	4548			CR9EIX	3521	0.7
	YB11 Superleggera	00→	DR8EA	7162	DR8EVX	6354	DR8EIX	6681	0.7
1078	DB5R/S	07→	DCPR8E*	4339			DCR8EIX	3606	0.9
	DB6R/S	08→	DCPR8E*	4339			DCR8EIX	3606	0.9
1098	DB7	09→	MAR10A-J	4706					0.8
1100	SB6, SB6R	97→	CR9E	6263			CR9EIX	3521	0.7

BMW									
125	C1	00→04	CR8EB	7784			CR8EIX	4218	0.7
175	C1 200	01→04	CR8EB	7784			CR8EIX	4218	0.7
450	G450X	08→	CR9EKB	2305			CR9EIX	3521	0.8
	R45	78→	BP7ES	2412	BP7EVX	7270	BPR7EIX	4055	0.6
600	R60/7	→78	BP7ES	2412	BP7EVX	7270	BPR7EIX	4055	0.6
650	C600 Sport	12→	LMAR8D-J	93444					0.8
	C650 GT	12→	LMAR8D-J	93444					0.8
	F650	94→99	D8EA	2120	DR8EVX	6354	DR8EIX	6681	0.7
	F650ST Strada	97→99	D8EA	2120	DR8EVX	6354	DR8EIX	6681	0.7
	F650GS, GSD	00→02	DR8EB	4855	DR8EVX	6354	DR8EIX	6681	0.7
	F650CS, GS, GS Dakar	02→05	DR8EB	4855	DR8EVX	6354	DR8EIX	6681	0.7
	F650GS, GS Dakar (Single cylinder Twin Spark)	11/05→11/07	DR8EB	4855	DR8EVX	6354	DR8EIX	6681	0.7
	G650GS (Twin Spark)	03/11→	DR8EB	4855	DR8EVX	6354	DR8EIX	6681	0.7
	G650GS Sertão (Twin Spark)	03/12→	DR8EB	4855	DR8EVX	6354	DR8EIX	6681	0.7
	G650 Xchallenge, Xcountry, Xmoto (Twin Spark)	07→	DR8EB	4855	DR8EVX	6354	DR8EIX	6681	0.7
	R65	78→	BP7ES	2412	BP7EVX	7270	BPR7EIX	4055	0.6
	R65/GS		BP6ES	7811	BP6EVX	5832	BPR6EIX	6637	0.6
	R65LS	81→85	BP7ES	2412	BP7EVX	7270	BPR7EIX	4055	0.6
	750	K75	85→97	D7EA	7912				
R75/7			BP7ES	2412	BP7EVX	7270	BPR7EIX	4055	0.6
800	F650GS (Twin cylinder 798cc)	11/07→12	DCPR8E*	4339			DCR8EIX	3606	0.7
	F 700 GS	13→	DCPR8E*	4339			DCR8EIX	3606	0.8
	F800S/ST	05/06→12	DCPR8E*	4339			DCR8EIX	3606	0.8
	F 800 GT	13→	DCPR8E*	4339			DCR8EIX	3606	0.8
	F800GS	11/07→	DCPR8E*	4339			DCR8EIX	3606	0.8
	F800R	05/09→	DCPR8E*	4339			DCR8EIX	3606	0.8
	R80GS	80→94	BP6ES	7811	BP6EVX	5832	BPR6EIX	6637	0.6
	R80RT	82→95	BP6ES	7811	BP6EVX	5832	BPR6EIX	6637	0.6
	R80ST	82→85	BP6ES	7811	BP6EVX	5832	BPR6EIX	6637	0.6
R80TIC	80→85	BP6ES	7811	BP6EVX	5832	BPR6EIX	6637	0.6	
850	R850C, R850GS, R850R	→04/99	BCPR7ET	2164			BKR7EIX	2667	0.8
	R850C, R850GS, R850R	04/99→	BKR7EKC	7354			BKR7EIX	2667	0.8
900	R90/6	73→76	BP6ES	7811	BP6EVX	5832	BPR6EIX	6637	0.6
	R90S	73→76	BP7ES	2412	BP7EVX	7270	BPR7EIX	4055	0.6
1000	K1	89→93	D7EA	7912					0.6
	K100	83→	D7EA	7912					0.6
	K100RS 16 Valve	91→	D7EA	7912					0.6
	R100/7	76→79	BP7ES	2412	BP7EVX	7270	BPR7EIX	4055	0.6
	R100RS, S	76→85	BP7ES	2412	BP7EVX	7270	BPR7EIX	4055	0.6
	R100RT	79→85	BP7ES	2412	BP7EVX	7270	BPR7EIX	4055	0.6
	R100GS, RS, RT (Re-introduced)	87→93	BP6ES	7811	BP6EVX	5832	BPR6EIX	6637	0.6
	S1000RR (Incl. HP4)	12/09→	LMAR9D-J	1633					0.8
1100	K1100LT/SE	92→	DR7EA	7839					0.6
	K1100RS	92→	DR7EA	7839					0.6



* Please note DCPR8E 4339 has a removable terminal nut, whereas DCPR8E 4179 has a fixed terminal nut





CC	MODEL	DATE	STANDARD COPPER CORE	STOCK NUMBER	PLATINUM OR GOLD PALLADIUM	STOCK NUMBER	IRIDIUM	STOCK NUMBER	GAP MM		
BMW (CONTINUED)											
1100	R1100GS	→04/99	BCPR7ET	2164			BKR7EIX	2667	0.8		
	R1100GS	04/99→	BKR7EKC	7354			BKR7EIX	2667	0.8		
	R1100R	95→	BCPR7ET	2164			BKR7EIX	2667	0.8		
	R1100RS/RT	93→	BCPR7ET	2164			BKR7EIX	2667	0.8		
	R1100S	→04/99	BCPR7ET	2164			BKR7EIX	2667	0.8		
	R1100S	04/99→03	BKR7EKC	7354			BKR7EIX	2667	0.8		
	R1100S (Twin Spark)		Ø12mm Plug Ø14mm Plug	03→	DCPR8EKC BKR7EKC	7168 7354	DCPR8EIX BKR7EIX	6546 2667	0.9 0.9		
1130	R1150GS/R/RS/RT	99→03	BKR7EKC	7354			BKR7EIX	2667	0.9		
	R1150GS/R/S (Twin Spark)		Ø12mm Plug Ø14mm Plug	03→	DCPR8EKC BKR7EKC	7168 7354	DCPR8EIX BKR7EIX	6546 2667	0.9 0.9		
1157	K1200R	01/05→					KR9CI	7795	0.8		
	K1200R Sport	11/07→					KR9CI	7795	0.8		
	K1200S	09/04→					KR9CI	7795	0.8		
1170	HP2 Enduro (Twin Spark)		Ø12mm Plug Ø14mm Plug	05→	DCPR8EKC BKR7EKC	7168 7354	DCPR8EIX BKR7EIX	6546 2667	0.9 0.9		
	HP2 Megamoto (Twin Spark)		Ø12mm Plug	07→	DCPR8EKC	7168	DCPR8EIX	6546	0.9		
	HP2 Sport			08→	MAR9B-JDS	1316			0.8		
	K1200GT	03→11/05			DCPR7E	3932	DCPR7EVX	1179	DCPR7EIX	6046	0.8
	K1200GT	01/06→						KR9CI	7795	0.8	
	K1200RS/LT	97→			DCPR7E	3932	DCPR7EVX	1179	DCPR7EIX	6046	0.8
	R1200C Classic, Avantgarde, Independent	97→			BKR7EKC	7354		BKR7EIX	2667	0.9	
	R1200GS (Twin Spark) Ø12mm Plug	04→09			DCPR8EKC	7168		DCPR8EIX	6546	0.9	
	R1200GS (Twin Spark) Ø10mm Plug (19mm Thread Reach)	10→02/13			MAR9B-JDS	8765				0.8	
	R1200GS (Liquid Cooled) (26.5mm Thread Reach)	03/13→			LMAR8D-J	93444				0.8	
	R1200R SOHC (Twin Spark) Ø12mm Plug	06→10			DCPR8EKC	7168		DCPR8EIX	6546	0.9	
	R1200R, Classic DOHC (Twin Spark) Ø10mm Plug	03/11→			MAR9B-JDS	8765				0.8	
	R1200RT (Twin Spark) Ø12mm Plug	03/05→09			DCPR8EKC	7168		DCPR8EIX	6546	0.9	
	R1200RT (Twin Spark) Ø10mm Plug	09→			MAR9B-JDS	8765				0.8	
R1200S (Twin Spark)	06→			DCPR8EKC	7168		DCPR8EIX	6546	0.9		
R1200ST (Twin Spark)	03/05→			DCPR8EKC	7168		DCPR8EIX	6546	0.9		
1293	K1300GT (Incl. Exclusive Edition)	09→					KR9CI	7795	0.8		
	K1300R	09→					KR9CI	7795	0.8		
	K1300S (Incl. HP)	09→					KR9CI	7795	0.8		
1640	K1600GT, GTL	11→					LMAR8AI-8	92288	0.8		

BSA										
50	Beaver, Brigand, Boxer			B6HS	4510			BR6HIX	3419	0.5
	ER1K, Junior, Easy Rider ER1/ER2	80→		BP6ES	7811	BP6EVX	5832	BPR6EIX	6637	0.5
	NVT Models: Easy Rider ER1/2/4, Ranger	80→		BP6ES	7811	BP6EVX	5832	BPR6EIX	6637	0.5
125	Rambler 125, Tracker 125	79→		B9ES	2611	B9EVX	7254	BR9EIX	3981	0.5
175	Rambler 175, Tracker 175, Trials 175	79→		B8ES	2411			BR8EIX	5044	0.5
400	Gold SR 400	99→03		BPR6ES	7822			BPR6EIX	6637	0.7
500	Gold SR 500	99→		BPR7ES	2023			BPR7EIX	4055	0.7
	Victor, B50 Moto-Cross	66→67		B8EG	3430	B8EGV	5627	BR8EIX	5044	0.5
750	A75 and Rocket 3	→75		B8ES	2411			BR8EIX	5044	0.6

BUELL											
984	Firebolt XB9R	02→		DCPR9E	2641	DCPR9EVX	6436	DCPR9EIX	2316	0.9	
	Lightning CityX XB9SX	05→		DCPR9E	2641	DCPR9EVX	6436	DCPR9EIX	2316	0.9	
	Lightning XB9S	02→		DCPR9E	2641	DCPR9EVX	6436	DCPR9EIX	2316	0.9	
	XB9X (City X)	09→		DCPR9E	2641	DCPR9EVX	6436	DCPR9EIX	2316	0.9	
1125	1125R	08→		CR9EKB	2305			CR9EIX	3521	0.8	
	1125CR (Café Racer)	09→		CR9EKB	2305			CR9EIX	3521	0.8	
1200	Firebolt XB12R	03→		DCPR9E	2641	DCPR9EVX	6436	DCPR9EIX	2316	0.9	
	Lightning XB12S/Ss	04→		DCPR9E	2641	DCPR9EVX	6436	DCPR9EIX	2316	0.9	
	Lightning XB12Scg	06→		DCPR9E	2641	DCPR9EVX	6436	DCPR9EIX	2316	0.9	
	Lightning XB12STT	07→		DCPR9E	2641	DCPR9EVX	6436	DCPR9EIX	2316	0.9	
	M2 Cyclone	97→03			DCPR9E	2641	DCPR9EVX	6436	DCPR9EIX	2316	0.9
	S1 Lightning	97→99			DCPR9E	2641	DCPR9EVX	6436	DCPR9EIX	2316	0.9
	S1W White Lightning	1998			DCPR9E	2641	DCPR9EVX	6436	DCPR9EIX	2316	0.9
	S3 Thunderbolt	97→99			DCPR9E	2641	DCPR9EVX	6436	DCPR9EIX	2316	0.9
	Ulysses XB12X	05→			DCPR9E	2641	DCPR9EVX	6436	DCPR9EIX	2316	0.9
	X1 Lightning	99→03			DCPR9E	2641	DCPR9EVX	6436	DCPR9EIX	2316	0.9



CC	MODEL	DATE	STANDARD COPPER CORE	STOCK NUMBER	PLATINUM OR GOLD PALLADIUM	STOCK NUMBER	IRIDIUM	STOCK NUMBER	GAP MM
CAGIVA									
50	City 50	94→	BPR8HS	3725			BPR8HIX	6742	0.5
	Mito 50 (Standard)	98→	B9ES	2611	B9EVX	7254	BR9EIX	3981	0.5
	Prima 50	92→	B8ES	2411			BR8EIX	5044	0.5
	Supercity 50	92→	B8ES	2411			BR8EIX	5044	0.5
	W4 50	92→	B8ES	2411			BR8EIX	5044	0.5
75	Prima 80	92→	B8ES	2411			BR8EIX	5044	0.5
	Supercity 80	92→	B8ES	2411			BR8EIX	5044	0.5
	W4 80	92→	B8ES	2411			BR8EIX	5044	0.5
125	Blues 125	91→93			B95EGV	2145			0.5
	Freccia C12/C12R	89→	B9ES	2611	B9EVX	7254	BR9EIX	3981	0.5
	K7	90→			B95EGV	2145			0.5
	Mito 125	91→	BR9EG	3230			BR9EIX	3981	0.6
	Mito 125 (Race)				B95EGV	2145			0.7
	Mito (Le Lawson)	92→			B95EGV	2145			0.5
	Mito 525SP	04/08→	BR9EG	3230			BR9EIX	3981	0.6
	Planet 125	98→			B95EGV	2145			0.6
	Raptor (2-Stroke)	04→	BR9EG	3230			BR9EIX	3981	0.6
	Roadster 125	92→	B9ES	2611	B9EVX	7254	BR9EIX	3981	0.6
	Super City 125	→02/95	B9EG	3530	B9EGV	5827	BR9EIX	3981	0.5
	Super City 125	06/98→			B95EGV	2145			0.6
	W8 125	→12/92	B9EG	3530	B9EGV	5827	BR9EIX	3981	0.6
	W8 125	07/98→	B9ES	2611	B9EVX	7254	BR9EIX	3981	0.6
	WMX 125		B10EG	3630	B10EGV	5927	BR10EIX	6801	0.5
WSXT 125	82→	B9EG	3530	B9EGV	5827	BR9EIX	3981	0.5	
250	SST 250	81→	B8ES	2411			BR8EIX	5044	0.5
	WMX 250				B95EGV	2145			0.5
350	Indiana 350		BP7HS	5111			BPR7HIX	5944	0.5
	W12 350	93→	DPR8EA-9	4929			DPR8EIX-9	2202	0.6
500	Canyon 500	02/98→	DCPR8E*	4179			DCR8EIX	3606	0.6
	River 500	99→	DCPR8E*	4179			DCR8EIX	3606	0.6
600	Canyon 600	→03/97	BCP7ES	5030	BCP7EVX	7681	BCPR7EIX	5690	0.8
	River 600	95→	BCP7ES	5030	BCP7EVX	7681	BCPR7EIX	5690	0.8
	W16 600	→95	C7E	5096			CR7EIX	7385	0.6
	W16 600	95→	BCP7ES	5030	BCP7EVX	7681	BCPR7EIX	5690	0.8
650	Alazzurra 650	85→88	BP7HS	5111			BPR7HIX	5944	0.5
	Indiana 650		BP7HS	5111			BPR7HIX	5944	0.5
	Raptor	00→	CR8E	1275			CR8EIX	4218	0.7
	V Raptor	00→	CR8E	1275			CR8EIX	4218	0.7
750	Elefant 750	87→	DPR8EA-9	4929			DPR8EIX-9	2202	0.6
	Indiana 750		BP7HS	5111			BPR7HIX	5944	0.5
900	900GT	91→	DR9EA	3437	DR9EVX	6361	DR9EIX	4772	0.5
	900 i.e.	91→	DR9EA	3437	DR9EVX	6361	DR9EIX	4772	0.5
	Elefant 900	91→	DPR8EA-9	4929			DPR8EIX-9	2202	0.9
	Gran Canyon	99→	DCPR8E*	4179			DCR8EIX	3606	0.6
1000	Navigator/T	00→	CR8EK	3478			CR8EIX	4218	0.7
	Raptor	00→	CR8EK	3478			CR8EIX	4218	0.7
	V Raptor	00→	CR8EK	3478			CR8EIX	4218	0.7
	Xtra Raptor	02→	CR8EK	3478			CR8EIX	4218	0.7

CCM (ARMSTRONG-CCM)									
125	CMX 125 L/C	83→85	B9EG	3530	B9EGV	5827	BR9EIX	3981	0.5
	Moto-X Hiro 125	79→80	B10EG	3630	B10EGV	5927	BR10EIX	6801	0.5
240	Trials CMT 240		BP5ES	6511			BPR5EIX	6597	0.5
250	CMT 250 Trials		BP5ES	6511			BPR5EIX	6597	0.5
	CMX 250 1982	1982	B8EG	3430	B8EGV	5627	BR8EIX	5044	0.5
	CMX 250, 250 L/C	83→85	B9EG	3530	B9EGV	5827	BR9EIX	3981	0.5
	Moto-X Hiro 250	79→81	B9EG	3530	B9EGV	5827	BR9EIX	3981	0.5
310	CMT 310 Trials		BP5ES	6511			BPR5EIX	6597	0.5
320	CMT 320 Trials		BP5ES	6511			BPR5EIX	6597	0.5



* Please note DCPR8E 4339 has a removable terminal nut, whereas DCPR8E 4179 has a fixed terminal nut





CC	MODEL	DATE	STANDARD COPPER CORE	STOCK NUMBER	PLATINUM OR GOLD PALLADIUM	STOCK NUMBER	IRIDIUM	STOCK NUMBER	GAP MM
CCM (ARMSTRONG-CCM) (CONTINUED)									
350	350 Trials	1978	B6ES	7310					0.5
	CMT 350 Trials		BP5ES	6511			BPR5EIX	6597	0.5
400	404E/DS	03→	CR8E	1275			CR8EIX	4218	0.7
	404XC-Trail		CR8E	1275			CR8EIX	4218	0.7
	FT35	05→	CR8E	1275			CR8EIX	4218	0.7
	R35	06→	CR8E	1275			CR8EIX	4218	0.7
	SR40	07→	CR8E	1275			CR8EIX	4218	0.7
434	R35 Factory Big Bore Conversion	06→	CR8E	1275			CR8EIX	4218	0.7
450	CMX 450	82→	B8EG	3430	B8EGV	5627	BR8EIX	5044	0.5
490	CMX 490		B8EG	3430	B8EGV	5627	BR8EIX	5044	0.5
500	CMX 500 (4-Stroke)		D8EA	2120	DR8EVX	6354	DR8EIX	6681	0.5
	Moto-X (4-Stroke) 2 valve models	72→79	B8EG	3430	B8EGV	5627	BR8EIX	5044	0.5
	Moto-X (4-Stroke) 4 valve models	79→81					CR8EIX	4218	0.5
	MTT 500		D8EA	2120	DR8EVX	6354	DR8EIX	6681	0.5
560	CCM 560		D8EA	2120	DR8EVX	6354	DR8EIX	6681	0.5
	CMX 560 (4-Stroke)		D8EA	2120	DR8EVX	6354	DR8EIX	6681	0.5
600	604E Sport & Supermoto		D8EA	2120	DR8EVX	6354	DR8EIX	6681	0.5
	604R / RS / R30		D8EA	2120	DR8EVX	6354	DR8EIX	6681	0.5
640	640 RS (Rotax engine)		D8EA	2120	DR8EVX	6354	DR8EIX	6681	0.5
644	644 (Suzuki engine)	02→	CR10E	6264			CR10EIX	6482	0.7
	R30 (Suzuki engine)	05→	CR10E	6264			CR10EIX	6482	0.7
710	R30 (Suzuki engine)	05→	CR10E	6264			CR10EIX	6482	0.7

CF MOTO									
250	V3 Auto 250T-3	07→	DPR8EA-9	4929			DPR8EIX-9	2202	0.9
	V5 Auto 250T-5		DPR8EA-9	4929			DPR8EIX-9	2202	0.9

COSSACK									
350	Jupiter	73→79	BR6HS	3922			BR6HIX	3419	0.6
	Planeta	73→79	BR6HS	3922			BR6HIX	3419	0.6
650	Dnepr, Ural	73→79	BR6HS	3922			BR6HIX	3419	0.6

CPI									
50	Aragon 50	06→	BR7ES	5122			BR7EIX	6664	0.7
	Aragon GP50	06→	BR7ES	5122			BR7EIX	6664	0.7
	Formula R (Euro 1, 12.7mm Thread Reach)	→05	BR7HS	4122			BR7HIX	7067	0.7
	Formula R (Euro 2, 19mm Thread Reach)	06→	BR7ES	5122			BR7EIX	6664	0.7
	GTR 50 (12.7mm Thread Reach)	03→04	BR7HS	4122			BR7HIX	7067	0.7
	GTR 50 (19mm Thread Reach)	05→	BR10EG	3830			BR10EIX	6801	0.6
	GTS 50 (12.7mm Thread Reach)	03→04	BR7HS	4122			BR7HIX	7067	0.7
	GTS 50 (19mm Thread Reach)	05→	BR10EG	3830			BR10EIX	6801	0.6
	Hussar 50, Mars JP50, Baby J 50 (Euro 1)		BR8HSA	5539			BPR8HIX	6742	0.6
	Hussar 50 (Euro 2)	03→	BR7ES	5122			BR7EIX	6664	0.7
	Oliver 50 (Euro 2)	03→	BR7ES	5122			BR7EIX	6664	0.7
	Popcorn 50 (Euro 2)	03→	BR7ES	5122			BR7EIX	6664	0.7
	Supercross 50 (Euro 1, 12.7mm Thread Reach)		BR7HS	4122			BR7HIX	7067	0.7
	Supercross 50 (Euro 2, 19mm Thread Reach)	03→	BR7ES	5122			BR7EIX	6664	0.7
	Supermoto 50 (Euro 1, 12.7mm Thread Reach)		BR7HS	4122			BR7HIX	7067	0.7
	Supermoto 50 (Euro 2, 19mm Thread Reach)	03→	BR7ES	5122			BR7EIX	6664	0.7
125	GTS 125		BR7HS	4122			BR7HIX	7067	0.7
	Hussar JU 125	04→	CR7HSA	4549			CR7HIX	7544	0.6
	QT4A ARN 125		CR7HSA	4549			CR7HIX	7544	0.6
	X-Large 125		BR7HS	4122			BR7HIX	7067	0.7
150	GTS 150		BR7HS	4122			BR7HIX	7067	0.7
	X-Large 150		BR7HS	4122			BR7HIX	7067	0.7
200	GTS 200		BR7HS	4122			BR7HIX	7067	0.7
	X-Large 200		BR7HS	4122			BR7HIX	7067	0.7



CC	MODEL	DATE	STANDARD COPPER CORE	STOCK NUMBER	PLATINUM OR GOLD PALLADIUM	STOCK NUMBER	IRIDIUM	STOCK NUMBER	GAP MM
DAELIM									
50	Cordi	04→	BPR6HS	7022			BPR6HIX	4085	0.6
	E Five	03→	B8HS	5510	B8HVX	2634	BR8HIX	7001	0.7
	Message 49	98→	BR8HSA	5539			BPR8HIX	6742	0.7
	S Five	02→	B8HS	5510	B8HVX	2634	BR8HIX	7001	0.7
100	Delpino 100	99→	B8HS	5510	B8HVX	2634	BR8HIX	7001	0.7
110	Citi Ace 110	03→	C7HSA	4629			CR7HIX	7544	0.7
125	Altino NF125ES	03→	CR8EH-9	5666			CR8EHIX-9	3797	0.9
	History 125	04→	CR8EH-9	5666			CR8EHIX-9	3797	0.9
	NS125 Trans Eagle	98→	CR8EH-9	5666			CR8EHIX-9	3797	0.9
	Roadwin (Incl. R)	04→	CR8EH-9	5666			CR8EHIX-9	3797	0.9
	VEE125		CR8EH-9	5666			CR8EHIX-9	3797	0.9
	VL125 Daystar		CR8EH-9	5666			CR8EHIX-9	3797	0.9
	VS125	97→	CR8EH-9	5666			CR8EHIX-9	3797	0.9
250	VJF250 (Roadwin)	12→	CR9EH-9	7502			CR9EHIX-9	6216	0.9

DERBI									
50	Atlantis 50 (4-Stroke)	04→	CR8EB	7784			CR8EIX	4218	0.7
	Atlantis 50 (Air Cooled, 12.7mm Thread Reach)	99→02	B8HS	5510	B8HVX	2634	BR8HIX	7001	0.5
	Atlantis 50 (Air Cooled, 19mm Thread Reach)	03→	BR9ES	5722			BR9EIX	3981	0.6
	Atlantis 50 (Liquid Cooled)	00→	BR9ES	5722			BR9EIX	3981	0.6
	Black Devil	03→	B8ES	2411			BR8EIX	5044	0.6
	Black Edition	03→	B8ES	2411			BR8EIX	5044	0.6
	Black Mini	03→	CR9E	6263			CR9EIX	3521	0.6
	Dirt Boy, Dirt Kid	03→	CR9E	6263			CR9EIX	3521	0.6
	DRD 50 Supermoto	02→	B8ES	2411			BR8EIX	5044	0.5
	GP1	03→	BR10ES	4832			BR10EIX	6801	0.7
	GPR 50-R	97→	B8ES	2411			BR8EIX	5044	0.5
	GPR 50 (Standard power)	02→09	B8ES	2411			BR8EIX	5044	0.5
	GPR 50 (Full power)	02→	B9ES	2611	B9EVX	7254	BR9EIX	3981	0.6
	GPR 50	10→	BR8ES	5422			BR8EIX	5044	0.6
	Hunter	96→98	B8HS	5510	B8HVX	2634	BR8HIX	7001	0.5
	Predator LC	98→	B8ES	2411			BR8EIX	5044	0.5
	Senda 50 / R / SM (Standard power)	95→	B8ES	2411			BR8EIX	5044	0.5
	Senda 50 / R / SM (Full power)	95→	B9ES	2611	B9EVX	7254	BR9EIX	3981	0.6
Vamos	95→97	B8HS	5510	B8HVX	2634	BR8HIX	7001	0.5	
85	Atlantis 100	00→	BR9ES	5722			BR9EIX	3981	0.7
	Senda 100	97→	B9ES	2611	B9EVX	7254	BR9EIX	3981	0.6
125	Boulevard 125 4T	03→	CPR8E	7411			CR8EIX	4218	0.6
	Cross City 125	07→	D8EA	2120	DR8EVX	6354	DR8EIX	6681	0.8
	GP1 125	06→	CR9EB	6955			CR9EIX	3521	0.6
	GPR 125 (Yamaha engine)	04→09	BR8ES	5422			BR8EIX	5044	0.7
	GPR 125	10→	CR8EB	7784			CR8EIX	4218	0.7
	HDR Cabriolet 125	00→	CR7E	4578			CR7EIX	7385	0.5
	Mulhacén Café 125	07→	CR8EB	7784			CR8EIX	4218	0.7
	Senda 125 4T (Honda engine)	03→	DPR8EA-9	4929			DPR8EIX-9	2202	0.7
Senda Baja R 125	07→	D8EA	2120	DR8EVX	6354	DR8EIX	6681	0.8	
150	Boulevard 150 4T	03→	CPR8E	7411			CR8EIX	4218	0.6
250	GP1 250	06→	CR9EB	6955			CR9EIX	3521	0.6
300	Rambla 300i	10→	CR8EKB	4374			CR8EIX	4218	0.7
660	Mulhacén 659 / Café	06→	CR7E	4578			CR7EIX	7385	0.5

DUCATI									
250	250 Desmo, Monza, Sebring		B6HS	4510			BR6HIX	3419	0.5
350	350 Desmo, Sebring		B6HS	4510			BR6HIX	3419	0.5
	350 Sport	91→	BP7HS	5111			BPR7HIX	5944	0.6
400	400 SS, Junior	91→94	BP7HS	5111			BPR7HIX	5944	0.6
450	450 Desmo, Sebring		B6HS	4510			BR6HIX	3419	0.5
500	500 Desmo	78→83	B6HS	4510			BR6HIX	3419	0.5
	500 Pantah	80→84	BP7HS	5111			BPR7HIX	5944	0.6

2 Wheel



CC	MODEL	DATE	STANDARD COPPER CORE	STOCK NUMBER	PLATINUM OR GOLD PALLADIUM	STOCK NUMBER	IRIDIUM	STOCK NUMBER	GAP MM
DUCATI (CONTINUED)									
600	600 Monster, Monster S, Monster Dark	94→01					DCR8EIX	3606	0.7
	600 Pantah	80→85	BP7HS	5111			BPR7HIX	5944	0.6
	600 SS	→94	DCPR8E*	4339			DCR8EIX	3606	0.7
	600 SS	94→98	DCPR8E*	4339			DCR8EIX	3606	0.7
620	620 i.e., S i.e. & i.e. Dark	02→	DCPR8E*	4339			DCR8EIX	3606	0.7
	Multistrada 620	04→	DCPR8E*	4339			DCR8EIX	3606	0.7
650	Indiana 650	86→88	BP7HS	5111			BPR7HIX	5944	0.6
695	Monster 695	06→08	DCPR8E*	4339			DCR8EIX	3606	0.7
696	Monster 696	08→	DCPR8E*	4339			DCR8EIX	3606	0.7
748	748, 748 Biposto	95→04					DCR9EIX	6650	0.6
	Dark	04→06	CR9EB	6955			CR9EIX	3521	0.6
	748 R	00→04	R2349-10	6839					0.6
	748 S	00→04					DCR9EIX	6650	0.6
	748 SP	95→98	R2349-10	6839					0.6
	748 SPS	98→00	R2349-10	6839					0.6
	749 (‡ Socket Ø <20.5mm)	02→06	CR9EB	6955			CR9EIX	3521	0.6
	749, R, S (‡ Socket Ø <20.5mm)	03→06	CR9EB	6955			CR9EIX	3521	0.6
750	750 F1	86→88	BP7HS	5111			BPR7HIX	5944	0.6
	750 F1	89→	DCPR8E*	4339			DCR8EIX	3606	0.7
	750 GT		B7HS	5110			BR7HIX	7067	0.5
	750 Monster	96→	DCPR8E*	4339			DCR8EIX	3606	0.7
	750 Montjuich		BP7HS	5111			BPR7HIX	5944	0.6
	750 Paso	86→90	DCPR8E*	4339			DCR8EIX	3606	0.7
	750 Sport		DCPR8E*	4339			DCR8EIX	3606	0.7
	750 SS	→90	B7HS	5110			BR7HIX	7067	0.5
	750 SS	91→	DCPR8E*	4339			DCR8EIX	3606	0.7
	750 SS i.e.	98→	DCPR8E*	4339			DCR8EIX	3606	0.7
803	800 Sport	03→	DCPR8E*	4339			DCR8EIX	3606	0.7
	800 i.e. Monster	03→05	DCPR8E*	4339			DCR8EIX	3606	0.7
	Hypermotard 796 (Twin Spark)	10→12	DCPR8E*	4339			DCR8EIX	3606	0.7
	Monster 796	10→	DCPR8E*	4339			DCR8EIX	3606	0.7
	S2R 800	05→08	DCPR8E*	4339			DCR8EIX	3606	0.7
	SS 800	03→	DCPR8E*	4339			DCR8EIX	3606	0.7
821	Hypermotard	13→	MAR9A-J	6869					0.8
	Hyperstrada	13→	MAR9A-J	6869					0.8
849	848	08→	MAR10A-J	4706					0.8
	848 Evo, Evo Dark Stealth, Corse SE	07/10→	MAR10A-J	4706					0.8
	Streetfighter 848	11/11→	MAR10A-J	4706					0.8
851	851				DR9EVX	6361	DR9EIX	4772	0.6
	851 Strada	89→92			DR9EVX	6361	DR9EIX	4772	0.6
860	860 GT, GTS		B5HS	4210					0.6
888	851 SP (Sport Production)	90→92			DR9EVX	6361	DR9EIX	4772	0.6
	888 SP (Sport Production)	92→94					DCR9EIX	6650	0.8
	888 Strada	→93			DR9EVX	6361	DR9EIX	4772	0.6
	888 Strada	94→	DR9EA	3437	DR9EVX	6361	DR9EIX	4772	0.6
900	900 Darmah SS, SD		B6HS	4510			BR6HIX	3419	0.5
	900 i.e. Monster, Monster Dark	99→	DCPR8E*	4339			DCR8EIX	3606	0.9
	900 Injection		DCPR8E*	4339			DCR8EIX	3606	0.9
	900 Monster, Monster S	97→	DCPR8E*	4339			DCR8EIX	3606	0.9
	900 SS, SSD, S2, Hailwood Replica	79→	B7HS	5110			BR7HIX	7067	0.6
	900 SS	91→	DCPR8E*	4339			DCR8EIX	3606	0.9
	900 Superlight	92→	DCPR8E*	4339			DCR8EIX	3606	0.9
	900 Supersport, FE	97→	DCPR8E*	4339			DCR8EIX	3606	0.9
	906 Paso	88→94	DCPR8E*	4339			DCR8EIX	3606	0.9
	907 I.E.	91→	DCPR8E*	4339			DCR8EIX	3606	0.9
916	916 (All models except SP)	94→					DCR9EIX	6650	0.8
	916 SP	94→	R2349-10	6839					0.6

‡ Early Ducati Testastretta bikes (749, 998, 999 models) can have very little clearance between the plug hex and the cylinder head that may require a thin walled socket, no larger than 20.5mm OD to allow the plug to be fitted.



* Please note DCPR8E 4339 has a removable terminal nut, whereas DCPR8E 4179 has a fixed terminal nut





CC	MODEL	DATE	STANDARD COPPER CORE	STOCK NUMBER	PLATINUM OR GOLD PALLADIUM	STOCK NUMBER	IRIDIUM	STOCK NUMBER	GAP MM
DUCATI (CONTINUED)									
916	916 SPS Fogarty Replica	98→	R2349-10	6839					0.6
	S4 Monster	01→					DCR9EIX	6650	0.8
	ST4	98→03					DCR9EIX	6650	0.7
944	ST2	97→03					DCR9EIX	6650	0.8
989	Desmosedici RR	07→	MAR10A-J	4706					0.8
992	GT1000 (Twin Spark)	06→	DCPR8E*	4339			DCR8EIX	3606	0.9
	Monster 1000 i.e. (Twin Spark)	03→	DCPR8E*	4339			DCR8EIX	3606	0.9
	Multistrada 1000DS, MTS 1000DS (Twin Spark)	03→	DCPR8E*	4339			DCR8EIX	3606	0.9
	Paul Smart 1000 Limited Edition (Twin Spark)	05→06	DCPR8E*	4339			DCR8EIX	3606	0.9
	Monster S2R, Dark 1000 (Twin Spark)	10/05→	DCPR8E*	4339			DCR8EIX	3606	0.9
	Sport 1000 (Twin Spark)	05→	DCPR8E*	4339			DCR8EIX	3606	0.9
	SS 1000 DS (Twin Spark)	03→06	DCPR8E*	4339			DCR8EIX	3606	0.9
	ST3 (Twin Spark)	03→07	CR9EB	6955			CR9EIX	3521	0.6
996	996 B/S, Biposto	98→					DCR9EIX	6650	0.8
	996 S	00→02					DCR9EIX	6650	0.8
	996 SPS	97→02	R2349-10	6839					0.6
	S4R Monster	03→06					DCR9EIX	6650	0.8
	ST4S	00→					DCR9EIX	6650	0.8
998	996 R (‡ Socket Ø <20.5mm)	00→02	CR9EB	6955			CR9EIX	3521	0.6
	998 Biposto, R, S (‡ Socket Ø <20.5mm)	01→	CR9EB	6955			CR9EIX	3521	0.6
	998 Matrix (‡ Socket Ø <20.5mm)	2003	CR9EB	6955			CR9EIX	3521	0.6
	999, R, S (‡ Socket Ø <20.5mm)	02→06	CR9EB	6955			CR9EIX	3521	0.6
	S4RS Monster (‡ Socket Ø <20.5mm)	06→08	CR9EB	6955			CR9EIX	3521	0.6
	S4R Monster (‡ Socket Ø <20.5mm)	07→	CR9EB	6955			CR9EIX	3521	0.6
1078	Hypermotard, S, Evo, Evo SP	07→	DCPR8E*	4339			DCR8EIX	3606	0.9
	Monster 1100, S, Evo, Diesel	09→	DCPR8E*	4339			DCR8EIX	3606	0.9
	Multistrada 1100, S	06→	DCPR8E*	4339			DCR8EIX	3606	0.9
1098	1098, 1098S / Tricolore	07→	MAR10A-J	4706					0.8
	Streetfighter S	09→	MAR10A-J	4706					0.8
1198	1098R (Incl. Bayliss LE)	08→	MAR10A-J	4706					0.8
	1198, S, SP	09→	MAR10A-J	4706					0.8
	1199 Panigale, R, S, S Tricolore	12→	MAR9A-J	6869					0.8
	Diavel (Incl. AMG, Carbon & Cromo)	11→	MAR9A-J	6869					0.8
	Multistrada 1200, S (Incl. Pikes Peak, Sport & Touring)	10→12	MAR9A-J	6869					0.8
	Multistrada 1200, S (Incl. Pikes Peak, Sport & Touring) Twin Spark	13→	MAR10A-J	4706					0.8

FANTIC									
50	Gran Turismo, Lei 50, Issimo (all models)		B6HS	4510			BR6HIX	3419	0.5
	Trial 50		B7HS	5110			BR7HIX	7067	0.5
80	Caballero 80		B8EG	3430	B8EGV	5627	BR8EIX	5044	0.5
	Enduro 80		B8EG	3430	B8EGV	5627	BR8EIX	5044	0.5
	RSX 80		B8EG	3430	B8EGV	5627	BR8EIX	5044	0.5
	Section	95→97	BCP7ES	5030	BCP7EVX	7681	BCPR7EIX	5690	0.5
125	Caballero 125		B9EG	3530	B9EGV	5827	BR9EIX	3981	0.5
	Cross 125		B9EG	3530	B9EGV	5827	BR9EIX	3981	0.5
	Professional 125		B6HS	4510			BR6HIX	3419	0.5
	RSX 125		B9EG	3530	B9EGV	5827	BR9EIX	3981	0.5
	Trial 125		B6HS	4510			BR6HIX	3419	0.5
160	TX160		B8EG	3430	B8EGV	5627	BR8EIX	5044	0.5
175	Enduro 175		B8EG	3430	B8EGV	5627	BR8EIX	5044	0.5
200	Trial 200		B6HS	4510			BR6HIX	3419	0.5
240	Trial 240		B6HS	4510			BR6HIX	3419	0.5
250	K Roo	91→94	BL-6H	6921					0.5
	Section	95→97	BCP7ES	5030	BCP7EVX	7681	BCPR7EIX	5690	0.5
	TX250		B8EG	3430	B8EGV	5627	BR8EIX	5044	0.5
260	TX260		B8EG	3430	B8EGV	5627	BR8EIX	5044	0.5
300	Professional 300		B8EG	3430	B8EGV	5627	BR8EIX	5044	0.5
330	TX330		B8EG	3430	B8EGV	5627	BR8EIX	5044	0.5

‡ Early Ducati Testastretta bikes (749, 998, 999 models) can have very little clearance between the plug hex and the cylinder head that may require a thin walled socket, no larger than 20.5mm OD to allow the plug to be fitted.



* Please note DCPR8E 4339 has a removable terminal nut, whereas DCPR8E 4179 has a fixed terminal nut





CC	MODEL	DATE	STANDARD COPPER CORE	STOCK NUMBER	PLATINUM OR GOLD PALLADIUM	STOCK NUMBER	IRIDIUM	STOCK NUMBER	GAP MM
GAS GAS									
50	Contact, Endurocross		B8HS	5510	B8HVX	2634	BR8HIX	7001	0.5
	EC 50 Boy (12.7mm Thread Reach)		B8HS	5510	B8HVX	2634	BR8HIX	7001	0.5
	EC Boy, Rookie 50 (19mm Thread Reach)	04→	B9ES	2611	B9EVX	7254	BR9EIX	3981	0.6
	SM 50 Supermotard	04→	B9ES	2611	B9EVX	7254	BR9EIX	3981	0.6
	TXT Boy		BPR5ES	7422			BPR5EIX	6597	0.5
65	MC65	06→	BR10ES	4832			BR10EIX	6801	0.7
75	Husqvarna (TM)		B10EG	3630	B10EGV	5927	BR10EIX	6801	0.5
80	TXT 80		BPR5ES	7422			BPR5EIX	6597	0.5
125	Contact T12		BP5ES	6511			BPR5EIX	6597	0.5
	EC 125 Endurocross	97→	B9EG	3530	B9EGV	5827	BR9EIX	3981	0.7
	EC 125 Racing, EC 125 SIX	10→	BR9EG	3230			BR9EIX	3981	0.7
	Enduro 125	02→	BR8EG	3130			BR8EIX	5044	0.5
	Endurocross TT125, Cross TT125				B10EGV	5927	BR10EIX	6801	0.5
	GT12 (Liquid Cooled)		BP5ES	6511			BPR5EIX	6597	0.5
	Husqvarna (TM)		B10EG	3630	B10EGV	5927	BR10EIX	6801	0.5
	Pampera 125		BPR5ES	7422			BPR5EIX	6597	0.5
	SM 125 Supermotard		BR9EG	3230			BR9EIX	3981	0.7
	Trial 125		BP5ES	6511			BPR5EIX	6597	0.5
	TX, TXT 125 Ø14mm Plug	99→	BPR5ES	7422			BPR5EIX	6597	0.5
	TX Randonne Ø10mm Plug	11→	CR6HSA	2983			CR6HIX	7274	0.6
	TXT Pro, Racing	11→	BPR5ES	7422			BPR5EIX	6597	0.6
143	Contact T16		BP5ES	6511			BPR5EIX	6597	0.5
160	GT16 (Liquid Cooled)		BP5ES	6511			BPR5EIX	6597	0.5
200	EC 200 Endurocross	99→			B10EGV	5927	BR10EIX	6801	0.6
	EC 200 Endurocross (2002 models)	02→	BR8EG	3130			BR8EIX	5044	0.5
	EC 200 Racing	11→	BR8EG	3130			BR8EIX	5044	0.7
	Trial 200		BP5ES	6511			BPR5EIX	6597	0.5
	TX, TXT 200	99→	BPR5ES	7422			BPR5EIX	6597	0.5
238	Contact JT25		BP5ES	6511			BPR5EIX	6597	0.5
249	TX, TXT 249	99→	BPR5ES	7422			BPR5EIX	6597	0.5
250	Delta 25 GT		BP5ES	6511			BPR5EIX	6597	0.5
	EC 250 Endurocross	97→	B8EG	3430	B8EGV	5627	BR8EIX	5044	0.5
	EC 250 Racing, EC 250 SIX (Incl. Replica) (2-Stroke)	10→	BR8EG	3130			BR8EIX	5044	0.7
	ECF250 4T, ECF250 SIX (4-Stroke)	10→11	CR8E	1275			CR8EIX	4218	0.7
	ECF250 4T, ECF250 SIX (4-Stroke)	12→	CR9E	6263			CR9EIX	3521	0.6
	Enduro 250	02→	BR8EG	3130			BR8EIX	5044	0.5
	Endurocross 250				B10EGV	5927	BR10EIX	6801	0.5
	Husqvarna (TM)		B10EG	3630	B10EGV	5927	BR10EIX	6801	0.5
	Pampera 250		BPR5ES	7422			BPR5EIX	6597	0.5
	Supermotard SM 250		BR8EG	3130			BR8EIX	5044	0.5
Trial 250 (Air & Liquid Cooled models)		BP5ES	6511			BPR5EIX	6597	0.5	
TXT Pro, Raga Replica	03→	BPR5ES	7422			BPR5EIX	6597	0.6	
270	TX, TXT 270		BP5ES	6511			BPR5EIX	6597	0.5
280	Pampera 280		BPR5ES	7422			BPR5EIX	6597	0.5
	Trial 280		BP5ES	6511			BPR5EIX	6597	0.5
	TX, TXT 280		BPR5ES	7422			BPR5EIX	6597	0.5
	TXT Pro, Racing, Raga Replica	11→	BPR5ES	7422			BPR5EIX	6597	0.6
300	EC 300 Endurocross				B10EGV	5927	BR10EIX	6801	0.6
	EC 300 Racing, EC 300 SIX (Incl. Replica) (2-Stroke)	10→	BR8EG	3130			BR8EIX	5044	0.7
	Enduro 300	02→	BR8EG	3130			BR8EIX	5044	0.5
	Trial 300		BP5ES	6511			BPR5EIX	6597	0.5
	TXT 300		BPR5ES	7422			BPR5EIX	6597	0.5
	TXT Pro, Racing, Raga Replica	11→	BPR5ES	7422			BPR5EIX	6597	0.6
321	TX, TXT 321	99→	BP5ES	6511			BPR5EIX	6597	0.5
325	Trial Halley PXC 325		B9ES	2611	B9EVX	7254	BR9EIX	3981	0.5
327	Trial 327		BP5ES	6511			BPR5EIX	6597	0.5
330	Delta 32 GT		BP5ES	6511			BPR5EIX	6597	0.5
400	Pampera 400	06→	CR8E	1275			CR8EIX	4218	0.7
	SM 400FSE-4T	02→	CR8E	1275			CR8EIX	4218	0.7
450	EC 450 (4-Stroke)	08→10	CR8E	1275			CR8EIX	4218	0.7
	FSE 450	03→	CR8E	1275			CR8EIX	4218	0.7
	SM 450	04→	CR8E	1275			CR8EIX	4218	0.7
492	EC 515 FSR	08→10	CR8E	1275			CR8EIX	4218	0.7
	SM 515	08→10	CR8E	1275			CR8EIX	4218	0.7
500	Normada 500		D8EA	2120	DR8EVX	6354	DR8EIX	6681	0.5



CC	MODEL	DATE	STANDARD COPPER CORE	STOCK NUMBER	PLATINUM OR GOLD PALLADIUM	STOCK NUMBER	IRIDIUM	STOCK NUMBER	GAP MM
GENERIC									
50	Cracker 50	07→	BR7ES	5122			BR7EIX	6664	0.7
	Evolution 50	07→	BR7ES	5122			BR7EIX	6664	0.7
	Ideo 50	07→	BR7ES	5122			BR7EIX	6664	0.7
	Race 50 (19mm Thread Reach)	→11	BR7ES	5122			BR7EIX	6664	0.7
	Race 50 (12.7mm Thread Reach)	11→	BR8HSA	5539			BPR8HIX	6742	0.7
	ROC 50		BR7ES	5122			BR7EIX	6664	0.7
	Trigger SM 50	07→	BR7ES	5122			BR7EIX	6664	0.7
	Trigger SM Competition (Restricted)		BR7ES	5122			BR7EIX	6664	0.7
	Trigger SM Competition (Unrestricted)		BR9ES	5722			BR9EIX	3981	0.7
	Trigger X 50	07→	BR7ES	5122			BR7EIX	6664	0.7
	Trigger X Competition (Restricted)		BR7ES	5122			BR7EIX	6664	0.7
	Trigger X Competition (Unrestricted)		BR9ES	5722			BR9EIX	3981	0.7
	XOR 50	07→	BR7ES	5122			BR7EIX	6664	0.7
	XOR 50 Competition	07→	BR7ES	5122			BR7EIX	6664	0.7
XOR Stroke 50 (2-Stroke)	07→	BR7ES	5122			BR7EIX	6664	0.7	
XOR 50 Williams		BR7ES	5122			BR7EIX	6664	0.7	
125	Soho 125	09→	CR8E	1275			CR8EIX	4218	0.7
	XOR 125	07→	CR7HSA	4549			CR7HIX	7544	0.7
	XOR 125 Williams	08→	CR7HSA	4549			CR7HIX	7544	0.7

GILERA									
50	DNA 50 (2-Stroke catalyst)	00→	BR9ES	5722			BR9EIX	3981	0.7
	DNA 50 GP	02→	BR9ES	5722			BR9EIX	3981	0.6
	GSM 50 (Gilera 2-Stroke)	00→	BR9ES	5722			BR9EIX	3981	0.7
	H@K 50 (Gilera 2-Stroke)	00→	BR9ES	5722			BR9EIX	3981	0.7
	ICE 50 (Gilera 2-Stroke)	01→	BR9ES	5722			BR9EIX	3981	0.7
	Jetrunner	03→	CPR8E	7411			CR8EIX	4218	0.8
	Pure Jet 50 Direct Injection (2-Stroke)	04→	CPR8E	7411			CR8EIX	4218	0.8
	RCR 50 (2-Stroke Derbi engine)	04→	BR9ES	5722			BR9EIX	3981	0.5
	Runner 50 (2-Stroke)	97→	BR9ES	5722			BR9EIX	3981	0.6
	Runner 50 (4-Stroke)	04→	CPR8E	7411			CR8EIX	4218	0.8
	SKP 50	97→	BR9ES	5722			BR9EIX	3981	0.5
	SMT 50	05→	BR9ES	5722			BR9EIX	3981	0.6
	Stalker 50	03→	BR9ES	5722			BR9EIX	3981	0.5
	Storm 50	09/07→	BR9ES	5722			BR9EIX	3981	0.6
125	125T G1,125GR1		B8ES	2411			BR8EIX	5044	0.5
	Cougar 125	00→03	DPR8EA-9	4929			DPR8EIX-9	2202	0.8
	Crono		B10EG	3630	B10EGV	5927	BR10EIX	6801	0.6
	CX 125 Apache		B10EG	3630	B10EGV	5927	BR10EIX	6801	0.6
	DNA 125 (4-Stroke)	01→	CR9EB	6955			CR9EIX	3521	0.7
	Freestyle (2-Stroke)		B10EG	3630	B10EGV	5927	BR10EIX	6801	0.6
	GFR125				B10EGV	5927	BR10EIX	6801	0.6
	Nexus 125	07→	CR8EB	7784			CR8EIX	4218	0.7
	Runner 125 (4-Stroke)		CR9E	6263			CR9EIX	3521	0.6
	Runner FX125 (2-Stroke)	97→	BR9ES	5722			BR9EIX	3981	0.6
	Runner VX 125 (4-Stroke)	01→	CR9EB	6955			CR9EIX	3521	0.7
	RV 125	86→90	B10EG	3630	B10EGV	5927	BR10EIX	6801	0.6
	SC125 (2-Stroke)	06→	BR8ES	5422			BR8EIX	5044	0.7
	SC125 (4-Stroke Yamaha engine)	07→	BR8ES	5422			BR8EIX	5044	0.7
180	DNA 180 (4-Stroke)	01→	CR9EB	6955			CR9EIX	3521	0.7
	Runner FXR180 (2-Stroke)	98→	BR9ES	5722			BR9EIX	3981	0.6
	Runner VXR 180 (4-Stroke)	01→02	CR9EB	6955			CR9EIX	3521	0.7
200	Runner ST 200	08→	CPR8E	7411			CR8EIX	4218	0.7
	Runner VXR 200 (4-Stroke)	02→08	CPR8E	7411			CR8EIX	4218	0.7
250	Nexus 250 SP	06→	CR8EB	7784			CR8EIX	4218	0.6
300	Nexus 300		CR8EKB	4374			CR8EIX	4218	0.7
350	Dakota 350 (4-Stroke)		DPR8EA-9	4929			DPR8EIX-9	2202	0.6
	Saturno 350 (4-Stroke)	90→	DPR8EA-9	4929			DPR8EIX-9	2202	0.6
460	Nexus 500	04→	CR7EKB	4455			CR7EIX	7385	0.8
500	Dakota 500 (4-Stroke)		DPR8EA-9	4929			DPR8EIX-9	2202	0.6
	Fuoco 500	07→	CR7EKB	4455			CR7EIX	7385	0.8
	Saturno 500 (4-Stroke)	90→93	DPR8EA-9	4929			DPR8EIX-9	2202	0.6



CC	MODEL	DATE	STANDARD COPPER CORE	STOCK NUMBER	PLATINUM OR GOLD PALLADIUM	STOCK NUMBER	IRIDIUM	STOCK NUMBER	GAP MM
GILERA (CONTINUED)									
560	Nordwest 600 (4-Stroke)	91→95	DPR9EA-9	5329			DPR9EIX-9	5545	0.6
	RC600 (4-Stroke)		DPR8EA-9	4929			DPR8EIX-9	2202	0.6
600	Supersport 600	02→	CR9E	6263			CR9EIX	3521	0.6
839	GP800 (Twin Spark)	08→	CR7EKB	4455			CR7EIX	7385	0.8

HARLEY DAVIDSON									
883	XL53C, Sportster 883 (All Models)		DCPR7E	3932	DCPR7EVX	1179	DCPR7EIX	6046	1.0
1000	XL, XLH, XLCH	→78	B-6L	3212					0.7
	XLCR	→79	B-6L	3212					0.7
	XLH, XLS, XLCH	79→	BP6HS	4511			BPR6HIX	4085	1.0
	XR1000	83→85	BPR6ES-11	4824			BPR6EIX-11	3903	1.0
1100	Sportster 1100	86/87	DCPR7E	3932	DCPR7EVX	1179	DCPR7EIX	6046	1.0
1130	VRSC V-Rod, Night Rod, Street Rod	02→	DCPR8E*	4339			DCR8EIX	3606	0.9
1200	FL, FLH, FX, FXE, Super Glide	48→74	BP5S	3011					0.7
	FLH, FLHR, FX, FXE, FXEF, FXS	75→81	BPR5ES-11	4424			BPR5EIX	6597	1.0
	Sportster 1200 (All Models)	88→	DCPR7E	3932	DCPR7EVX	1179	DCPR7EIX	6046	1.0
	XR1200	08→	DCPR9E	2641	DCPR9EVX	6436	DCPR9EIX	2316	0.9
1250	V-Rod Anniversary	11→	DCPR9E	2641	DCPR9EVX	6436	DCPR9EIX	2316	0.6
	VRSC Screamin' Eagle V-Rod	04→	DCPR9E	2641	DCPR9EVX	6436	DCPR9EIX	2316	0.6
1340	All Evolution engines	84→98	BPR5ES-11	4424			BPR5EIX	6597	1.0
	All Shovel Head engines	82→84	ZGR5C	6334					1.0
1450	All 1450cc Models	99→	DCPR7E	3932	DCPR7EVX	1179	DCPR7EIX	6046	1.0
1584	Blackline	11→	DCPR8E*	4339			DCR8EIX	3606	0.9
	FLST Fat Boy	08/06→	DCPR8E*	4339			DCR8EIX	3606	0.9
	Twin Cam 96B Models	06/06→	DCPR8E*	4339			DCR8EIX	3606	0.9

HERO-PUCH									
50	Blinker, Stark, Turbo Sport	94→	BP5ES	6511			BPR5EIX	6597	0.5

HESKETH									
1000	V1000	82→	DR8ES	5423	DR9EVX	6361	DR9EIX	4772	0.7

HONDA									
50	C50		C7HSA	4629			CR7HIX	7544	0.7
	C50C		CR7HS	7223			CR7HIX	7544	0.7
	C50-E Super Cub	84→85	CR7HS	7223			CR7HIX	7544	0.7
	C50L, C50LA-C, C50LA-E	82→88	CR7HS	7223			CR7HIX	7544	0.7
	C50ZZ, C50ZZ		CR7HS	7223			CR7HIX	7544	0.7
	CB50J		CR6HS	7023			CR6HIX	7274	0.7
	CR50R-E/F/G		BR9ES	5722			BR9EIX	3981	0.7
	CRF50F	04→	CR6HSA	2983			CR6HIX	7274	0.6
	MB50A-B		BR7HS	4122			BR7HIX	7067	0.7
	MBX50S-D	83→86	BR6ES	4922					0.7
	Melody, Mini Melody, Vision		BPR6HSA	4632			BPR6HIX	4085	0.7
	MT50A-B, MT50S-L	80→93	BR7HS	4122			BR7HIX	7067	0.7
	MTX50S-C	82→85	BR7HS	4122			BR7HIX	7067	0.7
	NC50		BPR6HSA	4632			BPR6HIX	4085	0.7
	ND50M-C		BPR4HS	7823					0.7
	NE50	85→90	BPR6HSA	4632			BPR6HIX	4085	0.7
	NS50MS	81→85	BPR6HSA	4632			BPR6HIX	4085	0.7
	NSC50 Vision	12→	CR7HSA-9	5147			CR7HIX	7544	0.9
	NSC50R	13→	CR7HSA-9	5147			CR7HIX	7544	0.9
	NT50-H	87→94	BPR6HSA	4632			BPR6HIX	4085	0.7
	NU50M-C		BPR5HS	6222					0.7
	NV50MS-D	82→87	BPR5HS	6222					0.7
	NX50M		BPR5HS	6222					0.7



* Please note DCPR8E 4339 has a removable terminal nut, whereas DCPR8E 4179 has a fixed terminal nut





CC	MODEL	DATE	STANDARD COPPER CORE	STOCK NUMBER	PLATINUM OR GOLD PALLADIUM	STOCK NUMBER	IRIDIUM	STOCK NUMBER	GAP MM
HONDA (CONTINUED)									
50	PA50VC	86→91	BPR6HS	7022			BPR6HIX	4085	0.7
	PC50 (OHC)	→69	C6HSA	3228			CR6HIX	7274	0.6
	PC50K (OHV)	70→	C7HSA	4629			CR7HIX	7544	0.6
	PF50MR2		B6HS	4510			BR6HIX	3419	0.7
	PX50	81→86	BPR5HS	6222					0.7
	PXR50	85→87	BPR4HS	7823					0.7
	QR50-D, QR50-F/R		BPR4HS	7823					0.7
	SA50-J, SA50M/N/P	88→95	BPR6HSA	4632			BPR6HIX	4085	0.7
	SFX50S-T-V-W-X-Y	95→03	BR6HSA	4296			BPR6HIX	4085	0.6
	SGX50-V-W-X-Y (Sky)	97→	BR6HSA	4296			BPR6HIX	4085	0.6
	SH50E-S	84→96	BPR6HS	7022			BPR6HIX	4085	0.7
	SH50T-X-Y Bali	96→03	BR6HSA	4296			BPR6HIX	4085	0.6
	SJ50-P-R-S-V-W	93→99	BR6HSA	4296			BPR6HIX	4085	0.6
	SRX50 Shadow	2003	BR6HSA	4296			BPR6HIX	4085	0.6
	SS50	67→	C6HSA	3228			CR6HIX	7274	0.6
	ST50J DAX, ST50J/K	88→93	CR6HSA	2983			CR6HIX	7274	0.7
	SZX-50 (X8R-S, X8R-X)		BR6HSA	4296			BPR6HIX	4085	0.6
	TLM50		B8ES	2411			BR8EIX	5044	0.7
	X8R S/X	98→03	BR6HSA	4296			BPR6HIX	4085	0.6
	XR50	96→02	CR6HSA	2983			CR6HIX	7274	0.7
	XR50R	03→	CR6HSA	2983			CR6HIX	7274	0.7
XR50 Motard	05→	CR6HSA	2983			CR6HIX	7274	0.9	
Z50R-D		CR6HS	7023			CR6HIX	7274	0.7	
Zoomer	06→	ER8EH-N	5606					0.7	
60	CR60R-G		BR9ES	5722			BR9EIX	3981	0.7
70	C70C/E	82→86	CR7HS	7223			CR7HIX	7544	0.7
	CRF70F	04→	CR6HSA	2983			CR6HIX	7274	0.6
	CZ70ZZ, CZ70Z2, C70/C, CF70/C		CR7HS	7223			CR7HIX	7544	0.7
	XR70V, XR70R		CR6HSA	2983			CR6HIX	7274	0.6
80	CR80R-D/E/F/2F/G/2G		BR9ES	5722			BR9EIX	3981	0.7
	CR80R, CR80R2	02→	BR10EG	3830			BR10EIX	6801	0.5
	CR80RB		B9EG	3530	B9EGV	5827	BR9EIX	3981	0.7
	CR80RH-RS/T/V		BR10EG	3830			BR10EIX	6801	0.5
	MBX80FWD-D	83→86	BR9ES	5722			BR9EIX	3981	0.7
	MTX80R-E	83→86	BR8ES	5422			BR8EIX	5044	0.7
	NH80MD/H-P	82→96	BPR6HS	7022			BPR6HIX	4085	0.7
	XR80R-J		CR7HS	7223			CR7HIX	7544	0.7
85	CR85R/R2	03→06	BR10EG	3830			BR10EIX	6801	0.5
90	C90 ZZ (Step Thru)	79→83	D6HA	6512					0.7
	C90E-C/E/G, C90MF-T (Step Thru)	84→96	CR7HS	7223			CR7HIX	7544	0.7
	C90MT (Step Thru)	96→03	CR6HSA	2983			CR6HIX	7274	0.6
	CM90, CM91		D6HA	6512					0.7
	EZ90-M		BR7HS	4122			BR7HIX	7067	0.7
	S90		D6HA	6512					0.7
	SXR90 Joker	01→	BR6HSA	4296			BPR6HIX	4085	0.6
100	CB100 (N/NA/NB)	78→86	DR8ES-L	2923	DR8EVX	6354	DR8EIX	6681	0.7
	CRF100F	04→	CR7HSA	4549			CR7HIX	7544	0.6
	H100A/B/S2G	80→92	BR7HS	4122			BR7HIX	7067	0.7
	H100SE/J		BR8HS	4322			BR8HIX	7001	0.7
	SCV100 Lead	03→	CR6HSA	2983			CR6HIX	7274	0.6
	SJ100T-V-W (Bali)	97→99	BR6HSA	4296			BPR6HIX	4085	0.6
	XR100 Motard	05→	CR7HSA	4549			CR7HIX	7544	0.9
	XR100R		CR7HSA	4549			CR7HIX	7544	0.6
108	NHX110 Lead (Fi)	08→	CR8EH-9	5666			CR8EHIX-9	3797	0.9
	NSC110 Vision	11→	CPR8EA-9	2306			CR8EIX	4218	0.9
109	AFS110 Wave 110i	12→	CPR6EA-9S	1582					0.9
	CRF110F	12→13	CPR6EA-9S	1582					0.9
125	ANF125 Innova	03→	CPR6EA-9	6899					0.9
	ANF125i Innova	07→	CPR6EA-9	6899					0.9
	CA125S	95→99	CR6HSA	2983			CR6HIX	7274	0.6
	CB92 Ø10mm Plug	59→64	CR7HS	7223			CR7HIX	7544	0.7
	CB92 Ø12mm Plug	59→64	D8HA	7112					0.7
	CB125 (S/S1/J)		D8EA	2120	DR8EVX	6354	DR8EIX	6681	0.7
	CB125RS-D/E	83→86	DR8ES-L	2923	DR8EVX	6354	DR8EIX	6681	0.7
	CB125T (2/B/D-C/D/D-E)	82→88	CR8HS	7423	CR8HVX	7236	CR8HIX	7669	0.7



CC	MODEL	DATE	STANDARD COPPER CORE	STOCK NUMBER	PLATINUM OR GOLD PALLADIUM	STOCK NUMBER	IRIDIUM	STOCK NUMBER	GAP MM
HONDA (CONTINUED)									
125	CBF125	08→	CPR7EA-9	3901					0.9
	CBR125R	04→	CR8E	1275			CR8EIX	4218	0.7
	CC125		D8EA	2120	DR8EVX	6354	DR8EIX	6681	0.7
	CG125 C→T	76→96	DR8ES-L	2923	DR8EVX	6354	DR8EIX	6681	0.7
	CG125 W→	97→	DPR8EA-9	4929			DPR8EIX-9	2202	0.9
	CH125-D/E	83→87	DPR7EA-9	5129			DPR7EIX-9	7803	0.9
	CLR125 City Fly	98→03	DPR8EA-9	4929			DPR8EIX-9	2202	0.8
	CM125/RB		B9EG	3530	B9EGV	5827	BR9EIX	3981	0.5
	CM125C-C	82→86	CR7HS	7223			CR7HIX	7544	0.7
	CR125R D-S/T/V		BR9EG	3230			BR9EIX	3981	0.5
	CRF125F	14→	CPR6EA-9	6899					0.9
	CT125C	82→85	DR8ES-L	2923	DR8EVX	6354	DR8EIX	6681	0.7
	FES 125 Pantheon (2-Stroke)	98→02	BR8ES	5422			BR8EIX	5044	0.6
	FES 125 Pantheon (4-Stroke)	03→	CR8EH-9	5666			CR8EHIX-9	3797	0.9
	MBX125FE/RW-F/H/L		BR8ES	5422			BR8EIX	5044	0.7
	MSX125	13→	CPR6EA-9	6899					0.9
	MTX125R-D/E/F	83→94	BR8ES	5422			BR8EIX	5044	0.7
	NES125 @	00→03	CR8EH-9	5666			CR8EHIX-9	3797	0.9
	NH125MD-D	83→87	BPR6HS	7022			BPR6HIX	4085	0.7
	NS125 F R/S		BR9ECS	3570					0.7
	NS125FG/FH/RK-RP	86→93	BR7ES	5122			BR7EIX	6664	0.7
	NSR125R-R-S-V	90→03	BR9ECS	3570					0.7
	PCX125	10→	CPR7EA-9	3901					0.9
	PS125i (PES125i)	07→	CR8EH-9	5666			CR8EHIX-9	3797	0.9
	SES125 Dylan	02→	CR8EH-9	5666			CR8EHIX-9	3797	0.9
	SH125	01→	CR8EH-9	5666			CR8EHIX-9	3797	0.9
	SH125i	09→12	CR8EH-9	5666			CR8EHIX-9	3797	0.9
	SH125i	13→	CPR7EA-9	3901					0.9
	SS125	67→69	D8HA	7112					0.7
	S-Wing 125	07→	CR8EH-9	5666			CR8EHIX-9	3797	0.9
	VT125 /C2 Shadow	98→	CR8EH-9	5666			CR8EHIX-9	3797	0.8
	XL125 (S/SA/SB/RO/RF)	75→87	DR8ES-L	2923	DR8EVX	6354	DR8EIX	6681	0.7
	XL125V Varadero	01→	CR8EH-9	5666			CR8EHIX-9	3797	0.9
	XLR125R	97→99	DPR8EA-9	4929			DPR8EIX-9	2202	0.8
XR125L	03→	DPR8EA-9	4929			DPR8EIX-9	2202	0.8	
150	FES150 Pantheon	05→09	CR8EH-9	5666			CR8EHIX-9	3797	0.9
	CRF150R/R2	07→	CR8EH-9	5666			CR8EHIX-9	3797	0.9
	CRF150R/B	09→	CR8EH-9	5666			CR8EHIX-9	3797	0.9
185	CD185T		CR7HS	7223			CR7HIX	7544	0.7
	XL185S (2/A/B)		DR8ES-L	2923	DR8EVX	6354	DR8EIX	6681	0.7
200	CB200		D8EA	2120	DR8EVX	6354	DR8EIX	6681	0.7
	CD200T (A/B), CM200T (A/B)	80→85	CR7HS	7223			CR7HIX	7544	0.7
	MTX200RW-D	83→86	BR9ES	5722			BR9EIX	3981	0.7
	TLR200R-E/F		DR8ES-L	2923	DR8EVX	6354	DR8EIX	6681	0.7
	XR200 (A/R-C)		DR8ES-L	2923	DR8EVX	6354	DR8EIX	6681	0.7
230	CRF230F	08→	DPR8EA-9	4929			DPR8EIX-9	2202	0.8
250	CB250 K2,K3,K4,G5		B8ES	2411			BR8EIX	5044	0.7
	CB250N A/B/DXB	78→83	DR8ES	5423	DR9EVX	6361	DR9EIX	4772	0.7
	CB250N/T/W	92→	CR6HSA	2983			CR6HIX	7274	0.7
	CB250RS (A/B)	80→83	DR8ES-L	2923	DR8EVX	6354	DR8EIX	6681	0.7
	CB250RSD-C	82→84	DR8ES	5423	DR9EVX	6361	DR9EIX	4772	0.7
	CB250T		DR8ES-L	2923	DR8EVX	6354	DR8EIX	6681	0.7
	CBF250	04→	CR8EH-9S	7750			CR8EHIX-9	3797	0.9
	CBR250R	11→					SIMR8A9	91064	0.9
	CBX250RSE	84→86	DPR8EA-9	4929			DPR8EIX-9	2202	0.9
	CD250U-J/K	88→93	CR6HSA	2983			CR6HIX	7274	0.7
	CH250F/G (Spacy)	85→87	DPR6EA-9	5531					0.9
	CL250S-C	82→84	DR8ES-L	2923	DR8EVX	6354	DR8EIX	6681	0.7
	CM250T	82→84	DR8ES	5423	DR9EVX	6361	DR9EIX	4772	0.7
	CMX250C-T	95→99	CR6HSA	2983			CR6HIX	7274	0.6
	CN250-L/M/N	90→92	DPR6EA-9	5531					0.9
	CR250 R3/R-D/E/F/G/H		BR8EG	3130			BR8EIX	5044	0.5
	CR250R-J		BR9EG	3230			BR9EIX	3981	0.5
	CR250R-S/T/V		BR8EG	3130			BR8EIX	5044	0.5
	CR250R K5	05→	BR9EG-N-8	2689					0.8



CC	MODEL	DATE	STANDARD COPPER CORE	STOCK NUMBER	PLATINUM OR GOLD PALLADIUM	STOCK NUMBER	IRIDIUM	STOCK NUMBER	GAP MM
HONDA (CONTINUED)									
250	CRF250L	12→					SIMR8A9	91064	0.9
	CRF250M	13→					SIMR8A9	91064	0.9
	CRF250R K5/K6 (19mm Thread Reach)	04→09					R0409B-8	7791	0.7
	CRF250R (26.5mm Thread Reach)	10→					R0451B-8	9356	0.7
	CRF250X K5/K6	04→					IMR8C-9H	3653	0.9
	FES250 W-X-Y (Foresight)	97→03	DPR7EA-9	5129			DPR7EIX-9	7803	0.9
	RTL250		D6EA	7512					0.7
	TL250		D7EA	7912					0.7
	TLR250F		DR8ES-L	2923	DR8EVX	6354	DR8EIX	6681	0.7
	VT250F-D	83→87	DPR8EA-9	4929			DPR8EIX-9	2202	0.9
	XL250/K3		D8EA	2120	DR8EVX	6354	DR8EIX	6681	0.7
	XL250R-C	82→84	DR8ES-L	2923	DR8EVX	6354	DR8EIX	6681	0.7
	XL250RE	84→86	DPR9Z	4830					0.7
	XL250S (A/B/Z)	73→82	DR8ES-L	2923	DR8EVX	6354	DR8EIX	6681	0.7
	XR250	→84	D8EA	2120	DR8EVX	6354	DR8EIX	6681	0.7
	XR250RE	84→95	DPR9Z	4830					0.7
	XR250RT/V	96→01	CR9EH-9	7502			CR9EHIX-9	6216	0.9
280	SH300i	07→	LMAR8A-9	4313					0.9
	NSS300 Forza	13→	LMAR8A-9	4313					0.9
350	CB350SG	86→88	DR8ES-L	2923	DR8EVX	6354	DR8EIX	6681	0.7
	XR350R-D		DPR8EA-9	4929			DPR8EIX-9	2202	0.9
	XR350R-E		DPR7EA-9	5129			DPR7EIX-9	7803	0.9
360	CB360G		B8ES	2411			BR8EIX	5044	0.7
400	CB400 (N/NA/NC/T)	78→85	DR8ES	5423	DR9EVX	6361	DR9EIX	4772	0.7
	CB400F1, F2		D8EA	2120	DR8EVX	6354	DR8EIX	6681	0.7
	NS400RF	85→88	BR9ES	5722			BR9EIX	3981	0.7
	VF400F-D	83→86	DPR8EA-9	4929			DPR8EIX-9	2202	0.9
	VFR400 R3-L-P	90→93	ER9EH	5869					0.7
	XR400RT/V		DPR8Z	4730					0.6
450	CB450DX-K	89→92	DR8ES	5423	DR9EVX	6361	DR9EIX	4772	0.7
	CRF450R (19mm Thread Reach)	02→08					IFR8H11	5068	1.1
	CRF450R (26.5mm Thread Reach)	09→					SILMAR9A9S	6213	0.9
	CRF450X	08→					IFR8H11	5068	1.1
480	CR480R-D		B8EG	3430	B8EGV	5627	BR8EIX	5044	0.5
500	CB500F	03/13→	CPR8EA-9	2306			CR8EIX	4218	0.9
	CB500 T	→80	B8ES	2411			BR8EIX	5044	0.7
	CB500-R/T/V/W/X/Y	94→	CR8EH-9	5666			CR8EHIX-9	3797	0.9
	CB500S-W (Half Fairing)	98→	CR8EH-9	5666			CR8EHIX-9	3797	0.9
	CB500X	05/13→	CPR8EA-9	2306			CR8EIX	4218	0.9
	CBF500	04→	CR8EH-9S	7750			CR8EHIX-9	3797	0.9
	CBR500R	03/13→	CPR8EA-9	2306			CR8EIX	4218	0.9
	CR500R-E-S/T/V/W/X	93→	BR8EG	3130			BR8EIX	5044	0.5
	CX500 (Z/A/B/CA/DA/CB/EC)	78→84	DR8ES-L	2923	DR8EVX	6354	DR8EIX	6681	0.7
	CX500 TURBO	82→84					DPR8EIX-9	2202	0.9
	FT500-C	82→84	DR8ES	5423	DR9EVX	6361	DR9EIX	4772	0.7
	GL500 Silverwing	82→84	DR8ES-L	2923	DR8EVX	6354	DR8EIX	6681	0.6
	VF500F 2E/2F	84→87	DPR8EA-9	4929			DPR8EIX-9	2202	0.9
	VT500E-D/F	83→88	DPR8EA-9	4929			DPR8EIX-9	2202	0.9
	XBR500F/H/SJ	85→89	DPR8EA-9	4929			DPR8EIX-9	2202	0.9
	XL500 (SA,RC)	79→84	DR8ES-L	2923	DR8EVX	6354	DR8EIX	6681	0.7
	XR500		DR8ES-L	2923	DR8EVX	6354	DR8EIX	6681	0.7
550	CB550		DR7ES	3123					0.7
	CBX550F (C,2-C)	82→86	DR8ES	5423	DR9EVX	6361	DR9EIX	4772	0.7
600	CB600F (Hornet)	98→06	CR9EH-9	7502			CR9EHIX-9	6216	0.9
	CB600F (Hornet)	07→	CR9EH-9	7502			CR9EHIX-9	6216	0.9
	CB600FA (Hornet with ABS)	08→	CR9EH-9	7502			CR9EHIX-9	6216	0.9
	CBF600 N/S (Incl. ABS)	04→07	CR9EH-9	7502			CR9EHIX-9	6216	0.9
	CBF600 N/S (Incl. ABS)	08→	CR8EH-9	5666			CR8EHIX-9	3797	0.9
	CBR600F-H-J	87→88	DPR8EA-9	4929			DPR8EIX-9	2202	0.9
	CBR600F-K-L	89→90	DPR9EA-9	5329			DPR9EIX-9	5545	0.9
	CBR600F-M-N-P-R-S-T-V-W	91→98	CR9EH-9	7502			CR9EHIX-9	6216	0.9
	CBR600F X-Y	99→00	CR9EH-9	7502			CR9EHIX-9	6216	0.9
	CBR600FI / FSI Injection	01→					IMR9A-9H	6966	0.9
	CBR600F Injection	02→					IMR9C-9H	6777	0.9



CC	MODEL	DATE	STANDARD COPPER CORE	STOCK NUMBER	PLATINUM OR GOLD PALLADIUM	STOCK NUMBER	IRIDIUM	STOCK NUMBER	GAP MM
HONDA (CONTINUED)									
600	CBR600F Sport	02→					IMR9C-9H	6777	0.9
	CBR600F	03/11→	CR9EH-9	7502			CR9EHIX-9	6216	0.9
	CBR600RR	03/03→08					IMR9C-9HES	5766	0.9
	CBR600RR (Incl. ABS)	09→					IMR9E-9HES	7556	0.9
	FJS600 Silverwing (Incl. ABS)	01→	CR8EH-9	5666			CR8EHIX-9	3797	0.9
	NTV600K/M Revere	88→93	DPR8EA-9	4929			DPR8EIX-9	2202	0.9
	VT600C-N-P-R-S-T-V-W	92→01	DPR8EA-9	4929			DPR8EIX-9	2202	0.9
	XL600LM-F	84→86	DPR8EA-9	4929			DPR8EIX-9	2202	0.9
	XL600RD-E	84→86	DPR8EA-9	4929			DPR8EIX-9	2202	0.9
	XL600VH-VX (Transalp)	87→00	DPR8EA-9	4929			DPR8EIX-9	2202	0.9
	XR600R-V		DPR8EA-9	4929			DPR8EIX-9	2202	0.8
650	CB650 Z, 2, B	78→82	DR8ES-L	2923	DR8EVX	6354	DR8EIX	6681	0.7
	CB650 SC-C (Nighthawk)	82→84	DR8ES-L	2923	DR8EVX	6354	DR8EIX	6681	0.7
	CX650E-D	83→86	DPR8EA-9	4929			DPR8EIX-9	2202	0.9
	CX650TC-D	83→85	DPR8EA-9	4929			DPR8EIX-9	2202	0.9
	FMX650	05→08	DPR8EA-9	4929			DPR8EIX-9	2202	0.9
	FX650 Vigor	99→03	DPR8EA-9	4929			DPR8EIX-9	2202	0.9
	NT650V-W-X-Y (Deauville)	98→05	DPR8EA-9	4929			DPR8EIX-9	2202	0.9
	NTV650P-T/V	92→97	DPR8EA-9	4929			DPR8EIX-9	2202	0.9
	NX650K-T-V-W-X Dominator	88→03	DPR8EA-9	4929			DPR8EIX-9	2202	0.9
	SLR650	96→99	DPR8EA-9	4929			DPR8EIX-9	2202	0.8
	XL650 /-V (Transalp)	00→07	DPR8EA-9	4929			DPR8EIX-9	2202	0.9
XR650R, R-2		BKR7E-11	1283					1.0	
670	NC700D Integra	12→					IFR6G-11K	1314	1.1
	NC700S/X	12→					IFR6G-11K	1314	1.1
680	DN-01	08→					SIMR8A9	91064	0.9
	NT700V Deauville (Incl. ABS)	06→	CPR8EA-9	2306			CR8EIX	4218	0.9
	XL700V Transalp (Incl. ABS)	08→	CPR8EA-9	2306			CR8EIX	4218	0.9
750	CB750 (SOHC)	70→78	D8EA	2120	DR8EVX	6354	DR8EIX	6681	0.7
	CB750 (DOHC)	79→84	DR8ES	5423	DR9EVX	6361	DR9EIX	4772	0.7
	CB Seven Fifty	92→02	DPR8EA-9	4929			DPR8EIX-9	2202	0.9
	CBX750FE	84→86	DPR8EA-9	4929			DPR8EIX-9	2202	0.9
	NR (750)	1992	ER9EH	5869					0.7
	RVF750R-S (RC45)	94→98					CR9EHIX-9	6216	0.9
	VF750 (C/F/S)		DPR8EA-9	4929			DPR8EIX-9	2202	0.9
	VF750CP-S		CR8EH-9	5666			CR8EHIX-9	3797	0.9
	VFR750F G-F-K	86→88	DPR9EA-9	5329			DPR9EIX-9	5545	0.9
	VFR750F L-T-V	89→97	CR8EH-9	5666			CR8EHIX-9	3797	0.9
	VFR750R-K/L (RC30)	88→92	CR9EH-9	7502			CR9EHIX-9	6216	0.9
	VT750C2 VT750 V/W Shadow	97→	DPR8EA-9	4929			DPR8EIX-9	2202	0.8
	VT750DC Shadow	01→	DPR8EA-9	4929			DPR8EIX-9	2202	0.8
	VT750C NEC Shadow Spirit	07→	DPR7EA-9	5129			DPR7EIX-9	7803	0.9
	VT750DC Shadow Spirit	07→	DPR7EA-9	5129			DPR7EIX-9	7803	0.9
	VT750C Shadow Black Spirit	10→	DPR7EA-9	5129			DPR7EIX-9	7803	0.9
VT750S	10→	DPR7EA-9	5129			DPR7EIX-9	7803	0.9	
XRV750L-V-W-X-Y (Africa Twin)	90→03	DPR8EA-9	4929			DPR8EIX-9	2202	0.9	
800	VFR800F-W Fi X-Y (781cc)	97→01	CR9EH-9	7502			CR9EHIX-9	6216	0.8
	VFR800F-W K2→ Fi VTEC (Incl. ABS) (782cc)	02→					IMR9B-9H	4888	0.9
	VFR800X Crossrunner (782cc)	05/11→					IMR9D-9H	6544	0.9
900	CB900F/F2 (Z, D, 2-D)	79→85	DR8ES	5423	DR9EVX	6361	DR9EIX	4772	0.7
	CB900F Hornet	02→08	CR8EH-9	5666			CR8EHIX-9	3797	0.9
	CBR900RR-N-S Fireblade (893cc)	92→95	CR9EH-9	7502			CR9EHIX-9	6216	0.9
	CBR900RR-T-V-W-X Fireblade (918cc)	96→99	CR9EH-9	7502			CR9EHIX-9	6216	0.9
	CBR900RR Y Fireblade (929cc Injection Model)	00→01					CR9EHI-9	6419	0.9
	CBR900RR K2 Fireblade (954cc '02 model)	02→03					IMR9C-9H	6777	0.9
1000	CB1000F-V		DPR9EA-9	5329			DPR9EIX-9	5545	0.9
	CB1000R/RA	08→					IMR9E-9HES	7556	0.9
	CBF1000 (Incl. ABS)	06→10	CR8EH-9	5666			CR8EHIX-9	3797	0.9
	CBF1000A (Incl. ABS)	10→					IMR8C-9HES	5990	0.9
	CBF1000F (Incl. ABS)	10→					IMR8C-9HES	5990	0.9
	CBR1000FH-FX	87→99	DPR9EA-9	5329			DPR9EIX-9	5545	0.9
	CBR1000RR Fireblade	04→07					IMR9C-9HES	5766	0.9
	CBR1000RR Fireblade (Incl. ABS)	08→					IMR9E-9HES	7556	0.9
	GL1000 (Gold Wing)	75→	DR8ES-L	2923	DR8EVX	6354	DR8EIX	6681	0.7



CC	MODEL	DATE	STANDARD COPPER CORE	STOCK NUMBER	PLATINUM OR GOLD PALLADIUM	STOCK NUMBER	IRIDIUM	STOCK NUMBER	GAP MM
HONDA (CONTINUED)									
1000	VF1000F2F Bol d'Or		DPR9EA-9	5329			DPR9EIX-9	5545	0.9
	VF1000FE	84→85	DPR8EA-9	4929			DPR8EIX-9	2202	0.9
	VF1000FF	85→87	DPR9EA-9	5329			DPR9EIX-9	5545	0.9
	VF1000RE-High Speed		DPR9EA-9	5329			DPR9EIX-9	5545	0.9
	VF1000RE-Standard		DPR8EA-9	4929			DPR8EIX-9	2202	0.9
	VF1000RF	85→88	DPR9EA-9	5329			DPR9EIX-9	5545	0.9
	VTR1000 F W-Y (Firestorm)	97→08					DPR9EIX-9	5545	0.9
	VTR1000 SP1	00→01					FR9BI-11	4709	1.1
	VTR1000 SP2	02→					IFR9H11	6588	1.1
	XL1000V-Y (Varadero)	98→02					DPR8EIX-9	2202	0.8
XL1000V Varadero (Incl. ABS)	03→					IJR8B9	4873	0.9	
1050	CBX1000B,C (6-cyl.)	78→84	DR8ES-L	2923	DR8EVX	6354	DR8EIX	6681	0.7
1100	CB1100 (RB,RC,RD) Road Use	82→84	DR8ES	5423	DR9EVX	6361	DR9EIX	4772	0.7
	CB1100SF-Y (X11)	99→					CR8EHIX-9	3797	0.9
	CBR1100 XX V-Y (Super Blackbird)	96→					CR9EHIX-9	6216	0.9
	CBR1100 XX K1 (Super Blackbird)	2001					IMR9A-9H	6966	0.9
	CBR1100 XX K2 (Super Blackbird) 3405930→	02→					IMR9C-9H	6777	0.9
	GL1100B (Gold Wing)	80→	DR8ES-L	2923	DR8EVX	6354	DR8EIX	6681	0.7
	ST1100 ABS/TCS/T/V	95→	CR8EH-9	5666			CR8EHIX-9	3797	0.9
ST1100/L S-Y (Pan European)	89→03	CR8EH-9	5666			CR8EHIX-9	3797	0.9	
1140	CB1100	13→	LMAR8A-9S	6817					0.9
1200	GL1200-EDE/IE/AE/AF/AH (Gold Wing)	84→88	DPR7EA-9	5129			DPR7EIX-9	7803	0.9
1237	VFR1200F/FD	10→					IMR9E-9HES	7556	0.9
	VFR1200X Crosstourer	04/12→					IMR8E-9HES	95397	0.9
1260	ST1300 Pan European (Incl. ABS)	02→	CR7EH-9	3486			CR7EIX	7385	0.9
1300	CB1300 (Incl. ABS)	03→	DPR8EA-9	4929			DPR8EIX-9	2202	0.9
	CB1300S (Incl. ABS)	05→	DPR8EA-9	4929			DPR8EIX-9	2202	0.9
	VTX1300, VT1300CX	03→	DCPR6E	3481					0.9
1500	GL1500 J-L, GL1500 SE M-Y (Gold Wing)	88→01	DPR6EA-9	5531					0.9
	GL1500CT (Gold Wing)	97→00	DPR7EA-9	5129			DPR7EIX-9	7803	0.9
	GL1500C-V-W-(F6C) (Gold Wing)	96→03	DPR7EA-9	5129			DPR7EIX-9	7803	0.9
1800	GL1800 (Gold Wing) (Incl. ABS)	01→	BKR6E-11	2756			BKR6EIX-11	3764	1.1
	VTX1800/C	01→08					IFR6L11	3678	1.1

HUONIAO									
50	HN50-QT8	07→	C7HSA	4629			CR7HIX	7544	0.7
125	HN125-8	06→	D8EA	2120			DR8EIX	6681	0.7

HUSABERG									
250	FE250	13→	CR9EKB	2305			CR9EIX	3521	0.8
	TE250	11→	BR7ES	5122			BR7EIX	6664	0.7
300	TE300	11→	BR7ES	5122			BR7EIX	6664	0.7
390	FE 390	10→					LKAR8AI-9	6706	0.9
400	FE, FS 400E/C	00→	DCPR8E*	4179			DCR8EIX	3606	0.6
450	FE 450	09→					LKAR8AI-9	6706	0.9
470	FC, FX 470/6, E	00→	DCPR8E*	4179			DCR8EIX	3606	0.6
550	FC 550/4/6	00→	DCPR8E*	4179			DCR8EIX	3606	0.6
565	FE 570	09→					LKAR8AI-9	6706	0.9
	FS 570	10→					LKAR8AI-9	6706	0.9
650	FE, FS, FX 650 Supermoto	00→	DCPR8E*	4179			DCR8EIX	3606	0.6

HUSQVARNA									
50	CR50	11→	BR8ECM	3035	BR8ECMVX	5567			0.7
	Husky Boy Basic	00→04	B8HS	5510	B8HVX	2634	BR8HIX	7001	0.5
	Husky Boy Junior (12.7mm Thread Reach)	99→02	B6HS	4510			BR6HIX	3419	0.5
	Husky Boy Junior (19mm Thread Reach)	03→			B10EGV	5927	BR10EIX	6801	0.6
	Husky Boy Racing	01→	B6HS	4510			BR6HIX	3419	0.5
	Husky Boy Senior (12.7mm Thread Reach)	99→02	B6HS	4510			BR6HIX	3419	0.5



* Please note DCPR8E 4339 has a removable terminal nut, whereas DCPR8E 4179 has a fixed terminal nut





CC	MODEL	DATE	STANDARD COPPER CORE	STOCK NUMBER	PLATINUM OR GOLD PALLADIUM	STOCK NUMBER	IRIDIUM	STOCK NUMBER	GAP MM
HUSQVARNA (CONTINUED)									
50	Husky Boy Senior (19mm Thread Reach)	03→			B10EGV	5927	BR10EIX	6801	0.6
	SM50	02→10	BR9ES	5722			BR9EIX	3981	0.7
	SM50	11→	BR8ECM	3035	BR8ECMVX	5567			0.7
	WRS 50 (Scooter)		B9ES	2611	B9EVX	7254	BR9EIX	3981	0.7
	WSM 50	03→	BR9ES	5722			BR9EIX	3981	0.7
	WXE 50	03→	BR9ES	5722			BR9EIX	3981	0.7
65	CR65	06/11→	BR8ECM	3035	BR8ECMVX	5567			0.6
125	CR125	→91	B9EG	3530	B9EGV	5827	BR9EIX	3981	0.5
	CR125	92→01			B95EGV	2145			0.5
	CR125	02→05	BR9EG	3230			BR9EIX	3981	0.5
	CR125	10→	BR9EG	3230			BR9EIX	3981	0.6
	SM125 /S	98→	BR9EG	3230			BR9EIX	3981	0.5
	SMS4 125	11→	CR8E	1275			CR8EIX	4218	0.7
	TE125	11→	CR8E	1275			CR8EIX	4218	0.7
	WR125	→91	B9EG	3530	B9EGV	5827	BR9EIX	3981	0.5
	WR125	92→			B95EGV	2145			0.5
	WR125	02→	BR9EG	3230			BR9EIX	3981	0.5
	WRE125	94→97	B10EG	3630	B10EGV	5927	BR10EIX	6801	0.5
	WRE125 (Restricted)	98→	BR9EG	3230			BR9EIX	3981	0.5
	WRE125 (Restricted)	09→	BR9EG	3230			BR9EIX	3981	0.6
	WRK125	→89			B10EGV	5927	BR10EIX	6801	0.5
	WSM125	04→	CR7HSA	4549			CR7HIX	7544	0.7
WXE125	04→	CR7HSA	4549			CR7HIX	7544	0.7	
240	WR240		B8EG	3430	B8EGV	5627	BR8EIX	5044	0.5
250	CR250	92→00			B95EGV	2145			0.5
	CR250	01→04	B8EG	3430	B8EGV	5627	BR8EIX	5044	0.5
	CR250	04→	BR8EG	3130			BR8EIX	5044	0.6
	TC250	02→05	CR8EB	7784			CR8EIX	4218	0.7
	TC250	10→	CR9EB	6955			CR9EIX	3521	0.7
	TE250	02→	CR8EB	7784			CR8EIX	4218	0.7
	TE250 i.e	10→	CR9EB	6955			CR9EIX	3521	0.7
	TXC250	10→	CR9EB	6955			CR9EIX	3521	0.7
	WR250	92→01			B9EGV	5827	BR9EIX	3981	0.5
	WR250	02→	BR8EG	3130			BR8EIX	5044	0.6
WRK250	→89			B10EGV	5927	BR10EIX	6801	0.5	
260	WRK260	→89			B10EGV	5927	BR10EIX	6801	0.5
300	WR300	09→	BR8EG	3130			BR8EIX	5044	0.6
302	TE310	09→10	CR8EB	7784			CR8EIX	4218	0.7
	TE310	11→	CR9EB	6955			CR9EIX	3521	0.7
350	TE350	90→95	C8E	7471			CR8EIX	4218	0.5
	WR350	92→02			B9EGV	5827	BR9EIX	3981	0.5
360	CR360	92→94			B8EGV	5627	BR8EIX	5044	0.5
	WR360	02→	B8EG	3430	B8EGV	5627	BR8EIX	5044	0.5
390	CR390		B8EG	3430	B8EGV	5627	BR8EIX	5044	0.5
400	SM400	02→05	CR8EB	7784			CR8EIX	4218	0.7
	TE400	01→	CR8EB	7784			CR8EIX	4218	0.7
	WR400		B8EG	3430	B8EGV	5627	BR8EIX	5044	0.5
410	TE410	96→00	C8E	7471			CR8EIX	4218	0.5
	TE410e	99→00	CR7E	4578			CR7EIX	7385	0.6
430	CR430		B8EG	3430	B8EGV	5627	BR8EIX	5044	0.5
	WR430		B8EG	3430	B8EGV	5627	BR8EIX	5044	0.5
435	CR435		B8EG	3430	B8EGV	5627	BR8EIX	5044	0.5
450	SM450R	03→07	CR8EB	7784			CR8EIX	4218	0.7
	SM450RR	08→	CR9EKB	2305			CR9EIX	3521	0.8
	TC449	11→	CR9EKB	2305			CR9EIX	3521	0.8
	TC450	04→	CR8EB	7784			CR8EIX	4218	0.7
	TE449	11→	CR9EKB	2305			CR9EIX	3521	0.8
	TE450	03→	CR8EB	7784			CR8EIX	4218	0.7
478	SMR511	11→	CR9EKB	2305			CR9EIX	3521	0.8
	TE511	11→	CR9EKB	2305			CR9EIX	3521	0.8
500	CR500		B8EG	3430	B8EGV	5627	BR8EIX	5044	0.5
	WR500		B8EG	3430	B8EGV	5627	BR8EIX	5044	0.5
	TC500 (Air Cooled)	→5/86	D8EA	2120	DR8EVX	6354	DR8EIX	6681	0.5



CC	MODEL	DATE	STANDARD COPPER CORE	STOCK NUMBER	PLATINUM OR GOLD PALLADIUM	STOCK NUMBER	IRIDIUM	STOCK NUMBER	GAP MM
HUSQVARNA (CONTINUED)									
510	SM510 R i.e	10→	CR8EB	7784			CR8EIX	4218	0.7
	TC510 (Liquid Cooled)	06/86→90	C7E	5096			CR7EIX	7385	0.5
	TE510 (Air Cooled)	→5/86	D8EA	2120	DR8EVX	6354	DR8EIX	6681	0.5
	TE510 (Liquid Cooled)	06/86→90	C7E	5096			CR7EIX	7385	0.6
	TE510	04→	CR8EB	7784			CR8EIX	4218	0.7
530	SM530RR	09→	CR9EKB	2305			CR9EIX	3521	0.8
570	SM570	01→04	CR7EB	4663			CR7EIX	7385	0.6
	SM570R	02→04	C7E	5096			CR7EIX	7385	0.6
	SM570R 2004 (Competition Plug)	04→	C8E	7471			CR8EIX	4218	0.5
	TC570	01→02	CR7EB	4663			CR7EIX	7385	0.6
	TE570	01→03	CR7EB	4663			CR7EIX	7385	0.6
600	SMS630 i.e	11→	CR8EB	7784			CR8EIX	4218	0.7
	TE630 i.e	11→	CR8EB	7784			CR8EIX	4218	0.7
610	SM610 S (Std. Plug)	98→05	CR7E	4578			CR7EIX	7385	0.6
	SM610 S (Competition Plug)	03→	C8E	7471			CR8EIX	4218	0.5
	SM610	06→	CPR8E	7411			CR8EIX	4218	0.8
	TC610	91→00	C7E	5096			CR7EIX	7385	0.5
	TE610	91→00	C8E	7471			CR8EIX	4218	0.5
	TE610e	98→05	CR7E	4578			CR7EIX	7385	0.6
630	SMR630	04→	R0045J-10	7400					1.1
650	TR650 Strada (Twin Spark)	10/12→	MAR9A-J	6869					0.8
	TR650 Terra (Twin Spark)	10/12→	MAR9A-J	6869					0.8
900	Nuda 900, 900R	12→	LMAR8C-9	93833					0.9

HYMOTO									
50	HY50		C7HSA	4629			CR7HIX	7544	0.7
	MP DB701 2-Stroke		BPM7A	7321					0.7
70	HY70		C7HSA	4629			CR7HIX	7544	0.7
90	HY90		C7HSA	4629			CR7HIX	7544	0.7
110	HY110		C7HSA	4629			CR7HIX	7544	0.7
125	HY125		C7HSA	4629			CR7HIX	7544	0.7
	HY125S		C7HSA	4629			CR7HIX	7544	0.7

HYOSUNG									
50	SD50, Sense50	99→05	BP6HS	4511			BPR6HIX	4085	0.7
	SF50	99→05	BR8HSA	5539			BPR8HIX	6742	0.7
100	EZ100	99→	BP7HS	5111			BPR7HIX	5944	0.7
110	FX110		C6HSA	3228			CR6HIX	7274	0.7
	Midas DLX 110	99→	C6HSA	3228			CR6HIX	7274	0.7
125	Cruise 1 125	96→	D8EA	2120	DR8EVX	6354	DR8EIX	6681	0.7
	Cruise 2 125	99→	CR8EH-9	5666			CR8EHIX-9	3797	0.9
	GA125 Cruise III	00→	CR8EH-9	5666			CR8EHIX-9	3797	0.9
	GF125	99→	CR8EH-9	5666			CR8EHIX-9	3797	0.9
	Grand Prix 125, GP-Plus	99→	DR8EA	7162	DR8EVX	6354	DR8EIX	6681	0.7
	GT125	03→	CR8E	1275			CR8EIX	4218	0.6
	GT125R	06→	CR8E	1275			CR8EIX	4218	0.6
	GV125 Aquila	00→	CR8E	1275			CR8EIX	4218	0.6
	GV125C	08→	CR8E	1275			CR8EIX	4218	0.8
	HD125 Hyper	04→06	DR8EA	7162	DR8EVX	6354	DR8EIX	6681	0.8
	MS3-125	07→	CR8E	1275			CR8EIX	4218	0.8
	RT125 (SOHC engine)	04→07	CR8EH-9	5666			CR8EHIX-9	3797	0.9
	RT125D (DOHC engine)	07→	CR8E	1275			CR8EIX	4218	0.8
	RX125 (SOHC engine)	00→07	CR8EH-9	5666			CR8EHIX-9	3797	0.9
	RX125D-E (DOHC engine)	07→	CR8E	1275			CR8EIX	4218	0.8
RX125D SM (DOHC engine)	07→	CR8E	1275			CR8EIX	4218	0.8	
XRX125 (SOHC engine)	→07	CR8EH-9	5666			CR8EHIX-9	3797	0.8	
250	GT250, Comet	03→	CR8E	1275			CR8EIX	4218	0.8
	GT250 EFI, Comet	08→	CR8E	1275			CR8EIX	4218	0.8
	GT250R	06→08	CR8E	1275			CR8EIX	4218	0.8
	GT250R EFI	08→	CR8E	1275			CR8EIX	4218	0.8
	GV250, Aquila	00→	CR8E	1275			CR8EIX	4218	0.8

2 Wheel



CC	MODEL	DATE	STANDARD COPPER CORE	STOCK NUMBER	PLATINUM OR GOLD PALLADIUM	STOCK NUMBER	IRIDIUM	STOCK NUMBER	GAP MM
HYOSUNG (CONTINUED)									
250	GV250 EFI, Aquila	08→	CR8E	1275			CR8EIX	4218	0.8
	MS3-250	07→	CR8E	1275			CR8EIX	4218	0.8
650	GT650, Comet	03→	CR8E	1275			CR8EIX	4218	0.8
	GT650 EFI, Comet	08→	CR8E	1275			CR8EIX	4218	0.8
	GT650N	12→	CR8E	1275			CR8EIX	4218	0.8
	GT650R	06→08	CR8E	1275			CR8EIX	4218	0.8
	GT650R EFI	08→	CR8E	1275			CR8EIX	4218	0.8
	GT650S	06→08	CR8E	1275			CR8EIX	4218	0.8
	GV650, Aquila	06→08	CR8E	1275			CR8EIX	4218	0.8
	GV650 EFI, Aquila	08→	CR8E	1275			CR8EIX	4218	0.8
680	GV700C EFI	10→	CR8E	1275			CR8EIX	4218	0.8

INDIAN									
1850	Dakota 4 - Classic, Highway, 4 si (Carb)		BPR6HS	7022			BPR6HIX	4085	0.6
	Dakota 4 - Classic, Highway, 4 si (Injection)		BPR7HS	6422			BPR7HIX	5944	0.6

ITALJET									
50	Dragster D50 LC (Liquid Cooled)	98→04	BR8HS	4322			BR8HIX	7001	0.6
	Formula 50, 50 A, Formula 50 Williams (Air Cooled)	96→04	BPR6HS	7022			BPR6HIX	4085	0.6
	Formula 50 LC	98→04	BR7HS	4122			BR7HIX	7067	0.6
	Jetset 50 2T	01→04	BR9ES	5722			BR9EIX	3981	0.7
	Torpedo 50/T50	97→04	BPR6HS	7022			BPR6HIX	4085	0.6
	Velocifero 50/V50	96→	BPR6HS	7022			BPR6HIX	4085	0.6
100	Millennium 100	00→04	BR7HS	4122			BR7HIX	7067	0.6
125	Dragster D125LC (2-Stroke Liquid Cooled)	99→04	BR9ES	5722			BR9EIX	3981	0.7
	Formula 125 LC (Liquid Cooled)	97→04	BR7HS	4122			BR7HIX	7067	0.6
	Jetset 125 4T	01→04	CR7E	4578			CR7EIX	7385	0.6
	Millennium (4-Stroke Liquid Cooled)	00→04	CR8E	1275			CR8EIX	4218	0.7
	Torpedo T125 4T		CR8E	1275			CR8EIX	4218	0.6
150	Jetset 150 4T	01→04	CR7E	4578			CR7EIX	7385	0.6
	Millennium 150	00→04	CR7E	4578			CR7EIX	7385	0.6
176	Dragster D180LC (2-Stroke Liquid Cooled)	99→04	BR9ES	5722			BR9EIX	3981	0.7
250	Jupiter 250	01→04	DR8EA	7162	DR8EVX	6354	DR8EIX	6681	0.7

JAWA-CZ									
50	Jawa Economy, Jive, Jazz		B6HS	4510			BR6HIX	3419	0.5
	MJ50, Korado Basic/K'start, Lux		B6HS	4510			BR6HIX	3419	0.5
125	CZ125	→84	B8HS	5510	B8HVX	2634	BR8HIX	7001	0.5
	CZ125 Oilmaster	84→	B8HS	5510	B8HVX	2634	BR8HIX	7001	0.5
175	CZ175	→84	B8HS	5510	B8HVX	2634	BR8HIX	7001	0.5
	CZ175	84→	B8HS	5510	B8HVX	2634	BR8HIX	7001	0.5
180	CZ180	84→	B8HS	5510	B8HVX	2634	BR8HIX	7001	0.5
250	CZ250 Single/DeLuxe	→84	B8HS	5510	B8HVX	2634	BR8HIX	7001	0.5
	CZ250	84→	B8HS	5510	B8HVX	2634	BR8HIX	7001	0.5
350	CZ350	→84	B8HS	5510	B8HVX	2634	BR8HIX	7001	0.5
	CZ350 Classic/Style/Sport/Chopper	84→	B8HS	5510	B8HVX	2634	BR8HIX	7001	0.7
500	Jawa 500R	86→90	D8EA	2120	DR8EVX	6354	DR8EIX	6681	0.5

JIALING									
50	CJ50F/K		BPR6HS	7022			BPR6HIX	4085	0.7
	JD 50, JL 50	97→00	BPR6HSA	4632			BPR6HIX	4085	0.6
	JH 50	95→	C7HSA	4629			CR7HIX	7544	0.7
	LX50		BPR6HSA	4632			BPR6HIX	4085	0.7
	QM 50		BPR4HS	7823					0.7
	TA 55		BPR6HSA	4632			BPR6HIX	4085	0.7
70	CJ70		CR7HSA	4549			CR7HIX	7544	0.7
	JD 70, JH 70	94→00	C7HSA	4629			CR7HIX	7544	0.7
90	JH 90	94→96	C6HSA	3228			CR6HIX	7274	0.7
	K 90		BP7HS	5111			BPR7HIX	5944	0.7



CC	MODEL	DATE	STANDARD COPPER CORE	STOCK NUMBER	PLATINUM OR GOLD PALLADIUM	STOCK NUMBER	IRIDIUM	STOCK NUMBER	GAP MM
JIALING (CONTINUED)									
100	K100		BP7HS	5111			BPR7HIX	5944	0.7
	QM100		BP7HS	5111			BPR7HIX	5944	0.7
125	JH125	94→02	DR8ES-L	2923	DR8EVX	6354	DR8EIX	6681	0.7
	Sanyang Duke 125		DPR7EA-9	5129			DPR7EIX-9	7803	0.9
	Sanyang Wolf 125		DR8ES-L	2923	DR8EVX	6354	DR8EIX	6681	0.7

JIANSHE									
125	JS125Y Tiger	03→	DR8ES	5423	DR9EVX	6361	DR9EIX	4772	0.7

JINLUN									
50	JL50QT	04→	CR7HSA	4549			CR7HIX	7544	0.7
125	Hornet 125	08→	CR7HSA	4549			CR7HIX	7544	0.7
	JL125-11/13	06→	CR7HSA	4549			CR7HIX	7544	0.7
	JL125-C/Y	05→	CR7HSA	4549			CR7HIX	7544	0.7
	JL125T	05→	CR7HSA	4549			CR7HIX	7544	0.7
150	JL150	05→	D8EA	2120	DR8EVX	6354	DR8EIX	6681	0.7
250	JL250	06→	CR7HSA	4549			CR7HIX	7544	0.7

JONWAY									
50	Madness 50		C7HSA	4629			CR7HIX	7544	0.7

KAWASAKI									
50	AE50 A1/A2, AR50 A1/C1-C10	81→97	B6ES	7310					0.7
60	KX60 A, B1-B13	83→97	B9EG	3530	B9EGV	5827	BR9EIX	3981	0.7
	KX60 B14-B17	98→01	BR9EG	3230			BR9EIX	3981	0.5
65	KX65 A1-A6	00→05	BR10EG	3830			BR10EIX	6801	0.7
80	AE80 A, AR80 A	81→82	BP8ES	2912	BP8EVX	2671	BPR8EIX	6684	0.7
	AE80 B, AR80 C1-C8	83→93	BPR8ES	3923			BPR8EIX	6684	0.7
	KX80 A, B	79→80	B8EG	3430	B8EGV	5627	BR8EIX	5044	0.5
	KX80 C-R1	81→91	BR9EG	3230			BR9EIX	3981	0.5
	KX80 R2-R7	92→97	R6252K-105	2741					0.7
	KX80 W1, W2	98→99	R6252K-105	2741					0.7
85	KX85 A1-A5/B1-B5	01→05	R6252K-105	2741					0.7
	KX85 A6F/B6F	2006	R6252K-105	2741					0.7
90	KM90A	73→80	B7HS	5110			BR7HIX	7067	0.5
100	G7TA	73→76	B8HS	5510	B8HVX	2634	BR8HIX	7001	0.6
	KC100 C1-C4	79→86	B8ES	2411			BR8EIX	5044	0.7
	KE100 A7-A10, B1-B15	78→99	BR8ES	5422			BR8EIX	5044	0.7
	KH100 A1-A4 (KH100EL)	77→81	B8ES	2411			BR8EIX	5044	0.7
	KH100 G2-G8 (KH100EX)	81→93	B8ES	2411			BR8EIX	5044	0.7
	KM100 A1-A4, A6-A7	76→81	B7HS	5110			BR7HIX	7067	0.6
	KX100 A1-A2, B1	89→91	BR9EG	3230			BR9EIX	3981	0.5
	KX100 B2-B7	92→97	R6252K-105	2741					0.7
	KX100 C1-C3	98→00	R6252K-105	2741					0.7
110	KLX110 A1/A2	02→	CR6HSA	2983			CR6HIX	7274	0.6
	KSR110	03→	CR6HSA	2983			CR6HIX	7274	0.6
125	AR125 A1, A1A, A1B, A2-A7, B1-B8	82→94	BR8ES	5422			BR8EIX	5044	0.7
	BN125 A1-A8 (Eliminator)	98→05	CR7E	4578			CR7EIX	7385	0.7
	BN125 A6F-A7F, A9F (Eliminator)	06→	CR7E	4578			CR7EIX	7385	0.7
	D-Tracker	10→	CR7HSA	4549			CR7HIX	7544	0.7
	KDX125 A1/A2,B1/B2	90→94	BR8ES	5422			BR8EIX	5044	0.7
	KE125 A3-A6	76→79	B8HS	5510	B8HVX	2634	BR8HIX	7001	0.6
	KE125 A7-A8	80→81	B8ES	2411			BR8EIX	5044	0.7
	KE125 A9-A12	82→87	B9ES	2611	B9EVX	7254	BR9EIX	3981	0.7
	KH125 A/L/K/K4/K7-K9	82→99	BR8ES	5422			BR8EIX	5044	0.7
	KLX125	10→	CR7HSA	4549			CR7HIX	7544	0.7
	KMX125 A1-A5/B1-B12	86→02	BR8ES	5422			BR8EIX	5044	0.7
	KX125 A1- A5	74→79	B9EG	3530	B9EGV	5827	BR9EIX	3981	0.6



CC	MODEL	DATE	STANDARD COPPER CORE	STOCK NUMBER	PLATINUM OR GOLD PALLADIUM	STOCK NUMBER	IRIDIUM	STOCK NUMBER	GAP MM
KAWASAKI (CONTINUED)									
125	KX125 A6-A7, B1	80→82					BR9EIX	3981	0.6
	KX125 B2, D-G, H1	83→90	BR10EG	3830			BR10EIX	6801	0.6
	KX125 H2	1991	R6252E-105	2396					0.6
	KX125 J1, J2	92→93	R6252K-105	2741					0.7
	KX125 K1-K5, L1-L4	94→02					BR9EIX	3981	0.6
	KX125 M1	2003					BR9EIX	3981	0.6
	KX125 M2-M3	04→05				R6918B-9	2954		0.8
175	KX125 M6, M7F	06→				BR9ECMVX	2434		0.8
	KDX175 A1-A2	80→81	B9ES	2611	B9EVX	7254	BR9EIX	3981	0.7
	KDX175 A3, B1-B2	82→83					BR9EIX	3981	0.6
	KE175 B1-B3	76→79	B9HS	5810	B9HVX	2254	BR9HIX	5687	0.6
	KE175 D1	1979	B9ES	2611	B9EVX	7254	BR9EIX	3981	0.6
200	KE175 D2-D5	80→84	B7ES	1111			BR7EIX	6664	0.7
	KDX200 E1-E6	89→94	BR9ES	5722			BR9EIX	3981	0.7
	KDX200 H1-H10	95→04	BR8ES	5422			BR8EIX	5044	0.7
	KMX200 A2-A4	88→90	BR8ES	5422			BR8EIX	5044	0.7
	Z200 A1-A4	77→81	B7ES	1111			BR7EIX	6664	0.7
220	Z200 A5-A6	82→88	BR7ES	5122			BR7EIX	6664	0.7
	KDX220 A4-A7	97→00	BR8ES	5422			BR8EIX	5044	0.7
250	KDX220 A8-A12	01→05	BR8ES	5422			BR8EIX	5044	0.7
	A1 (Samurai)	67→71	B8HS	5510	B8HVX	2634	BR8HIX	7001	0.6
	EL250 D4-D5	93→96	CR8HSA	2086	CR8HVX	7236	CR8HIX	7669	0.7
	EL250 F2 (EL252)	97→99	CR8HSA	2086	CR8HVX	7236	CR8HIX	7669	0.7
	ER250 B1-B3 (Z250T)	83→90	DPR9EA-9	5329			DPR9EIX-9	5545	0.9
	EX250 F2-F8 (GPX250), H1-H2 (ZZ-R250)	88→92	CR8HSA	2086	CR8HVX	7236	CR8HIX	7669	0.6
	EX250 F9 (GPX250R)	1995	CR8HSA	2086	CR8HVX	7236	CR8HIX	7669	0.6
	EX250 K8F (Ninja 250R)	08→12	CR8E	1275			CR8EIX	4218	0.7
	F11	72→75	B9HS	5810	B9HVX	2254	BR9HIX	5687	0.6
	KDX250 B2-B4, C1-C3	82→85	BR8ES	5422			BR8EIX	5044	0.7
	KDX250 D1-D5, E1-E2	91→95	BR9ES	5722			BR9EIX	3981	0.7
	KH250 B1-B5	76→82	B9HS	5810	B9HVX	2254	BR9HIX	5687	0.6
	KL250 A1-A4	77→83	B7ES	1111			BR7EIX	6664	0.7
	KL250 C1-C2	83→85	BR8ES	5422			BR8EIX	5044	0.7
	KL250 D2-D11, D16 (KLR250)	85→01	DPR9EA-9	5329			DPR9EIX-9	5545	0.9
	KLX250 B1-B2	81→82	BR7ES	5122			BR7EIX	6664	0.7
	KLX250 D1-D2	93→94	CR8E	1275			CR8EIX	4218	0.7
	KLX250 G1	94→97	CR8E	1275			CR8EIX	4218	0.7
	KLX250 T9F, TAF	09→	CR8E	1275			CR8EIX	4218	0.7
	KR250 C2, C3 (KR1-S)	90→92	BR10ES	4832			BR10EIX	6801	0.7
	KX250 A1-A7, B1	75→82	BR9EG	3230			BR9EIX	3981	0.7
	KX250 C1-C2, D1	83→85	BR8EG	3130			BR8EIX	5044	0.6
	KX250 D2, E1, F1, G1, H1-H2	86→91	BR9EG	3230			BR9EIX	3981	0.7
	KX250 J1-J2	92→93	R6252E-9	4741					0.6
	KX250 K1-K5, L1-L4	94→02					BR8EIX	5044	0.6
	KX250 M1-M2	03→04					BR8EIX	5044	0.6
	KX250 R1, R6F-R7F	05→07				BR8ECMVX	5567		0.6
	KX250 N1-N2 (KX250F 4-Stroke)	04→05	CR8EB	7784			CR8EIX	4218	0.7
	KX250 T6F-XAF (KX250F 4-Stroke)	06→10	CR8E	1275			CR8EIX	4218	0.7
	KX250 YBF Fi (KX250F 4-Stroke)	11→	CPR8EB-9	6607					0.9
	S1 A, B, C (Mach 1)	72→75	B9HS	5810	B9HVX	2254	BR9HIX	5687	0.6
	Z250 A1-A3, B1-B2	79→82	DR8ES	5423	DR9EVX	6361	DR9EIX	4772	0.6
	Z250 C1-C2, G1-G2 (Z50LTD)	80→83	B7ES	1111			BR7EIX	6664	0.7
300	KLX300 A2-A8, B1-B3	97→03	CR8E	1275			CR8EIX	4218	0.7
	EX300 (Ninja 300)	13→	CR8E	1275			CR8EIX	4218	0.7
305	EX305 A1 (GPz305)	83→84	DPR9EA-9	5329			DPR9EIX-9	5545	0.9
	EX305 B2-B10 (GPz305)	84→96	DPR9EA-9	5329			DPR9EIX-9	5545	0.9
350	A7 (Avenger)	67→71	B9HS	5810	B9HVX	2254	BR9HIX	5687	0.6
	S2, S2A (Mach II)	72→73	B9HS	5810	B9HVX	2254	BR9HIX	5687	0.6
400	KH400 A3-A5	76→78	B8HS	5510	B8HVX	2634	BR8HIX	7001	0.7
	KX400 A	75→76	B9EG	3530	B9EGV	5827	BR9EIX	3981	0.6
	S3, S3A	74→75	B9HS	5810	B9HVX	2254	BR9HIX	5687	0.7
	Z400 D3-D4	76→77	B8ES	2411			BR8EIX	5044	0.7
Z400 B1-B2, G1	78→79	B7ES	1111			BR7EIX	6664	0.7	



CC	MODEL	DATE	STANDARD COPPER CORE	STOCK NUMBER	PLATINUM OR GOLD PALLADIUM	STOCK NUMBER	IRIDIUM	STOCK NUMBER	GAP MM
KAWASAKI (CONTINUED)									
400	Z400 J1-J2	80→81	D8EA	2120	DR8EVX	6354	DR8EIX	6681	0.7
	Z400 J3	82→83	DR8EA	7162	DR8EVX	6354	DR8EIX	6681	0.7
	ZR400 A (A400F)	83→84	DR8ES	5423	DR9EVX	6361	DR9EIX	4772	0.7
	ZR400 B1	84→85	DPR9EA-9	5329			DPR9EIX-9	5545	0.9
	ZX400 C2-C3	85→87	DPR9EA-9	5329			DPR9EIX-9	5545	0.9
	ZX400 L1-L9 (ZXR400)	91→99	CR9EK	4548			CR9EIX	3521	0.7
420	KX420A	80→81	B9EG	3530	B9EGV	5827	BR9EIX	3981	0.6
440	Z440 A2-A3 (LTD), C1-C2	80→82	BR7ES	5122			BR7EIX	6664	0.6
	Z440 H1-H2, D4-D6 (LTD Belt Drive)	82→84	BR7ES	5122			BR7EIX	6664	0.6
450	EN450 A1-A5 (Belt Drive)	85→90	DR8ES	5423	DR9EVX	6361	DR9EIX	4772	0.7
	KLX450 A8F	07→	CPR8EB-9	6607					0.9
	KX450 D6F	06→08	CPR8EB-9	6607					0.9
	KX450F	09→	CPR8EB-9	6607					0.9
500	EN500 A1-A3	90→93	DR8ES	5423	DR9EVX	6361	DR9EIX	4772	0.7
	EN500 B2	94→	DR9EA	3437	DR9EVX	6361	DR9EIX	4772	0.7
	EN500 C1	96→99	DR9EA	3437	DR9EVX	6361	DR9EIX	4772	0.7
	ER500 A1-A4, C3, C4P (ER-5)	97→	DR9EA	3437	DR9EVX	6361	DR9EIX	4772	0.7
	ER500 C5P (ER-5)	06→07	DR9EA	3437	DR9EVX	6361	DR9EIX	4772	0.7
	EX500 A1-A6 (GPz500S)	87→93	DR8ES	5423	DR9EVX	6361	DR9EIX	4772	0.7
	EX500 D1-D3, D5-D7 (GPZ500S)	94→00	DR9EA	3437	DR9EVX	6361	DR9EIX	4772	0.7
	EX500 E10	02→04	DR9EA	3437	DR9EVX	6361	DR9EIX	4772	0.7
	H1 (Mach III), H1A-H1F, KH500A8	69→76	B9HS-10	3626	B9HVX	2254	BR9HIX	5687	1.0
	KLE500 A1-A13	91→03	DR9EA	3437	DR9EVX	6361	DR9EIX	4772	0.7
	KLE500 B6F, B7F	05→	DR9EA	3437	DR9EVX	6361	DR9EIX	4772	0.7
	KX500 A1-A2	83→84	BR9EG	3230			BR9EIX	3981	0.6
	KX500 B, C, D, E1-E16	85→04	BR8EG	3130			BR8EIX	5044	0.5
	Z500 B1-B4	79→82	D8EA	2120	DR8EVX	6354	DR8EIX	6681	0.7
550	Z550 A1-A3	80→83	DR8ES	5423	DR9EVX	6361	DR9EIX	4772	0.7
	Z550 C1-C2 (LTD)	81→83	D8EA	2120	DR8EVX	6354	DR8EIX	6681	0.7
	Z550 D1 (GPz550)	81→82	D8EA	2120	DR8EVX	6354	DR8EIX	6681	0.7
	Z550 G1-G9 (GT550)	83→01	DR8ES	5423	DR9EVX	6361	DR9EIX	4772	0.7
	Z550 H1-H2 (GPz550), ZR550 A1 (Z550F)	82→85	DR8ES	5423	DR9EVX	6361	DR9EIX	4772	0.7
	ZR550 B2-B6 (Zephyr 550)	91→98	DR9EA	3437	DR9EVX	6361	DR9EIX	4772	0.6
	ZX550 A2-A4 (GPz550)	85→91	DPR9EA-9	5329			DPR9EIX-9	5545	0.9
600	KL600 A1	84→85	D8EA	2120	DR8EVX	6354	DR8EIX	6681	0.7
	KL600 B1-B2, B4	85→90	DPR8EA-9	4929			DPR8EIX-9	2202	0.9
	ZL600 B1 (Eliminator 600)	95→97	DR9EA	3437	DR9EVX	6361	DR9EIX	4772	0.7
	ZX600 A1-A5 (GPZ600R)	85→90	DR9EA	3437	DR9EVX	6361	DR9EIX	4772	0.7
	ZX600 C1-C7 (GPX600R)	88→96	DR9EA	3437	DR9EVX	6361	DR9EIX	4772	0.7
	ZX600 D1-D3, E1-E12 (ZZ-R600)	90→04	CR9E	6263			CR9EIX	3521	0.7
	ZX600 E6F (ZZR600)	06→	CR9E	6263			CR9EIX	3521	0.7
	ZX600 F1-F3 (Ninja ZX6R)	95→97	CR9E	6263			CR9EIX	3521	0.7
	ZX600 G1-G2 (ZX-6R)	98→99	CR9E	6263			CR9EIX	3521	0.7
	ZX600 J1-J2 (ZX-6R)	00→01	CR9E	6263			CR9EIX	3521	0.7
	ZX600 K1H-N6F (Ninja ZX-6RR)	03→06	CR9E	6263			CR9EIX	3521	0.7
	ZX600 P7F-P8F, R9F-RCF (Ninja ZX-6R)	07→12	CR9E	6263			CR9EIX	3521	0.7
636	ZX636 A1P, B1H-B2H (Ninja ZX-6R)	02→04	CR9E	6263			CR9EIX	3521	0.7
	ZX636 C1H-C6F (Ninja ZX-6R)	05→06	CR9E	6263			CR9EIX	3521	0.7
	ZX636 (Ninja ZX-6R)	13→	CR9E	6263			CR9EIX	3521	0.7
650	EJ650 A1-A2, C1, C5, C6P (W650)	99→05	CR8E	1275			CR8EIX	4218	0.7
	ER650 A7F-C9F (ER-6n)	06→					CR9EIA-9	6289	0.9
	EX650 A7F-A8F, B7F-B8F (ER-6f)	06→					CR9EIA-9	6289	0.9
	KL650 A1-A3	87→90	DPR8EA-9	4929			DPR8EIX-9	2202	0.9
	KL650 B1-B3 (Tengai)	89→92	DPR8EA-9	4929			DPR8EIX-9	2202	0.9
	KL650 C1-C5 (KLR 650)	94→02	DPR8EA-9	4929			DPR8EIX-9	2202	0.9
	KLE650 A7F-CBF (Versys)	07→					CR9EIA-9	6289	0.9
	KLX650 C1-C2	93→96	DPR8EA-9	4929			DPR8EIX-9	2202	0.9
	W650 (EJ650 A1-A2, C1, C5, C6P)	99→05	CR8E	1275			CR8EIX	4218	0.7
	Z650 B1-B3, C2-C3 (Custom)	77→79	B7ES	1111			BR7EIX	6664	0.7
	Z650 D2-D3 (SR)	79→82	B7ES	1111			BR7EIX	6664	0.7
	Z650 F1-F4	82→84	B7ES	1111			BR7EIX	6664	0.7



CC	MODEL	DATE	STANDARD COPPER CORE	STOCK NUMBER	PLATINUM OR GOLD PALLADIUM	STOCK NUMBER	IRIDIUM	STOCK NUMBER	GAP MM
KAWASAKI (CONTINUED)									
750	H2 (Mach IV), H2A, H2B, H2C	72→75	B9HS-10	3626	B9HVX	2254	BR9HIX	5687	1.0
	VN750 A2-A10 (Vulcan)	86→94	DPR7EA-9	5129			DPR7EIX-9	7803	0.9
	Z750 B1-B2	76→77	B8ES	2411			BR8EIX	5044	0.7
	Z750 E1, H1-H2 (LTD), L1-L4	80→85	BR8ES	5422			BR8EIX	5044	0.7
	Z750 P1-P5 (GT750)	82→92	BR8ES	5422			BR8EIX	5044	0.7
	Z750 P7-P9 (GT750)	91→96	DR8ES	5423	DR9EVX	6361	DR9EIX	4772	0.6
	Z750 R1 (GP)	82→83	BR8ES	5422			BR8EIX	5044	0.7
	Z750 Y1 (LTD Twin)	82→83	BPR6ES	7822			BPR6EIX	6637	0.7
	ZR750 C1-C4 (Zephyr 750)	91→94	DR8ES	5423	DR9EVX	6361	DR9EIX	4772	0.6
	ZR750 C5 (Zephyr 750)	1995	DR9EA	3437	DR9EVX	6361	DR9EIX	4772	0.7
	ZR750 D1 (Zephyr 750)	96→99	DR9EA	3437	DR9EVX	6361	DR9EIX	4772	0.7
	ZR750 F1-F5 (ZR-7), H1-H3 (ZR-7S)	05/99→03	DR9EA	3437	DR9EVX	6361	DR9EIX	4772	0.7
	ZR750 J1H (Z750)	04→	CR9EK	4548			CR9EIX	3521	0.7
	ZR750 J6F (Z750)	05→	CR9EK	4548			CR9EIX	3521	0.7
	ZR750 K6F (Z750s)	06→	CR9EK	4548			CR9EIX	3521	0.7
	ZR750 L7F, L8F, M7F, M8F (Z750)	03/07→10	CR9EK	4548			CR9EIX	3521	0.7
	ZR750 N (Z750R)	11→	CR9EK	4548			CR9EIX	3521	0.7
	ZX750 A1-A3, A5 (GPz750)	83→89	BR9ES	5722			BR9EIX	3981	0.7
	ZX750 E1-E2 (Turbo)	83→87					BR9EIX	3981	0.6
	ZX750 F1-F5 (GPX750R)	87→91	DR8ES	5423	DR9EVX	6361	DR9EIX	4772	0.7
	ZX750 G2-G3 (GPz750R)	84→87	D8EA	2120	DR8EVX	6354	DR8EIX	6681	0.7
	ZX750 H1-H2 (ZXR750)	89→91	CR9E	6263			CR9EIX	3521	0.7
	ZX750 J1-J2 (ZXR750)	91→93	CR9E	6263			CR9EIX	3521	0.7
	ZX750 M1-M2 (ZXR750R)	92→94	CR9E	6263			CR9EIX	3521	0.7
	ZX750 L3 (ZXR750)	94→96	CR9E	6263			CR9EIX	3521	0.7
	ZX750 N1 (Ninja ZX-7RR)	96→99	CR9E	6263			CR9EIX	3521	0.7
	ZX750 P1-P7 (Ninja ZX-7R)	96→03	CR9E	6263			CR9EIX	3521	0.7
773	EJ800A (W800)	11→	CR8E	1275			CR8EIX	4218	0.7
800	VN800 A1-3	95→98	CR7E	4578			CR7EIX	7385	0.7
	VN800 B2-B8 (Classic), C1-C2, E1-E2 (Drifter)	96→	CR7E	4578			CR7EIX	7385	0.8
	Z800	14→	CR9EK	4548			CR9EIX	3521	0.7
	Z800E	14→	CR9EK	4548			CR9EIX	3521	0.7
900	VN900 A6F, B7F (Classic)	06→	CPR7EA-9	3901					0.9
	VN900 C7F (Custom)	07→	CPR7EA-9	3901					0.9
	Z1, Z1A, Z1B, Z900 A4	73→76	B8ES	2411			BR8EIX	5044	0.7
	ZX900 A1-A8 (GPZ900R)	84→96	DR8ES	5423	DR9EVX	6361	DR9EIX	4772	0.7
	ZX900 B1-B4 (ZX9R Ninja)	94→98	CR9EK	4548			CR9EIX	3521	0.7
	ZX900 C1-C2, E1-E2 (ZX9R Ninja)	98→	CR9EK	4548			CR9EIX	3521	0.7
	ZX900 F1/H/P, F2/H/P (ZX9R)	02→04	CR9EK	4548			CR9EIX	3521	0.7
1000	KLV1000	05→	CR8EK	3478			CR8EIX	4218	0.7
	Z1000 A1-A3, A4 (Mark II), D1 (Z1-R), E1-E2 (ST), H1 (Fi)	77→81	B8ES	2411			BR8EIX	5044	0.7
	Z1000 J1-J3, R1-R2, K1 (LTD)	81→84	B8ES	2411			BR8EIX	5044	0.7
	ZG1000 A1-A7 (1000GTR)	86→94	DR8ES	5423	DR9EVX	6361	DR9EIX	4772	0.7
	ZG1000 A9-A14 (1000GTR)	94→99	DR9EA	3437	DR9EVX	6361	DR9EIX	4772	0.7
	ZL1000 A1 (ZL1000)	87→90	DR8ES	5423	DR9EVX	6361	DR9EIX	4772	0.7
	ZR1000 A1H-A3H (Z1000)	03→05	CR9EK	4548			CR9EIX	3521	0.7
	ZR1000 A6F (Z1000)	06→07	CR9EK	4548			CR9EIX	3521	0.7
	ZR1000 B7F-B8F, C7F-C8F, DAF (Z1000)	07→09					CR9EIA-9	6289	0.9
	ZX1000 A1-A3 (GPZ1000RX)	85→89	DR8ES	5423	DR9EVX	6361	DR9EIX	4772	0.7
	ZX1000 B1-B3 (ZX-10)	88→91	CR9E	6263			CR9EIX	3521	0.7
	ZX1000 C1H (ZX10R)	04→					CR9EIA-9	6289	0.9
	ZX1000 D6F-D7F, E8F, E9F, FAF (Ninja ZX-10R)	06→					CR9EIA-9	6289	0.9
	1043	KLZ1000 ACF (Versys 1000)	12→					CR9EIA-9	6289
ZR1000 DAF (Z1000)		2010					CR9EIA-9	6289	0.9
ZX1000G, H (Z1000SX, Tourer)		11→					CR9EIA-9	6289	0.9
1100	Z1100 A1-A3 (Shaft drive)	81→85	BR8ES	5422			BR8EIX	5044	0.7
	Z1100 B1-B2 (GPz1100)	81→83	BR8ES	5422			BR8EIX	5044	0.7
	ZR1100 A1-A4 (Zephyr) Twin Spark	92→95	CR9E	6263			CR9EIX	3521	0.7
	ZR1100 B1 (Zephyr) Twin Spark	96→97	CR9E	6263			CR9EIX	3521	0.7
	ZR1100 C1-C4 (ZRX 1100)	97→01	CR9EK	4548			CR9EIX	3521	0.7
	ZX1100 A1-A3 (GPz1100)	83→88	BR8ES	5422			BR8EIX	5044	0.7
	ZX1100 C1-C3, D1-D9 (ZZ-R1100)	90→01	CR9E	6263			CR9EIX	3521	0.7
	ZX1100 E1-E5 (GPZ1100)	95→99	CR9EK	4548			CR9EIX	3521	0.7
	ZX1100 F1 (GPZ1100 ABS)	96→98	CR9EK	4548			CR9EIX	3521	0.7



CC	MODEL	DATE	STANDARD COPPER CORE	STOCK NUMBER	PLATINUM OR GOLD PALLADIUM	STOCK NUMBER	IRIDIUM	STOCK NUMBER	GAP MM
KAWASAKI (CONTINUED)									
1200	ZR1200 A1-A4H, B1-B3P (ZRX 1200)	01→05	CR9EK	4548			CR9EIX	3521	0.7
	ZR1200 A6F (ZRX1200R)	05→	CR9EK	4548			CR9EIX	3521	0.7
	ZX1200 A1-A2 (ZX-12R)	99→01			CR9EKPA	7785	CR9EIX	3521	0.8
	ZX1200 B1H-B3H (Ninja ZX-12R)	02→07			CR9EKPA	7785	CR9EIX	3521	0.8
	ZX1200-C1H/C2H (ZZ-R1200)	02→04	CR9E	6263			CR9EIX	3521	0.7
1300	Z1300 A1	78→79	BR8ES	5422			BR8EIX	5044	0.7
	Z1300 A2-A5	80→83	BPR6ES	7822			BPR6EIX	6637	0.7
	ZG1300 A1-A3 Fuel Injection	84→90	BPR6ES	7822			BPR6EIX	6637	0.7
1352	ZG1400 A8F-CCF (1400GTR)	07→					CR9EIA-9	6289	0.9
	ZX1400 A6F-D8F (ZZ-R1400)	06→11					CR9EIA-9	6289	0.9
1441	ZX1400 ECF (ZZ-R1400)	12→					CR9EIA-9	6289	0.9
1500	VN1500 B2-B6, C1-C2	88→95	DPR7EA-9	5129			DPR7EIX-9	7803	0.9
	VN1500 D1-D2 (VN1500 Classic)	96→98	DPR5EA-9	2887					0.9
	VN1500 E1-E2 (Classic)	98→99	DPR5EA-9	2887					0.8
	VN1500 G2 (Nomad)	1999	DPR5EA-9	2887					0.8
	VN1500 J1-J2 Drifter	99→00	DPR6EA-9	5531					0.9
	VN1500 L1-L4 Fi (Classic Tourer Fi)	99→03	DPR6EA-9	5531					0.9
	VN1500 N1-N3H	99→04	DPR6EA-9	5531					0.9
	VN1500 P1H-P2H (Mean Streak)	01→04	DPR6EA-9	5531					0.9
1552	VN1500 R1-R2H (Drifter)	01→04	DPR6EA-9	5531					0.9
	VN1600 A1H-A7F Classic	03→07	DPR6EA-9	5531					0.9
	VN1600 B1H-B7F Mean Streak	04→07	DPR6EA-9	5531					0.9
1700	VN1600 D1H-D8F Classic Tourer	05→08	DPR6EA-9	5531					0.9
	VN1700 Classic, Classic Tourer, Voyager	09→					ILZKAR7B11	1654	1.1
2050	VN2000 A1H-A6F	04→					IZFR6F11	4095	1.1

KENOS									
125	125-12B	12/07→	CR8E	1275			CR8EIX	4218	0.7

KEEWAY									
50	Hurricane (2-Stroke) Ø14mm Plug	08→	BPR7HS	6422			BPR7HIX	5944	0.6
	Hurricane (4-Stroke) Ø10mm Plug	08→	C7HSA	4629			CR7HIX	7544	0.7
125	ARN 125	08→	DPR7EA-9	5129			DPR7EIX-9	7803	0.9
	Hacker 125	08→	DPR7EA-9	5129			DPR7EIX-9	7803	0.9
	Speed 125	08→	DPR7EA-9	5129			DPR7EIX-9	7803	0.9
	Superlight 125	08→	DPR7EA-9	5129			DPR7EIX-9	7803	0.9

KREIDLER									
50	Florett (RM, RMS, RMC), GS50		B7HS	5110			BR7HIX	7067	0.5
	MC-5-50		B7HS	5110			BR7HIX	7067	0.5

KTM									
50	50 Pro-Junior, Senior (12.7mm Thread Reach)	2000	B8HS	5510	B8HVX	2634	BR8HIX	7001	0.6
	50 Adventure Mini, Junior & Senior (12.7mm Thread Reach)	→02	BR8HS	4322			BR8HIX	7001	0.6
	50 Adventure Mini, Junior & Senior (19mm Thread Reach)	03→08	BR8ECM	3035	BR8ECMVX	5567			0.6
	50 SX Junior/Senior LC (19mm Thread Reach)	2002	BR10EG	3830			BR10EIX	6801	0.6
	50 SX Pro-Junior LC (Beta engine)	2003	BR8ECM	3035	BR8ECMVX	5567			0.6
	50 SX	09→	LR8B	6208	CR8HVX	7236	CR8HIX	7669	0.6
60	60 SX	98→					R7436-10	4900	0.6
65	65 SX	→03	BR10EG	3830			BR10EIX	6801	0.6
	65 SX Beta engine (19mm Thread Reach)	03→07	BR8ECM	3035	BR8ECMVX	5567			0.6
	65 SX KTM engine (12.7mm Thread Reach)	08/08→	LR8B	6208	CR8HVX	7236	CR8HIX	7669	0.6
80	Moto-X models with ½", 12.7mm Thread Reach	→85			B8HVX	2634	BR8HIX	7001	0.6
	80 MX	1986	B10EG	3630	B10EGV	5927	BR10EIX	6801	0.6
85	85 SX	03→06			BR10ECMVX	2457			0.7
	85 SX	07→			BR9ECMVX	2434			0.6
125	Moto-X models with ½", 12.7mm Thread Reach (Not GP)	→85			B8HVX	2634	BR8HIX	7001	0.6
	125 Duke	11→	LKAR8A-9	4786			LKAR8AI-9	6706	0.9
	125 SX	96→97			B10EGV	5927	BR10EIX	6801	0.6



CC	MODEL	DATE	STANDARD COPPER CORE	STOCK NUMBER	PLATINUM OR GOLD PALLADIUM	STOCK NUMBER	IRIDIUM	STOCK NUMBER	GAP MM
KTM (CONTINUED)									
125	125 EXC, EGS, SX	98→00			R6918B-8	4492			0.8
	125 EXC, SX	01→07					BR9EIX	3981	0.6
	125 EXC, EXC, SX, Six Days	08→			BR9ECMVX	2434			0.6
	125 GS	1986	B10EG	3630	B10EGV	5927	BR10EIX	6801	0.6
	125 LC/LCPA	→85	B9EG	3530	B9EGV	5827	BR9EIX	3981	0.6
	125 MX	1986	B10EG	3630	B10EGV	5927	BR10EIX	6801	0.6
	125 MX	87/88	B9EG	3530	B9EGV	5827	BR9EIX	3981	0.6
	125 MX	89/90			B10EVX	7335	BR10EIX	6801	0.6
	125 SM		BR8HS	4322			BR8HIX	7001	0.6
	LC125, LC 2 125 (Duke 125)	96→98	BR9ES	5722			BR9EIX	3981	0.6
	SX 125 (2001)	01→			BR9ECMVX	2434			0.6
144	144 SX	08→			BR9ECMVX	2434			0.6
	150 SX	09→			BR9ECMVX	2434			0.6
175	Moto-X models with ½", 12.7mm Thread Reach	→85			B8HVX	2634	BR8HIX	7001	0.6
200	200 Duke	11→	LKAR8A-9	4786			LKAR8AI-9	6706	0.9
	200 EGS, EXC, MXC	98→	BR8EG	3130			BR8EIX	5044	0.6
	200 EXC, SX	03→					BR9EIX	3981	0.6
	200 EXC	06→	BR8EG	3130			BR8EIX	5044	0.6
	200 XC, XC-W	07→	BR8EG	3130			BR8EIX	5044	0.6
250	Moto-X models with ½", 12.7mm Thread Reach	→85			B8HVX	2634	BR8HIX	7001	0.6
	250 EXC (2-Stroke) Ø14mm Plug	97→02	BR8ECM	3035	BR8ECMVX	5567			0.6
	250 EXC (2-Stroke) Ø14mm Plug	03→	BR7ES	5122			BR7EIX	6664	0.7
	250 EXC Racing (4-Stroke) Ø10mm Plug	01→02	CR8EK	3478			CR8EIX	4218	0.7
	250 EXC Racing (4-Stroke) Ø12mm Plug	03→06	DCPR8E*	4179			DCR8EIX	3606	0.6
	250 EXC-F Incl. Fi (4-Stroke) Ø10mm Plug	07→	CR9EKB	2305			CR9EIX	3521	0.8
	250 GS	1986	B10EG	3630	B10EGV	5927	BR10EIX	6801	0.6
	250 LCPA	→85	B10EG	3630	B10EGV	5927	BR10EIX	6801	0.6
	250 MC/GS	→85	B9EG	3530	B9EGV	5827	BR9EIX	3981	0.6
	250 MX	1986	B10EG	3630	B10EGV	5927	BR10EIX	6801	0.6
	250 MX	87/88	B9EG	3530	B9EGV	5827	BR9EIX	3981	0.6
	250 MX	89/90			B9EVX	7254	BR9EIX	3981	0.6
	250 SX	97→	BR8ECM	3035	BR8ECMVX	5567			0.6
	250 SX (2-Stroke) Ø14mm Plug	03→05	BR8ECM	3035	BR8ECMVX	5567			0.6
	250 SX	06→	BR8ECM	3035	BR8ECMVX	5567			0.6
	250 SX-F (4-Stroke) Ø10mm Plug (19mm Thread Reach)	06→12	CR9EKB	2305			CR9EIX	3521	0.8
	250 SX-F (4-Stroke) Ø10mm Plug (26.5mm Thread Reach)	13→					LMAR9AI-8	97225	0.8
300	300 EXC	97→02	BR8ECM	3035	BR8ECMVX	5567			0.6
	300 EXC	03→06	BR7ES	5122			BR7EIX	6664	0.7
	300 EXC	07→	BR7ES	5122			BR7EIX	6664	0.7
	300 GS	1986	B10EG	3630	B10EGV	5927	BR10EIX	6801	0.6
	300 MXC	97→02	BR8ECM	3035	BR8ECMVX	5567			0.6
	300 MXC	03→	BR7ES	5122			BR7EIX	6664	0.7
	300 XC	06→	BR7ES	5122			BR7EIX	6664	0.7
350	350 EXC-F, Six Days (4-Stroke)	11→					LMAR9AI-8	97225	0.8
	350 MX	87→95	B9EG	3530	B9EGV	5827	BR9EIX	3981	0.6
	350 SX-F	10→					LMAR9AI-8	97225	0.8
	Freeride 350	12→					LMAR9AI-10	93188	1.0
380	380 EXC, 380 SX		BR8ECM	3035	BR8ECMVX	5567			0.6
390	390 GS	→85	B9EG	3530	B9EGV	5827	BR9EIX	3981	0.6
400	Moto-X models with ½", 12.7mm Thread Reach	→85	B9HS	5810	B9HVX	2254	BR9HIX	5687	0.7
	400 EGS-E	97→	DR8EA	7162	DR8EVX	6354	DR8EIX	6681	0.6
	400 EXC, MXC, SX Ø10mm Plug	99→02	CR8EK	3478			CR8EIX	4218	0.7
	400 EXC Ø12mm Plug (19mm Thread Reach)	02→08	DCPR8E*	4179			DCR8EIX	3606	0.6
	400 EXC Ø12mm Plug (26.5mm Thread Reach)	09→					LKAR8AI-9	6706	0.9
	400 LSE		DR8EA	7162	DR8EVX	6354	DR8EIX	6681	0.6
LC4 400		DR8EA	7162	DR8EVX	6354	DR8EIX	6681	0.7	
420	420 AC	→85	B9EG	3530	B9EGV	5827	BR9EIX	3981	0.6
450	450 EXC Racing, SX Racing (4-Stroke)	03→	DCPR8E*	4179			DCR8EIX	3606	0.6
	450 EXC-R (26.5mm Thread Reach)	2008	LKAR8A-9	4786			LKAR8AI-9	6706	0.9
	450 EXC-R, Six Days (26.5mm Thread Reach)	09→					LKAR8AI-9	6706	0.9



* Please note DCPR8E 4339 has a removable terminal nut, whereas DCPR8E 4179 has a fixed terminal nut





CC	MODEL	DATE	STANDARD COPPER CORE	STOCK NUMBER	PLATINUM OR GOLD PALLADIUM	STOCK NUMBER	IRIDIUM	STOCK NUMBER	GAP MM
KTM (CONTINUED)									
450	450 SMR Ø12mm Plug	04→07	DCPR8E*	4179			DCR8EIX	3606	0.6
	450 SMR Ø10mm Plug	08→	CR9EKB	2305			CR9EIX	3521	0.8
	450 SX-F	07→	CR9EKB	2305			CR9EIX	3521	0.8
480	505 SX-F	07→	CR9EKB	2305			CR9EIX	3521	0.8
495	495 AC	→85	B9EG	3530	B9EGV	5827	BR9EIX	3981	0.6
500	500 MX, 500 MXC	1986	B9EG	3530	B9EGV	5827	BR9EIX	3981	0.6
	500 MX	87/88	B9EG	3530	B9EGV	5827	BR9EIX	3981	0.6
	500 MX	89/90			B9EVX	7254	BR9EIX	3981	0.6
510	500 EXC, Six Days	12→					LKAR8AI-9	6706	0.9
	530 EXC-R	07→08	LKAR8A-9	4786			LKAR8AI-9	6706	0.9
	530 EXC-R	09→					LKAR8AI-9	6706	0.9
520	520 EXC, MXC, SX	99→	CR8EK	3478			CR8EIX	4218	0.7
525	525 EXC Racing, MXC, SX	03→	DCPR8E*	4179			DCR8EIX	3606	0.6
560	560-4S	→85	D8EA	2120	DR8EVX	6354	DR8EIX	6681	0.6
600	600-C4S	→85	D8EA	2120	DR8EVX	6354	DR8EIX	6681	0.6
	600 4S	86→88	D8EA	2120	DR8EVX	6354	DR8EIX	6681	0.6
	600 EGS-E		DR8EA	7162	DR8EVX	6354	DR8EIX	6681	0.6
	LC4 640		DR8EA	7162	DR8EVX	6354	DR8EIX	6681	0.7
620	620 Adventure, 620LSE, 620 Duke	97→	DR8EA	7162	DR8EVX	6354	DR8EIX	6681	0.6
625	625 Enduro, Super Moto	02→	DPR8EA-9	4929			DPR8EIX-9	2202	0.9
	625 SMC	03→06	DCPR8E*	4179			DCR8EIX	3606	0.6
	625 SXC	03→	DCPR8E*	4179			DCR8EIX	3606	0.6
	640 LC4, Duke, Duke II	03→	DCPR8E*	4179			DCR8EIX	3606	0.6
	640 Super Moto	02→	DCPR8E*	4179			DCR8EIX	3606	0.6
	R640 Adventure	03→	DCPR8E*	4179			DCR8EIX	3606	0.6
654	660 SMC	03→	DCPR8E*	4179			DCR8EIX	3606	0.6
	690 Duke	07→11					LKAR8AI-9	6706	0.9
	690 Duke R	10→					LKAR8AI-9	6706	0.9
	690 Enduro R	09→11					LKAR8AI-9	6706	0.9
	690 LC4 Supermoto / Prestige	07→					LKAR8AI-9	6706	0.9
	690 SMC	08→					LKAR8AI-9	6706	0.9
	690 SM R	08→					LKAR8AI-9	6706	0.9
690	690 Duke (Twin spark) Ø10mm Plug	12→	LMAR7A-9	4908			LKAR8BI9	1553	0.9
	690 Duke (Twin spark) Ø12mm Plug								
	690 Enduro R	12→					LKAR8AI-9	6706	0.9
950	950 Adventure / Rally	03→	CR8EK	3478			CR8EIX	4218	0.7
	950 Supermoto / Super Enduro R	05→	CR8EK	3478			CR8EIX	4218	0.7
1000	990 Adventure / Supermoto	06→08	DCPR8E*	4339			DCR8EIX	3606	0.9
	990 Adventure / R	09→					LKAR8BI9	1553	0.9
	990 SM-R	09→					KR8DI	4742	0.8
	990 SM-R	12→					LKAR8BI9	1553	0.9
	990 SM-T	09→10					KR8DI	4742	0.8
	990 SM-T ABS	11→					LKAR8BI9	1553	0.9
	990 Super Duke	04→06	DCPR8E*	4339			DCR8EIX	3606	0.9
	990 Super Duke (19mm Thread Reach)	07→11					KR8DI	4742	0.8
	990 Super Duke R (19mm Thread Reach)	07					KR8DI	4742	0.8
	990 Super Duke R (26.5mm Thread Reach)	08→11					LKAR8AI-9	6706	0.9
990 Super Duke R (19mm Thread Reach)	12→					KR8DI	4742	0.8	
1148	1190 RC8	08→10					LKAR9BI9	6205	0.9
1195	1190 Adventure, R (Twin spark) Ø10mm Plug	13→	LMAR7A-9	4908			LKAR9BI9	6205	0.9
	1190 Adventure, R (Twin spark) Ø12mm Plug								
	RC8R (Incl. Track model)	09→11					LKAR9BI9	6205	0.9
	RC8R (Incl. Track model) Twin spark Ø10mm Plug	11→	LMAR7A-9	4908			LKAR9BI9	6205	0.9
	RC8R (Incl. Track model) Twin spark Ø12mm Plug								

KYMCO									
50	Agility 50	05→	CR7HSA	4549			CR7HIX	7544	0.7
	Cobra 50		BR8HSA	5539			BPR8HIX	6742	0.6
	Fever 50		BR8HSA	5539			BPR8HIX	6742	0.6
	Filly 50	98→	CR7HSA	4549			CR7HIX	7544	0.7



* Please note DCPR8E 4339 has a removable terminal nut, whereas DCPR8E 4179 has a fixed terminal nut





CC	MODEL	DATE	STANDARD COPPER CORE	STOCK NUMBER	PLATINUM OR GOLD PALLADIUM	STOCK NUMBER	IRIDIUM	STOCK NUMBER	GAP MM
KYMCO (CONTINUED)									
50	Filly LX 50	99→	CR7HSA	4549			CR7HIX	7544	0.7
	People 50	04→06	BR8HSA	5539			BPR8HIX	6742	0.6
	Scout 50	97→	BR8HSA	5539			BPR8HIX	6742	0.6
	Spacer 50		BR8HSA	5539			BPR8HIX	6742	0.6
	Super 8 50 (2-Stroke) Ø14mm Plug	07→	BR8HSA	5539			BPR8HIX	6742	0.6
	Super 8 50 (4-Stroke) Ø10mm Plug	11→	CR7HSA	4549			CR7HIX	7544	0.7
	Super 9 50 (Liquid Cooled)	99→	BR8HSA	5539			BPR8HIX	6742	0.6
	Super 9 50 (Air Cooled)	01→	BR8HSA	5539			BPR8HIX	6742	0.6
	Super 9 50 (Air Cooled) (Euro 2)	01→	BR8HSA	5539			BPR8HIX	6742	0.6
	Vitality 50 (2-Stroke)	04→	BR8HSA	5539			BPR8HIX	6742	0.6
	Vitality 50 (4-Stroke)		CR7HSA	4549			CR7HIX	7544	0.7
	Yup 50	00→	BR8HSA	5539			BPR8HIX	6742	0.6
	ZX 50		BR8HSA	5539			BPR8HIX	6742	0.6
100	Cobra 100	99→	BR6HSA	4296			BPR6HIX	4085	0.7
125	Agility 125	05→	CR7HSA	4549			CR7HIX	7544	0.7
	CK125	05→	DR8EA	7162	DR8EVX	6354	DR8EIX	6681	0.7
	Cruiser 125	03→	CR8E	1275			CR8EIX	4218	0.7
	Downtown 125i	13→	CR7E	4578			CR7EIX	7385	0.7
	Ego 125		DPR7EA-9	5129			DPR7EIX-9	7803	0.9
	Heroism 125		C7HSA	4629			CR7HIX	7544	0.7
	Hipster 125 (2 Valve)	01→	DR8EA	7162	DR8EVX	6354	DR8EIX	6681	0.7
	Hipster 125 (4 Valve)		CR8E	1275			CR8EIX	4218	0.7
	Hipster 125 (4 Valve) (Euro 2)		CR8E	1275			CR8EIX	4218	0.7
	Miler 125 (Grand Dink)	03→	DPR7EA-9	5129			DPR7EIX-9	7803	0.9
	Movie XL125	02→	CR7HSA	4549			CR7HIX	7544	0.7
	People One 125i	13→	CR7E	4578			CR7EIX	7385	0.7
	People S 125 (Euro 3)	05→	CR7HSA	4549			CR7HIX	7544	0.7
	Pulsar 125		DR8EA	7162	DR8EVX	6354	DR8EIX	6681	0.7
	Sector 125		DR8EA	7162	DR8EVX	6354	DR8EIX	6681	0.7
	Spacer 125 (Liquid Cooled)		DPR7EA-9	5129			DPR7EIX-9	7803	0.9
	Stryker 125		DR8EA	7162	DR8EVX	6354	DR8EIX	6681	0.7
	Super 8 125 Ø12mm Plug	07→	DPR7EA-9	5129			DPR7EIX-9	7803	0.9
	Super 8 125 (4-Stroke) Ø10mm Plug		CR7HSA	4549			CR7HIX	7544	0.7
	Vivio 125		CR7HSA	4549			CR7HIX	7544	0.7
Yager GT125	08→	DPR7EA-9	5129			DPR7EIX-9	7803	0.9	
Zing 125	97→	DR8EA	7162	DR8EVX	6354	DR8EIX	6681	0.7	
200	Yager 200i		DPR6EA-9	5531					0.9
250	Dink 250		DPR7EA-9	5129			DPR7EIX-9	7803	0.9
	Ego 250		DPR7EA-9	5129			DPR7EIX-9	7803	0.9
	Grand Dink 250	01→	DPR7EA-9	5129			DPR7EIX-9	7803	0.9
	People 250	05→	DPR7EA-9	5129			DPR7EIX-9	7803	0.9
	Venox 250	03→	CR8E	1275			CR8EIX	4218	0.7
	Xciting 250i	06→	DPR6EA-9	5531					0.9
300	Downtown 300i	11→	CR7E	4578			CR7EIX	7385	0.7
500	Xciting 500 (Carb)	05→06	CR8E	1275			CR8EIX	4218	0.7
	Xciting 500i	07→	CR7E	4578			CR7EIX	7385	0.7

LAMBRETTA									
125	LI 125, SL125, SI 125		B7ES	1111			BR7EIX	6664	0.5
150	GP 150	76→98	B7ES	1111			BR7EIX	6664	0.5
200	GP 200, SXJet 200, SX200, Links 200	78→	B7ES	1111			BR7EIX	6664	0.5

LAVERDA									
500	500 Alpino S, Montjuic	78→84	D9EA	2420	DR9EVX	6361	DR9EIX	4772	0.7
650	650 i.e., Sport, Formula, Ghost, Diamante	94→98	DCPR9E	2641	DCPR9EVX	6436	DCPR9EIX	2316	0.6
	650, GT, GTL, American Eagle	94→98	B9ES	2611	B9EVX	7254	BR9EIX	3981	0.7
668	668, Ghost, Ghost Strike	96→98	DCPR9E	2641	DCPR9EVX	6436	DCPR9EIX	2316	0.6
750	750, GT, GTL, American Eagle		B8ES	2611			BR8EIX	5044	0.7
	750 S, Ghost 750 Strike, Diamante 750, 750 S Formula	97→02	DCPR9E	2641	DCPR9EVX	6436	DCPR9EIX	2316	0.6
	SF, SFL, SF2, SF3, SFC Twins	68→78	B8ES	2611			BR8EIX	5044	0.7



CC	MODEL	DATE	STANDARD COPPER CORE	STOCK NUMBER	PLATINUM OR GOLD PALLADIUM	STOCK NUMBER	IRIDIUM	STOCK NUMBER	GAP MM
LAVERDA (CONTINUED)									
1000	1000EC, 3C(E), 1000 2CL, Jota, Jarama	76→82	B8ES	2411			BR8EIX	5044	0.7
	RGA, RGS	82→87	B8ES	2411			BR8EIX	5044	0.7
	SFC	85→89	B9ES	2611	B9EVX	7254	BR9EIX	3981	0.7
1200	1200, T, Mirage, TS, Jota American	78→83	B8ES	2411			BR8EIX	5044	0.7

LEM									
50	LX 1,2,3,4 Super & Sport 50 (12.7mm Thread Reach)		B7HS	5110			BR7HIX	7067	0.6
	LX4 (19mm Thread Reach)		BR9ES	5722			BR9EIX	3981	0.7
	S6 Racer (Reed valve engine) 50				B105EGV	2171			0.6

LEXMOTO									
50	Flash ZN50QT-15A		C7HSA	4629			CR7HIX	7544	0.7
	LSM 50	12→	BR8ES	5422			BR8EIX	5044	0.6
	Tornado SB50QT-16(B08)		C7HSA	4629			CR7HIX	7544	0.7
	Tommy ZN50QT-A		C7HSA	4629			CR7HIX	7544	0.7
	Tommy II ZN50QT-E		C7HSA	4629			CR7HIX	7544	0.7
125	Arizona ZS125-30		D8EA	2120			DR8EIX	6681	0.7
	Arrow HT125-4F		D8EA	2120			DR8EIX	6681	0.7
	Firenze ZN125T-F		C7HSA	4629			CR7HIX	7544	0.7
	Gladiator SB125T-23B		C7HSA	4629			CR7HIX	7544	0.7
	Ranger ZS125-50		D8EA	2120			DR8EIX	6681	0.7
	Street DFE125-8A		CR7E	4578			CR7EIX	7385	0.7
	Tommy ZN125T-E		C7HSA	4629			CR7HIX	7544	0.7
	Tornado SB125T-21(B08)		C7HSA	4629			CR7HIX	7544	0.7
	Valencia	12→	C7HSA	4629			CR7HIX	7544	0.7
	Vixen HT125-8		D8EA	2120			DR8EIX	6681	0.7
	XTR KS125-23		D8EA	2120			DR8EIX	6681	0.7
	XTR S KS125-24		D8EA	2120			DR8EIX	6681	0.7
	Zoom II SB125T-21(B10)		C7HSA	4629			CR7HIX	7544	0.7

LIFAN									
50	Echo (LF50QT-8D)		C7HSA	4629			CR7HIX	7544	0.6
	Jet 50		C7HSA	4629			CR7HIX	7544	0.7
110	Wacky 110		C7HSA	4629			CR7HIX	7544	0.7
125	Beat 125 (LF125-9A)		C7HSA	4629			CR7HIX	7544	0.6
	Earth Dragon		D8EA	2120			DR8EIX	6681	0.7
	Mirage 125 (LF125-J)		D8EA	2120	DR8EVX	6354	DR8EIX	6681	0.6

LML									
125	Star Deluxe 2-Stroke		BP8HS	2630			BPR8HIX	6742	0.7
	Star Deluxe 4-Stroke	11/09→	CR8EH-9	5666			CR8EHIX-9	3797	0.7
	Via Toscana 2-Stroke	09→	BP8HS	2630			BPR8HIX	6742	0.7
150	Star Deluxe 2-Stroke		BPR6ES	7822			BPR6EIX	6637	0.7
	Star Deluxe 4-Stroke	11/09→	CR8EH-9	5666			CR8EHIX-9	3797	0.7

MAGNI									
1000	Australia		D9EA	2420	DR9EVX	6361	DR9EIX	4772	0.7
	Sfida 1000		BP6ES	7811	BP6EVX	5832	BPR6EIX	6637	0.5
	Sfida Ottovalvole				DR9EVX	6361	DR9EIX	4772	0.6

MAICO									
Various	Moto-X models with 1/2", 12.7mm Thread Reach				B9HVX	2254	BR9HIX	5687	0.5
	Moto-X models with 3/4", 19mm Thread Reach		B9EG	3530	B9EGV	5827	BR9EIX	3981	0.5



CC	MODEL	DATE	STANDARD COPPER CORE	STOCK NUMBER	PLATINUM OR GOLD PALLADIUM	STOCK NUMBER	IRIDIUM	STOCK NUMBER	GAP MM
MALAGUTI									
50	Ciak 50	00→02	BR8HS	4322			BR8HIX	7001	0.6
	Crosser	99→01	BPR6HS	7022			BPR6HIX	4085	0.5
	F-10 Jetline	96→06	BR7HS	4122			BR7HIX	7067	0.5
	F-12 Dragon	96→	BR7HS	4122			BR7HIX	7067	0.5
	F-12 Phantom	96→06	BR7HS	4122			BR7HIX	7067	0.5
	F-15 Firefox	97→	BR8HS	4322			BR8HIX	7001	0.5
	Foggy Replica		BR8HS	4322			BR8HIX	7001	0.5
	RCX10 (50cc Franco Morini)		B7HS	5110			BR7HIX	7067	0.5
	RCX12 (50cc Franco Morini)		B7HS	5110			BR7HIX	7067	0.5
	Wild Attack F12		BR8HS	4322			BR8HIX	7001	0.5
Yesterday 50	98→00	BR8HS	4322			BR8HIX	7001	0.5	
70	F-69 Phantom	97→99	BR7HS	4122			BR7HIX	7067	0.5
100	Ciak 100	00→04	BR8HS	4322			BR8HIX	7001	0.6
	F-12 Phantom 100TD	99→	BR7HS	4122			BR7HIX	7067	0.6
125	Ciak 125	01→04	BR7HS	4122			BR7HIX	7067	0.6
	Madison 125	99→04	CR8E	1275			CR8EIX	4218	0.7
150	F-18 Warrior	01→	DPR7EA-9	5129			DPR7EIX-9	7803	0.9
250	Madison 250cc	99→04	DPR9EA-9	5329			DPR9EIX-9	5545	0.9
400	Madison K400	02→04	CR9E	6263			CR9EIX	3521	0.7
500	Spidermax 500 GT	04→	CR7EKB	4455			CR7EIX	7385	0.8

MBK									
50	Booster 50 NG	99→02	BR8HS	4322			BR8HIX	7001	0.5
	Flipper 50		BR8HS	4322			BR8HIX	7001	0.5
	Mach-G (Air Cooled)		BR8HS	4322			BR8HIX	7001	0.6
	Mach-G (Liquid Cooled)		BR8HS	4322			BR8HIX	7001	0.6
	Nitro 50	99→	BR8HS	4322			BR8HIX	7001	0.5
	Nitro-Jaguar F1		BR8HS	4322			BR8HIX	7001	0.5
	Ovetto 50	99→	BR7HS	4122			BR7HIX	7067	0.6
	Stunt 50	00→	BR9HS	4522			BR9HIX	5687	0.6
	X-Limit 50 Supermotard, Enduro	05→	BR9ES	5722			BR9EIX	3981	0.7
	X-Power 50	03→	BR9ES	5722			BR9EIX	3981	0.7
100	Nitro 100	01→	BR8HS	4322			BR8HIX	7001	0.5
	Ovetto 100	01→	BR8HS	4322			BR8HIX	7001	0.6
125	Doodo 125	01→	CR8E	1275			CR8EIX	4218	0.7
	Flame X 125		CR7E	4578			CR7EIX	7385	0.8
	Skycruiser 125	06→	CPR9EA-9	2308					0.9
	Skyliner 125	01→	CR8E	1275			CR8EIX	4218	0.7
	Thunder 125	01→	CR8E	1275			CR8EIX	4218	0.7
260	Kilibre 300	03→	DR8EA	7162	DR8EVX	6354	DR8EIX	6681	0.7

MONTESA									
123	Cota 123		B6ES	7310					0.5
125	MH123 (Honda engine)		BR7ES	5122			BR7EIX	6664	0.7
175	Cota 172		B6ES	7310					0.5
	Cota 200		B6ES	7310					0.5
200	MH200 (Honda engine)		BPR7ES	2023			BPR7EIX	4055	0.5
250	310		BPR7ES	2023			BPR7EIX	4055	0.5
	Cota 242		BP6ES	7811	BP6EVX	5832	BPR6EIX	6637	0.5
	Cota 247		B6HS	4510			BR6HIX	3419	0.6
	Cota 248		BP5ES	6511			BPR5EIX	6597	0.5
	Cota 315 (Honda engine)	97→99	BR6ES	4922					0.6
	Cota 4T (Honda engine)	05→	CR6EH-9	2688			CR6EIA-9	7967	0.9
260	304, 307, 309		BPR5ES	7422			BPR5EIX	6597	0.5
	311		BPR5ES	7422			BPR5EIX	6597	0.5
	314		BR6ES	4922					0.6
310	348		BPR5ES	7422			BPR5EIX	6597	0.5
330	330		BPR5ES	7422			BPR5EIX	6597	0.5
350	335		BPR5ES	7422			BPR5EIX	6597	0.5
	Cota 349		BP5ES	6511			BPR5EIX	6597	0.5



CC	MODEL	DATE	STANDARD COPPER CORE	STOCK NUMBER	PLATINUM OR GOLD PALLADIUM	STOCK NUMBER	IRIDIUM	STOCK NUMBER	GAP MM
MOTO GUZZI									
350	V35	84→87	B8ES	2411			BR8EIX	5044	0.5
500	V50	79→86	B8ES	2411			BR8EIX	5044	0.5
650	V65	84→93	B8ES	2411			BR8EIX	5044	0.5
750	Breva 750 i.e.	04→	BR8ES	5422			BR8EIX	5044	0.6
	Nevada 750 NT/Nevada club (with Digiplex)		BR8ES	5422			BR8EIX	5044	0.6
	V7 Classic	07/08→12	BR8ES	5422			BR8EIX	5044	0.6
	V7 Café Classic	09→	BR8ES	5422			BR8EIX	5044	0.6
	V7 Café Racer Ø14mm Plug	11/10→11	BR8ES	5422			BR8EIX	5044	0.6
	V7 Café Racer Ø10mm Plug	12→	CPR8EB-9	6607					0.9
	V7 Special, Stone Ø10mm Plug	12→	CPR8EB-9	6607					0.9
850	V75	86→88	B8ES	2411			BR8EIX	5044	0.5
	Le Mans II & III	78→82	BP6ES	7811	BP6EVX	5832	BPR6EIX	6637	0.7
	Series V850		BP6ES	7811	BP6EVX	5832	BPR6EIX	6637	0.7
940	Bellagio 940 (Twin Spark)	07→				PMR8B	6378		0.7
	Ø10mm Plug Ø14mm Plug		BPR6ES	7822			BPR6EIX	6637	0.7
1000	California III I.E.		BP7ES	2412	BP7EVX	7270	BPR7EIX	4055	0.5
	California III with Digiplex		BP7ES	2412	BP7EVX	7270	BPR7EIX	4055	0.5
	Centaurio V10, Centaurio Sport/GT	97→00	DR9EA	3437	DR9EVX	6361	DR9EIX	4772	0.6
	Daytona 1000	92→	D9EA	2420	DR9EVX	6361	DR9EIX	4772	0.7
	Daytona 1000 RS	96→00	DR9EA	3437	DR9EVX	6361	DR9EIX	4772	0.6
	Le Mans IV 1000	82→03/85	BP7ES	2412	BP7EVX	7270	BPR7EIX	4055	0.5
	Le Mans V (Le Mans 1000)	85→94	BP7ES	2412	BP7EVX	7270	BPR7EIX	4055	0.5
	Quota 1000	92→	BP7ES	2412	BP7EVX	7270	BPR7EIX	4055	0.5
	Series 1000		BP6ES	7811	BP6EVX	5832	BPR6EIX	6637	0.7
1100	Breva V 1100 (Twin Spark)	05→				PMR8B	6378		0.7
	Ø10mm Plug Ø14mm Plug		BPR6ES	7822			BPR6EIX	6637	0.7
	California 1100 Carb	94→96	BPR6ES	7822			BPR6EIX	6637	0.6
	California 1100 Inj (Inc. EV, Jackal, Special, Stone & Touring)	94→	BPR6ES	7822			BPR6EIX	6637	0.7
	California Vintage (Twin Spark)	06→				PMR8B	6378		0.7
	Ø10mm Plug Ø14mm Plug		BPR6ES	7822			BPR6EIX	6637	0.7
	Griso 1100 (Twin Spark)	05→				PMR8B	6378		0.7
	Ø10mm Plug Ø14mm Plug		BPR6ES	7822			BPR6EIX	6637	0.7
	Quota 1100 ES	98→01	BPR6ES	7822			BPR6EIX	6637	0.5
	Sport 1100 (Carb)	94→08/96	BP6ES	7811	BP6EVX	5832	BPR6EIX	6637	0.7
	Sport 1100 (Injection)	96→99	BPR6ES	7822			BPR6EIX	6637	0.6
V11 (Twin Spark)	05→				PMR8B	6378		0.7	
		Ø10mm Plug Ø14mm Plug	BPR6ES	7822			BPR6EIX	6637	0.7
	V11 1100cc	01→	BPR6ES	7822			BPR6EIX	6637	0.6
	V11 Le Mans	03→	BPR6ES	7822			BPR6EIX	6637	0.6
1150	Breva V 1200 (Twin Spark)	08→				PMR8B	6378		0.7
	Ø10mm Plug Ø14mm Plug		BPR6ES	7822			BPR6EIX	6637	0.7
	Griso 8V	08→				PMR8B	6378		0.7
	Griso 8V SE	09→				PMR8B	6378		0.7
	Norge 1200 (Twin Spark)	06→				PMR8B	6378		0.7
	Ø10mm Plug Ø14mm Plug		BPR6ES	7822			BPR6EIX	6637	0.7
	Sport 1200 (Twin Spark)	07→08				PMR8B	6378		0.7
	Ø10mm Plug Ø14mm Plug	BPR6ES	7822			BPR6EIX	6637	0.7	
Sport 1200 V4	09→				PMR8B	6378		0.7	
Stelvio 1200 4V	08→				PMR8B	6378		0.7	
Stelvio 1200 TT (NTX)	09→				PMR8B	6378		0.7	
1225	MGS-01 Corsa	05→					DCPR9EIX	2316	0.6

MOTO HISPANIA									
50	Furia 50, Furia Cross (½", 12.7mm Thread Reach)		BPR7HS	6422			BPR7HIX	5944	0.6
	Furia 50, Furia Cross (¾", 19mm Thread Reach)	99→	BR9ES	5722			BR9EIX	3981	0.6
	RX50		BR9ES	5722			BR9EIX	3981	0.6
	RYZ 50 Cross, Supermoto		BR9ES	5722			BR9EIX	3981	0.6
125	RYZ 125 (Yamaha engine)		CR7HSA	4549			CR7HIX	7544	0.6

2 Wheel



CC	MODEL	DATE	STANDARD COPPER CORE	STOCK NUMBER	PLATINUM OR GOLD PALLADIUM	STOCK NUMBER	IRIDIUM	STOCK NUMBER	GAP MM
MOTO MORINI									
250	250, Sport	80→85	BP7ES	2412	BP7EVX	7270	BPR7EIX	4055	0.7
350	350 3½ Sport/Strada	74→84	BP7ES	2412	BP7EVX	7270	BPR7EIX	4055	0.7
	Kanguro 350	82→87	BP7ES	2412	BP7EVX	7270	BPR7EIX	4055	0.7
500	Excaliber 500/501	86→93	BP8ES	2912	BP8EVX	2671	BPR8EIX	6684	0.5
	Maestro	81→	BP7ES	2412	BP7EVX	7270	BPR7EIX	4055	0.7
	Sahara 500	81→89	BP7ES	2412	BP7EVX	7270	BPR7EIX	4055	0.7
1187	9½	06→	CR9E	6263			CR9EIX	3521	0.7
	Corsaro	06→	CR9E	6263			CR9EIX	3521	0.7

MOTO ROMA									
50	Bee 50		BPR7HS	6422			BPR7HIX	5944	0.6
	GoGo 50	02→	BPR7HS	6422			BPR7HIX	5944	0.6
	Grand Prix 50		BPR7HS	6422			BPR7HIX	5944	0.6
	MRX1		B8HS	5510	B8HVX	2634	BR8HIX	7001	0.6
	MRX2		B8HS	5510	B8HVX	2634	BR8HIX	7001	0.6
	MRX2 Sprint	02→	B7HS	5110			BR7HIX	7067	0.6
	MRX3	02→	B6HS	4510			BR6HIX	3419	0.6
	MRX3 Sprint	02→	B7HS	5110			BR7HIX	7067	0.6
	MRX4	03→	BR10ES	4832			BR10EIX	6801	0.7
	Roadrunner 50		BP7HS	5111			BPR7HIX	5944	0.6
	RT 50 (2-Stroke)	02→	BPR7HS	6422			BPR7HIX	5944	0.6
	Scrambler 50		BPR7HS	6422			BPR7HIX	5944	0.6
	Stinger, Stinger II		BPR7HS	6422			BPR7HIX	5944	0.6
	Wasp		BPR7HS	6422			BPR7HIX	5944	0.6
Wasp II		BPR7HS	6422			BPR7HIX	5944	0.6	
90	RT 90 (4-Stroke)	02→	BPR7HS	6422			BPR7HIX	5944	0.6
100	Grand Prix 100		BPR7HS	6422			BPR7HIX	5944	0.6
	Roadrunner 100		BPR7HS	6422			BPR7HIX	5944	0.6
110	GoGo 110	02→	CR7HS	7223			CR7HIX	7544	0.6
125	Grand Prix 125		CR7HS	7223			CR7HIX	7544	0.6
	MRX125	02→	D8EA	2120	DR8EVX	6354	DR8EIX	6681	0.6
	MRX125B		CR7HSA	4549			CR7HIX	7544	0.6
	Road Runner 125	02→	C7HSA	4629			CR7HIX	7544	0.6
	SK125	10→	DR8EA	7162	DR8EVX	6354	DR8EIX	6681	0.6
	SMX125		CR7HSA	4549			CR7HIX	7544	0.6
	Virage 125		D8EA	2120	DR8EVX	6354	DR8EIX	6681	0.6

MOTOBECANE									
50	All Models		B5HS	4210					0.4

MS									
50	Sprite		BP6ES	7811	BP6EVX	5832	BPR6EIX	6637	0.7
	Steward		BP6ES	7811	BP6EVX	5832	BPR6EIX	6637	0.7

MV AGUSTA									
675	Brutale 675 Trepistone	02/12→	CR9EKB	2305			CR9EIX	3521	0.8
	F3 (Incl. Serie Oro)	11/11→	CR9EKB	2305			CR9EIX	3521	0.8
750	Brutale S	02→06	CR9EKB	2305			CR9EIX	3521	0.8
	F4, F4S 1+1, F4 SPR	99→04	CR9EKB	2305			CR9EIX	3521	0.8
	F4 Senna	02→04	CR9EKB	2305			CR9EIX	3521	0.8
	F4 all models, track/race use only.	99→04	R0045J-10	7400					1.1
910	Brutale 910, 910 R, 910 S	05→08	CR9EKB	2305			CR9EIX	3521	0.8
1000	F4 1000 S	04→09	CR9EKB	2305			CR9EIX	3521	0.8
	F4 all models, track/race use only.	04→	R0045J-10	7400					1.1
1078	Brutale 1078 RR	08→	CR9EB	6955			CR9EIX	3521	0.7
	F4 RR 312	08→09	CR9EB	6955			CR9EIX	3521	0.7



CC	MODEL	DATE	STANDARD COPPER CORE	STOCK NUMBER	PLATINUM OR GOLD PALLADIUM	STOCK NUMBER	IRIDIUM	STOCK NUMBER	GAP MM
MZ									
50	Moskito 50		BR7HS	4122			BR7HIX	7067	0.7
	Moskito SX 50		BR7HS	4122			BR7HIX	7067	0.9
125	ETZ 125	86→99	B8HS	5510	B8HVX	2634	BR8HIX	7001	0.6
	Moskito 125		C7HSA	4629			CR7HIX	7544	0.6
	RT/SX/SM 125		CR8E	1275			CR8EIX	4218	0.7
	Saxon Sportstar 125		B8HS	5510	B8HVX	2634	BR8HIX	7001	0.7
	TS125	76→86	B8HS	5510	B8HVX	2634	BR8HIX	7001	0.6
150	ETZ 150	86→95	B8HS	5510	B8HVX	2634	BR8HIX	7001	0.6
	TS150	75→86	B8HS	5510	B8HVX	2634	BR8HIX	7001	0.6
250	ETZ 250/251	81→97	B8HS	5510	B8HVX	2634	BR8HIX	7001	0.6
	TS250-1	76→83	B8HS	5510	B8HVX	2634	BR8HIX	7001	0.6
300	ETZ 300/301 Series	87→97	B8HS	5510	B8HVX	2634	BR8HIX	7001	0.6
500	MZ500, 500R	92→96	D8EA	2120	DR8EVX	6354	DR8EIX	6681	0.7
	Saxon (494cc Rotax engine) Country, Silver Star, Tour	93→98	D8EA	2120	DR8EVX	6354	DR8EIX	6681	0.7
650	Baghira, Black Panther, Mastiff, Supermoto	98→	DPR8EA-9	4929			DPR8EIX-9	2202	0.9
659	Skorpion 659 Replica, Sport, Tour, Traveller	94→	DPR8EA-9	4929			DPR8EIX-9	2202	0.9
	Skorpion Cup 659cc		DPR9EA-9	5329			DPR9EIX-9	5545	0.9
1000	1000S, SF, ST	04→	BCPR6ET	2197			BKR6EIX	6418	0.8

NEVAL									
650	Dnepr Classic, Roadster, Phoenix, Soviet, Soviet Knight	78→	B7HS	5110			BR7HIX	7067	0.5
	Ural 650cc	85→	B6HS	4510			BR6HIX	3419	0.6

NIPPONIA									
50	Neon	12→	BPR7HS	6422			BPR7HIX	5944	0.6
125	Dion	12→	CR7HSA	4549			CR7HIX	7544	0.6
	Miro	12→	CR7HSA	4549			CR7HIX	7544	0.6

NORTON									
750	Atlas	64→68	BP8ES	2912	BP8EVX	2671	BPR8EIX	6684	0.6
	Commando	68→73	BP7ES	2412	BP7EVX	7270	BPR7EIX	4055	0.6
850	Commando	73→78	BP7ES	2412	BP7EVX	7270	BPR7EIX	4055	0.6
961	Commando SE	10→	CR9EB	6955			CR9EIX	3521	0.8
	Commando Café Racer	11→	CR9EB	6955			CR9EIX	3521	0.8
	Commando Sport	10→	CR9EB	6955			CR9EIX	3521	0.8
Rotary	F1, Commander	88→93	C8E	7471			CR8EIX	4218	0.6

OSSA									
272	TR280i	11→	BPR5ES	7422			BPR5EIX	6597	0.5

PEUGEOT									
50	Buxy / Buxy RS 50 (Air Cooled)	95→97	B7HS	5110			BR7HIX	7067	0.6
	Elyseo 50 (Air Cooled)	98→	BR7HS	4122			BR7HIX	7067	0.6
	Elystar 50P	02→05	CPR8E	7411			CR8EIX	4218	0.8
	Jet Force 50	03→	CPR8E	7411			CR8EIX	4218	0.8
	Jet Force C-Tech	06→	CR7EB	4663			CR7EIX	7385	0.6
	Jet Force TSDI	05→	CR7EKA	1462			CR7EIX	7385	0.7
	Looxor 50	01→04	BR7HS	4122			BR7HIX	7067	0.6
	Looxor 50 TSDI Inj. (2-Stroke)	02→	CPR8E	7411			CR8EIX	4218	0.8
	Ludix 50 Blaster, Elegance, Snake Ø14mm Plug	04→07	BR7HS	4122			BR7HIX	7067	0.6
	Ludix Blaster Ø10mm Plug	08→	CR7EB	4663			CR7EIX	7385	0.6
	Ludix Blaster RS12 Ø10mm Plug	06→	CR7EB	4663			CR7EIX	7385	0.6
	Metal-X	02→	BR7HS	4122			BR7HIX	7067	0.6
	Speedake 50 (Air Cooled)	95→97	BR7HS	4122			BR7HIX	7067	0.6
	Speedfight 50 (All models Air Cooled)	96→00	BR7HS	4122			BR7HIX	7067	0.6
	Speedfight 50 LCD/P (Liquid Cooled)	96→00	BR7HS	4122			BR7HIX	7067	0.6
	Speedfight 2 50 (Air Cooled)	00→	BR7HS	4122			BR7HIX	7067	0.6



CC	MODEL	DATE	STANDARD COPPER CORE	STOCK NUMBER	PLATINUM OR GOLD PALLADIUM	STOCK NUMBER	IRIDIUM	STOCK NUMBER	GAP MM
PEUGEOT (CONTINUED)									
50	Speedfight 2 50 (Liquid Cooled)	01→	BR7HS	4122			BR7HIX	7067	0.6
	Speedfight 2 Motorsport 50 LC	07→	BR7HS	4122			BR7HIX	7067	0.6
	Speedfight 3 Air (Air Cooled)	09→	BR7HS	4122			BR7HIX	7067	0.6
	Speedfight 3 Darkside, Iceblade, Liquid, Team (Liquid Cooled)	09→	CR7EB	4663			CR7EIX	7385	0.6
	Squab (Air Cooled)	96→97	BR7HS	4122			BR7HIX	7067	0.6
	TKR 50	03→	BR7HS	4122			BR7HIX	7067	0.6
	TKR 50 307 WRC	05→	BR7HS	4122			BR7HIX	7067	0.6
	Trekker 50 Road, Off Road	97→04	BR7HS	4122			BR7HIX	7067	0.6
	Tweet 50	12→	CR6HSA	2983			CR6HIX	7274	0.7
	Vivacity 50, Vivacity 50P	99→	BR7HS	4122			BR7HIX	7067	0.6
	Vivacity 50 Sportline	00→	BR7HS	4122			BR7HIX	7067	0.6
	Vivacity 3 Sixties	11→	CR6HSA	2983			CR6HIX	7274	0.7
	V-Clic	07→	CR7HSA	4549			CR7HIX	7544	0.6
	XPS 50 Enduro, Trail, Supermotard 50	03→	BR9ES	5722			BR9EIX	3981	0.7
	XR6 50	03→	BR9ES	5722			BR9EIX	3981	0.7
	Zenith 50 L, M, LS, N	95→00	BR7HS	4122			BR7HIX	7067	0.6
100	Elyseo 100	98→	BR8ES	5422			BR8EIX	5044	0.6
	Looxor 100	01→04	BR8ES	5422			BR8EIX	5044	0.6
	Metal X 100	02→	BR8ES	5422			BR8EIX	5044	0.6
	Speedfight 100 (Air Cooled)	97→	BR8ES	5422			BR8EIX	5044	0.6
	Speedfight WRC 206 (Air Cooled)	01→	BR8ES	5422			BR8EIX	5044	0.6
	Speedfight 2	00→08	BR8ES	5422			BR8EIX	5044	0.6
	Trekker 100 (Air Cooled)	97→00	BR8ES	5422			BR8EIX	5044	0.6
	Vivacity 100, Vivacity 100 Sportline	99→08	BR8ES	5422			BR8EIX	5044	0.6
125	Citystar	11→	CR8EB	7784			CR8EIX	4218	0.8
	Elyseo 125 (Liquid Cooled)	99→	CR7E	4578			CR7EIX	7385	0.6
	Elystar 125	02→05	CR7EB	4663			CR7EIX	7385	0.6
	Elystar 125 Injection	05→11	CR7EB	4663			CR7EIX	7385	0.6
	Geopolis Executive 125	07→	CR9EB	6955			CR9EIX	3521	0.6
	Jet Force F.I.	03→	CR7EB	4663			CR7EIX	7385	0.6
	Jet Force EFI Compressor	05→	CR8EK	3478			CR8EIX	4218	0.7
	Looxor 125	02→	CR7EB	4663			CR7EIX	7385	0.6
	Satelis 125	05→	CR9EB	6955			CR9EIX	3521	0.6
	Satelis 125 Compressor	07→	CR9EB	6955			CR9EIX	3521	0.6
	Satelis 125 Executive	06→	CR9EB	6955			CR9EIX	3521	0.6
	Sum Up 125	08→	CR7HSA	4549			CR7HIX	7544	0.7
	SV125	91→94	BP6HS	4511			BPR6HIX	4085	0.6
XPS CT125	06→08	CR7HSA	4549			CR7HIX	7544	0.7	
150	Elyseo 150 (Liquid Cooled)	00→02	CR7E	4578			CR7EIX	7385	0.6
	Elystar 150	02→	CR7EB	4663			CR7EIX	7385	0.6
	Looxor 150	02→	CR7EB	4663			CR7EIX	7385	0.6
250	Geopolis Executive 250	07→	CR9EB	6955			CR9EIX	3521	0.6
	Satelis 250	07→	CR9EB	6955			CR9EIX	3521	0.6
500	Satelis 500	08→	CR7EKB	4455			CR7EIX	7385	0.8

PGO									
50	Big Max, Galaxy 50, G-Max, Mega, Tornado	04→	BPR7HS	6422			BPR7HIX	5944	0.6
	Comet 50, PMX Sport 50, Rodoshow 50, T-Rex 50	98→	BPR7HS	6422			BPR7HIX	5944	0.6
	Libra 50	08→	BPR7HS	6422			BPR7HIX	5944	0.6
	Ligero 50	08→	BPR7HS	6422			BPR7HIX	5944	0.6
	PMX Naked 50	07→	BPR7HS	6422			BPR7HIX	5944	0.6
125	G-Max 125	05→	CR7HSA	4549			CR7HIX	7544	0.6
	Libra 125	08→	C7HSA	4629			CR7HIX	7544	0.6
	Ligero 125	08→	C7HSA	4629			CR7HIX	7544	0.6
	T-Rex 125	98→	CR7HSA	4549			CR7HIX	7544	0.6
250	G-Max 250	05→07	DPR7EA-9	5129			DPR7EIX-9	7803	0.7



CC	MODEL	DATE	STANDARD COPPER CORE	STOCK NUMBER	PLATINUM OR GOLD PALLADIUM	STOCK NUMBER	IRIDIUM	STOCK NUMBER	GAP MM
PIAGGIO / VESPA									
50	50 Special	83→	B6HS	4510			BR6HIX	3419	0.5
	Fly 50 (2-Stroke)	04→	BR9ES	5722			BR9EIX	3981	0.6
	Fly 50 (4-Stroke)	06→	CR8EB	7784			CR8EIX	4218	0.8
	Free 50 (All versions)	93→97	BR9ES	5722			BR9EIX	3981	0.5
	Liberty 50 (2-Stroke)	97→	BR9ES	5722			BR9EIX	3981	0.5
	Liberty 50 (4-Stroke)	02→	CR9EB	6955			CR9EIX	3521	0.7
	NRG 50, NRG Power DD/DT Ø14mm Plug	97→	BR9ES	5722			BR9EIX	3981	0.6
	NRG mc3 Pure Jet Ø10mm Plug	02→05	CPR8E	7411			CR8EIX	4218	0.8
	NRG mc3 Pure Jet Ø10mm Plug	06→			ZMR7AP	6914			0.8
	PK50S	83→87	B6HS	4510			BR6HIX	3419	0.5
	Sfera 50	91→97	BR9ES	5722			BR9EIX	3981	0.5
	Typhoon 50	93→	B9ES	2611	B9EVX	7254	BR9EIX	3981	0.5
	Velofax, Quartz, Zip, Zip SP (2-Stroke)	93→	BR9ES	5722			BR9EIX	3981	0.5
	Vespa ET2 (2-Stroke)	97→05	BR9ES	5722			BR9EIX	3981	0.5
	Vespa ET4 50 (4-Stroke)	01→05	CR9EB	6955			CR9EIX	3521	0.6
	Vespa LX50 (2-Stroke)	05→	BR9ES	5722			BR9EIX	3981	0.6
	Vespa LX50 (4-Stroke) Ø10mm Plug	06→09	CR8EB	7784			CR8EIX	4218	0.8
	Vespa LX50 4V (4-Stroke) Ø8mm Plug	10→	ER9EH-6N	1673					0.6
	Vespa LXV 50 (2-Stroke)	06→	BR9ES	5722			BR9EIX	3981	0.6
	Vespa S 50 (2-Stroke) Ø14mm Plug	07→	BR9ES	5722			BR9EIX	3981	0.6
Vespa S 50 (4-Stroke) Ø8mm Plug	08→	ER9EH-6N	1673					0.6	
Zip 50 (2-Stroke)	93→	BR9ES	5722			BR9EIX	3981	0.7	
Zip 50 (4-Stroke)	02→	CR8EB	7784			CR8EIX	4218	0.7	
80	Sfera 80	93→98	BR9ES	5722			BR9EIX	3981	0.5
	Typhoon 80	94→00	B9ES	2611	B9EVX	7254	BR9EIX	3981	0.5
100	Diesis 100	02→03	BR9ES	5722			BR9EIX	3981	0.6
	Fly 100 (4-Stroke)	08→	CR8EB	7784			CR8EIX	4218	0.7
	PK 100 S	83→93	B6HS	4510			BR6HIX	3419	0.5
	Zip 100 (4-Stroke)	06→08	CR9EB	6955			CR9EIX	3521	0.7
125	Ape		BR7HS	4122			BR7HIX	7067	0.7
	B 125 Beverly (Liquid Cooled 4-Stroke)	02→	CR8EB	7784			CR8EIX	4218	0.8
	Carnaby 125	07→	CR8EB	7784			CR8EIX	4218	0.8
	Cosa, Cosa II (125)	90→95	BR9ES	5722			BR9EIX	3981	0.6
	Fly 125 (4-Stroke)	05→	CR7EB	4663			CR7EIX	7385	0.6
	Hexagon 125	94→98	BR9ES	5722			BR9EIX	3981	0.5
	Hexagon GTX 125	00→02	CR9EB	6955			CR9EIX	3521	0.7
	Hexagon LX 125	98→00	BR9ES	5722			BR9EIX	3981	0.6
	Liberty 125 (4-Stroke)	98→	CR9E	6263			CR9EIX	3521	0.6
	Liberty 125 Leader		CR8EB	7784			CR8EIX	4218	0.7
	MP3 125		CR8EB	7784			CR8EIX	4218	0.8
	P125X		B6HS	4510			BR6HIX	3419	0.5
	Primavera & PK 125		B6HS	4510			BR6HIX	3419	0.5
	Primavera ET3		B7HS	5110			BR7HIX	7067	0.5
	Sfera 125 (4-Stroke)	96→98	CR9E	6263			CR9EIX	3521	0.6
	Skipper	93→98	B9ES	2611	B9EVX	7254	BR9EIX	3981	0.5
	Skipper 125 (2-Stroke)	98→01	BR9ES	5722			BR9EIX	3981	0.5
	Skipper ST 125 (4-Stroke)	00→	CR7EB	4663			CR7EIX	7385	0.6
	Typhoon 125	95→03	B9ES	2611	B9EVX	7254	BR9EIX	3981	0.5
	Vespa 946	13→	CR8EB	7784			CR8EIX	4218	0.8
	Vespa ET4 125 (4-Stroke)	96→05	CR8EB	7784			CR8EIX	4218	0.8
	Vespa GT 125 Granturismo	03→07	CR8EB	7784			CR8EIX	4218	0.8
	Vespa GT V 125	06→	CR8EB	7784			CR8EIX	4218	0.8
	GTS 125	07→	CR8EB	7784			CR8EIX	4218	0.8
	GTS 125 Super i.e.	09→	CR8EKB	4374			CR8EIX	4218	0.7
	Vespa LX 125 (4-Stroke)	05→11	CR7EB	4663			CR7EIX	7385	0.6
	Vespa LX 125 3V (4-Stroke)	12→	CR8EB	7784			CR8EIX	4218	0.8
	Vespa LX V 125	06→	CR7EB	4663			CR7EIX	7385	0.6
	Vespa PX125E (Electric Start)	82→93	BR7HS	4122			BR7HIX	7067	0.5
	Vespa PX125T5, T5 Classic (2-Stroke)	85→99	B9ES	2611	B9EVX	7254	BR9EIX	3981	0.5
	Vespa PX125 (2-Stroke, Euro 1)	00→08	B6HS	4510			BR6HIX	3419	0.5
	Vespa S 125	07→	CR7EB	4663			CR7EIX	7385	0.6
	X7 125	2008	CR8EB	7784			CR8EIX	4218	0.6
X7 125	09→	CR8EKB	4374			CR8EIX	4218	0.7	
X8 125	06→08	CR8EB	7784			CR8EIX	4218	0.6	

2 Wheel



CC	MODEL	DATE	STANDARD COPPER CORE	STOCK NUMBER	PLATINUM OR GOLD PALLADIUM	STOCK NUMBER	IRIDIUM	STOCK NUMBER	GAP MM
PIAGGIO / VESPA (CONTINUED)									
125	X9 125 (Piaggio 4-Stroke)	01→	CR8EB	7784			CR8EIX	4218	0.6
	Xevo 125	07→	CR8EB	7784			CR8EIX	4218	0.7
	Zip 125	01→04	CR7EB	4663			CR7EIX	7385	0.6
150	Cosa 150		BR9ES	5722			BR9EIX	3981	0.6
	Vespa PX150	83→90	B6HS	4510			BR6HIX	3419	0.5
180	Hexagon 180LXT	98→00	BR9ES	5722			BR9EIX	3981	0.6
190	Ape		BR7HS	4122			BR7HIX	7067	0.7
200	Beverly 200 (4-Stroke)		CR8EB	7784			CR8EIX	4218	0.8
	Cosa 200, P200E		B6ES	7310					0.5
	Cosa II 200	88→91	B7ES	1111			BR7EIX	6664	0.5
	Vespa GT 200 Granturismo	03→07	CR7EB	4663			CR7EIX	7385	0.6
	Vespa PX200	86→97	B7ES	1111			BR7EIX	6664	0.5
	Vespa PX200 E Disc	98→	BR6ES	4922					0.6
	X8 200	05→	CR7EKB	4455			CR7EIX	7385	0.8
220	Ape		BR7HS	4122			BR7HIX	7067	0.7
250	Hexagon GT 250, GTX 250 (Honda 4-Stroke)	98→01	DPR6EA-9	5531					0.9
	Super Hexagon GTX250	00→	CR9E	6263			CR9EIX	3521	0.7
	Vespa GTS 250i.e.	05→	CR8EB	7784			CR8EIX	4218	0.6
	Vespa GTV 250i.e.	06→	CR8EB	7784			CR8EIX	4218	0.6
	X8 250	06→08	CR8EB	7784			CR8EIX	4218	0.6
	X9 250cc (Honda 4-Stroke)	00→	DPR7EA-9	5129	DPR7EVX-9	7682	DPR7EIX-9	7803	0.9
	X9 250cc Evolution (Quasar 4-Stroke + carb)		CR8EB	7784			CR8EIX	4218	0.6
300	MP3 300 (Incl. LT)	10→	CR8EKB	4374			CR8EIX	4218	0.7
	Vespa GTS 300	08→	CR8EKB	4374			CR8EIX	4218	0.7
350	Beverly 350 Sport Touring	12→	CR8EKB	4374			CR8EIX	4218	0.7
	X10	12→	CR7EKB	4455			CR7EIX	7385	0.8
400	MP3 400	07→	CR7EKB	4455			CR7EIX	7385	0.8
	X8 400	06→08	CR7EKB	4455			CR7EIX	7385	0.8
	Xevo 400	07→	CR7EKB	4455			CR7EIX	7385	0.8
460	B500	03→	CR7EKB	4455			CR7EIX	7385	0.8
	X9 500 (Fuel Injection 4-Stroke)	02→	CR7EKB	4455			CR7EIX	7385	0.8
	X9 500 Evolution (Fuel Injection 4-Stroke)	04→08	CR7EKB	4455			CR7EIX	7385	0.8

PIONEER									
125	Nevada 125	08→	D8EA	2120			DR8EIX	6681	0.7
	Torro 125	08→	D8EA	2120			DR8EIX	6681	0.7

PUCH									
50	Magnum		B-4H	4110					0.5
	Maxi: 1.0 HP Models		B-4H	4110					0.5
	Maxi: 1.5 HP Models		B5HS	4210					0.5
	Maxi: 2.0 HP Models		B6HS	4510			BR6HIX	3419	0.5
	Monza 50, Ranger 50, X40		B7HS	5110			BR7HIX	7067	0.5

PULSE									
50	HT50QT-36 Force 50 (2-valve)		CR7HS	7223			CR7HIX	7544	0.7
	Force 50 (2-Stroke)	08→	BPR7HS	6422			BPR7HIX	5944	0.6
	Force 50 (4-Stroke)	11→	CR7HS	7223			CR7HIX	7544	0.7
	Rhythm, Scout		CR7HS	7223			CR7HIX	7544	0.7
	Evo SM		BR8ES	5422			BR8EIX	5044	0.6
125	Adrenaline 125 XF125GY-2B		CR8E	1275			CR8EIX	4218	0.7
	HT125T-9 Vijo 125		D8EA	2120			DR8EIX	6681	0.7
	LK125GY-2 Rage 125		CR7HS	7223			CR7HIX	7544	0.7
	Zoom		CR7HSA	4549			CR7HIX	7544	0.6

REGAL RAPTOR									
50	DD50QE-2	03→	CR7HS	7223			CR7HIX	7544	0.7
100	DD100E	03→	CR7HS	7223			CR7HIX	7544	0.7



CC	MODEL	DATE	STANDARD COPPER CORE	STOCK NUMBER	PLATINUM OR GOLD PALLADIUM	STOCK NUMBER	IRIDIUM	STOCK NUMBER	GAP MM
REGENT									
125	Roadster, Deluxe, Sports Tourer, Super RT125		B7HS	5110			BR7HIX	7067	0.6
150	Roadster, Trail, Deluxe	95→97	B7HS	5110			BR7HIX	7067	0.6
175	Roadster, Trail, Deluxe, Sports Tourer, Super RT175	95→97	B7HS	5110			BR7HIX	7067	0.6

RIDERS									
50	Riders Super Cub	11→	CR7HSA	4549			CR7HIX	7544	0.6
110	Riders Super Cub	11→	CR7HSA	4549			CR7HIX	7544	0.6

RIEJU									
50	MRT 50 (Incl. Pro, SM)		BR9ES	5722			BR9EIX	3981	0.6
	MRX 50 (Minarelli engine)	03→	BR9ES	5722			BR9EIX	3981	0.8
	MRX 50 Pro	03→	BR9ES	5722			BR9EIX	3981	0.8
	MX50 (Morini S5 engine)	03→	B6HS	4510			BR6HIX	3419	0.5
	RR50 / Spike / Supermotard / RR50 Castrol	97→	BR9ES	5722			BR9EIX	3981	0.8
	RRX Spike 50 Supermoto	07→	BR8ES	5422			BR8EIX	5044	0.5
	RS1 Evolution	98→04	BR9ES	5722			BR9EIX	3981	0.8
	RS2 50 Matrix (Incl. Pro)	03→	BR9ES	5722			BR9EIX	3981	0.7
	RS2 50 NKD		BR9ES	5722			BR9EIX	3981	0.7
	RS3	11→	BR9ES	5722			BR9EIX	3981	0.7
	RS3 NKD	13→	BR9ES	5722			BR9EIX	3981	0.7
	SMX (Minarelli engine)	03→	BR9ES	5722			BR9EIX	3981	0.8
	SMX Pro 50	04→	BR9ES	5722			BR9EIX	3981	0.7
	Spike 50		BR9ES	5722			BR9EIX	3981	0.7
Tango 50, Tango0! 50	07→	BR9ES	5722			BR9EIX	3981	0.7	
125	Marathon (Endura / SM)		CR8E	1275			CR8EIX	4218	0.7
	MRX (Yamaha 4-Stroke)	03→	CR7HSA	4549			CR7HIX	7544	0.6
	RS2 125 Matrix	06→	CR7HSA	4549			CR7HIX	7544	0.6
	RS2 125 NKD	06→07	CR7HSA	4549			CR7HIX	7544	0.6
	RS2 125 Pro	07→11	CR7HSA	4549			CR7HIX	7544	0.6
	RS3	11→	CR8E	1275			CR8EIX	4218	0.7
	RS3 NKD	13→	CR8E	1275			CR8EIX	4218	0.7
	SMX (Yamaha 4-Stroke)	03→	CR7HSA	4549			CR7HIX	7544	0.6
Tango 125	07→	CR7HSA	4549			CR7HIX	7544	0.6	
250	Marathon	10→	CR8E	1275			CR8EIX	4218	0.7
	Tango 250		D8EA	2120			DR8EIX	6681	0.7
450	Marathon	10→	CR8E	1275			CR8EIX	4218	0.7

ROVIGO									
50	Spoletto 50, Tempesta 50	99→	BPR7HS	6422			BPR7HIX	5944	0.6

ROYAL ENFIELD (1980→)									
350	Bullet Classic models	80→	B7HS	5110			BR7HIX	7067	0.5
500	Bullet Classic models	80→08	BR8ES	5422			BR8EIX	5044	0.5
	Bullet Electra X Lean Burn engine models	04→08	BR9ES	5722			BR9EIX	3981	0.8

RTX									
125	Cross C125, Trials T125		B7HS	5110			BR7HIX	7067	0.6
212	Cross C212, Trials T212		B8HS	5510	B8HVX	2634	BR8HIX	7001	0.6

SACHS									
50	Dirty Devil	04→	BP5HS	4111					0.6
	MadAss 50	04→	CR7HSA	4549			CR7HIX	7544	0.6
	Speedjet R	05/09→	BPR7HS	6422			BPR7HIX	5944	0.7
	Speedjet RS	06/11→	BPR7HS	6422			BPR7HIX	5944	0.7
110	Dirty Devil	04→	C7HSA	4629			CR7HIX	7544	0.6

2 Wheel



CC	MODEL	DATE	STANDARD COPPER CORE	STOCK NUMBER	PLATINUM OR GOLD PALLADIUM	STOCK NUMBER	IRIDIUM	STOCK NUMBER	GAP MM
SACHS (CONTINUED)									
125	MadAss 125	06→	C7HSA	4629			CR7HIX	7544	0.6
	Roadster 125	00→05	CR6HSA	2983			CR6HIX	7274	0.8
	XTC 125, ZX Enduro 125, ZZ 125	00→	BR9ES	5722			BR9EIX	3981	0.8
650	Roadster 650	00→	CR10E	6264			CR10EIX	6482	0.8
805	B 805	02→	DPR8EA-9	4929			DPR8EIX-9	2202	0.9
	Roadster 800	00→05	DPR8EA-9	4929			DPR8EIX-9	2202	0.9

SCORPA									
70	4-Tricks	06→07	CR7HSA	4549			CR7HIX	7544	0.7
125	SR125R	11→	BP5ES	6511			BPR5EIX	6597	0.5
	SY 125 FR	03→09	CR7HSA	4549			CR7HIX	7544	0.7
	TY-S 125F	04→06	CR7HSA	4549			CR7HIX	7544	0.7
	TY 125F	12→	CR6HSA	2983			CR6HIX	7274	0.7
175	SY 175 F	03→09	CR7HSA	4549			CR7HIX	7544	0.7
	TY-S 175 F	03→09	CR7HSA	4549			CR7HIX	7544	0.7
250	SY 250						BPR6EIX	6637	0.7
	SY 250 FR	07→	CR8E	1275			CR8EIX	4218	0.7
	SY 250 Long Ride	06→09			BKR5EVX	2546	BKR5EIX	6341	0.6
	SY 250 Racing	01→09			BKR5EVX	2546	BKR5EIX	6341	0.6
	T-Ride 250F	08→	CR8E	1275			CR8EIX	4218	0.7
	TY 250 / E						BKR6EIX	6418	0.7
272	SR280R	11→	BP5ES	6511			BPR5EIX	6597	0.5
300	294, 295		BP5ES	6511			BPR5EIX	6597	0.5

SHERCO									
50	0.5 Kid	03→	B9ES	2611	B9EVX	7254	BR9EIX	3981	0.6
	Base		BR9ES	5722			BR9EIX	3981	0.7
	Champion Replica 50		BR9ES	5722			BR9EIX	3981	0.7
	Enduro 50	03→	BR9ES	5722			BR9EIX	3981	0.7
	HRD50	03→	BR9ES	5722			BR9EIX	3981	0.7
	Ipone Replica		BR9ES	5722			BR9EIX	3981	0.7
	Supermotard 50	03→	BR9ES	5722			BR9EIX	3981	0.7
80	ST 0.8	04→	BP5ES	6511			BPR5EIX	6597	0.5
125	Academy 125	2009	BP5ES	6511			BPR5EIX	6597	0.6
	City Corp 125	04→	CR7HSA	4549			CR7HIX	7544	0.6
	ST 1.25	99→	BP5ES	6511			BPR5EIX	6597	0.6
200	2.0	99→	BP5ES	6511			BPR5EIX	6597	0.6
250	2.5i-F	08→11	CR8EK	3478			CR8EIX	4218	0.7
	Access 2.5 (2-Stroke)	2010	BP5ES	6511			BPR5EIX	6597	0.6
	SE 250i	12→	CR8EK	3478			CR8EIX	4218	0.7
	ST 2.5	99→10	BP5ES	6511			BPR5EIX	6597	0.6
	ST 2.5	11→	BP5ES	6511			BPR5EIX	6597	0.6
290	3.0i-F	10→11	CR8EK	3478			CR8EIX	4218	0.7
	Access 2.9 (2-Stroke)	2010	BP5ES	6511			BPR5EIX	6597	0.6
	ST 2.9	99→10	BP5ES	6511			BPR5EIX	6597	0.6
	ST 2.9	11→	BP5ES	6511			BPR5EIX	6597	0.6
	SE 300i	12→	CR8EK	3478			CR8EIX	4218	0.7
320	3.2 4T	05→			PFR6B	3500		0.6	
450	4.5i-F 4T	04→	CR8EK	3478			CR8EIX	4218	0.7
	4.5i Enduro	05→	CR8EK	3478			CR8EIX	4218	0.7
510	5.1i	05→	CR8EK	3478			CR8EIX	4218	0.7

SIMSON									
50	S51 Series SR50		B7HS	5110			BR7HIX	7067	0.5
70	S70 C&E	83→	B7HS	5110			BR7HIX	7067	0.5



CC	MODEL	DATE	STANDARD COPPER CORE	STOCK NUMBER	PLATINUM OR GOLD PALLADIUM	STOCK NUMBER	IRIDIUM	STOCK NUMBER	GAP MM
SINNIS									
50	Eagle, Hawk (2-Stroke)	06/06→	BPR7HS	6422			BPR7HIX	5944	0.6
	Falcon, Jet (4-Stroke)	06/06→	CR7HSA	4549			CR7HIX	7544	0.6
	Flair	05/12→	CR7HSA	4549			CR7HIX	7544	0.6
	Ghost, Nitro, Pioneer, Strike (2-Stroke)	06/06→09	BPR7HS	6422			BPR7HIX	5944	0.6
	Phoenix	05/12→	BPR7HS	6422			BPR7HIX	5944	0.6
110	Breeze	06/06→09	CR7HSA	4549			CR7HIX	7544	0.6
125	Apache, Blade, Max, Stealth, Vista	12/07→	CR8E	1275			CR8EIX	4218	0.7
	Eagle, Matrix, Matrix II, Nitro, Pioneer, Sublime (4-Stroke)	01/07→	CR7HSA	4549			CR7HIX	7544	0.6
	Eco City	01/10→	CR7HSA	4549			CR7HIX	7544	0.6
	Spirit	05/12→	CR7HSA	4549			CR7HIX	7544	0.6
	Trackstar	05/10→	CR8E	1275			CR8EIX	4218	0.7
200	Apache, Blade	12/07→09	DR8ES-L	2923	DR8EVX	6354	DR8EIX	6681	0.7

SKYTEAM									
125	Wacky ST125/Y		C7HSA	4629			CR7HIX	7544	0.7

SMC									
50	NAF 50 Navigator		BPR7HS	6422			BPR7HIX	5944	0.6
	NGF 50 Sports Force		BPR7HS	6422			BPR7HIX	5944	0.6
	NKF 50 on/off road		BPR7HS	6422			BPR7HIX	5944	0.6
	NLFR 50 Caprillio		BPR7HS	6422			BPR7HIX	5944	0.6
	PAF 50 Partner		BPR7HS	6422			BPR7HIX	5944	0.6
	SBF 50 Super		BPR7HS	6422			BPR7HIX	5944	0.6
90	NGN 90 Sports Force		BPR7HS	6422			BPR7HIX	5944	0.6
	SBN 90 Super		BPR7HS	6422			BPR7HIX	5944	0.6
100	NKO 100 on/off road		BPR7HS	6422			BPR7HIX	5944	0.6
	SBO 100 Super		BPR7HS	6422			BPR7HIX	5944	0.6
125	CHP 125 Chopper		DR8EA	7162	DR8EVX	6354	DR8EIX	6681	0.7

SUPERBYKE									
50	M-PED 50	06→	CR7HSA	4549			CR7HIX	7544	0.6
	Powerband 50 (2-Stroke) Ø14mm Plug	06→	BPR7HS	6422			BPR7HIX	5944	0.6
	Powermax 50 (2-Stroke) Ø14mm Plug	08→	BPR7HS	6422			BPR7HIX	5944	0.6
125	Powerband 125	06→	CR7HSA	4549			CR7HIX	7544	0.6
	RBP125	06→	D8EA	2120			DR8EIX	6681	0.7
	RMR125		CR8E	1275			CR8EIX	4218	0.7
	SMax125	08→	CR7HSA	4549			CR7HIX	7544	0.6

SUZUKI									
50	AE50 L, M, N, P, R, T	90→99	BPR6HS	7022			BPR6HIX	4085	0.6
	AH50	93→96	BPR6HS	7022			BPR6HIX	4085	0.6
	AP50 T, V, W	96→02	BPR6HS	7022			BPR6HIX	4085	0.7
	AY50 Katana/Sport W, Y, WRX, WRY, WR K1-K4		BPR6HS	7022			BPR6HIX	4085	0.8
	AY50-W K4		BPR6HS	7022			BPR6HIX	4085	0.8
	AY50A K5	05→	CPR8E	7411			CR8EIX	4218	0.8
	CL50D, CS50D, FS50 Snip		BPR4HS	7823					0.7
	CP50	85→92	BPR6HS	7022			BPR6HIX	4085	0.6
	DR50		BR7HS	4122			BR7HIX	7067	0.6
	FR50	81→86	BPR4HS	7823					0.7
	FZ50 Suzy	80→86	BPR4HS	7823					0.7
	JR50 K4		BPR4HS	7823					0.7
	RM50-C/N/T/X/Z		B7HS	5110			BR7HIX	7067	0.6
	RMX 50		BPR8ES	3923			BPR8EIX	6684	0.7
	SMX 50		BPR8ES	3923			BPR8EIX	6684	0.7
	TR50S	97→00	BPR6HS	7022			BPR6HIX	4085	0.6
	TS50 X/ER/XKE-G-H-J-M-R	84→	BPR6ES	7822			BPR6EIX	6637	0.7
	TS50 /ER/K/N		BP6HS	4511			BPR6HIX	4085	0.7
	UF 50 Estilete	99→01	BPR7HS	6422			BPR7HIX	5944	0.6
	UX50W-X-Y Zillion	99→01	BPR6HS	7022			BPR6HIX	4085	0.6
	ZR50-L/X1/SKE	83→	BP6ES	7811	BP6EVX	5832	BPR6EIX	6637	0.7



CC	MODEL	DATE	STANDARD COPPER CORE	STOCK NUMBER	PLATINUM OR GOLD PALLADIUM	STOCK NUMBER	IRIDIUM	STOCK NUMBER	GAP MM	
SUZUKI (CONTINUED)										
65	RM65 K3-K5		B10EG	3630	B10EGV	5927	BR10EIX	6801	0.6	
70	DR-Z70	08→	CR7HSA	4549			CR7HIX	7544	0.6	
80	CP80	85→94	BPR6HS	7022			BPR6HIX	4085	0.7	
	CS80CD	83→87	BPR6HS	7022			BPR6HIX	4085	0.7	
	FR80D	84→87	BPR6HS	7022			BPR6HIX	4085	0.7	
	RM80T		B10EG	3630	B10EGV	5927	BR10EIX	6801	0.6	
	RM80X G, H, J, K, L		B9EG	3530	B9EGV	5827	BR9EIX	3981	0.7	
	RM80X M, N, P, R, S, T, V		B10EG	3630	B10EGV	5927	BR10EIX	6801	0.7	
	RM80 K1	00→	BR10ES	4832			BR10EIX	6801	0.8	
85	RM85 /L K3-K5	03→	BR10ES	4832			BR10EIX	6801	0.8	
100	AH100	94→97	BPR7HS	6422			BPR7HIX	5944	0.6	
	GP100 All models	78→92	B8HS	5510	B8HVX	2634	BR8HIX	7001	0.7	
	RM100 K4	04→	R625K-105	2741					0.7	
	TS100ER, TS100ERZ	78→89	B8ES	2411			BR8EIX	5044	0.7	
110	UG 110 Hokuto	99→02	BPR7HS	6422			BPR7HIX	5944	0.6	
125	Address 125	07→	CR8E	1275			CR8EIX	4218	0.7	
	AN125 S	95→96	CR8E	1275			CR8EIX	4218	0.6	
	AN125 T,V,W	96→11/98	CR7E	4578			CR7EIX	7385	0.6	
	AN125 X	11/98→	CR8E	1275			CR8EIX	4218	0.7	
	CS125D	83→87	D8EA	2120	DR8EVX	6354	DR8EIX	6681	0.7	
	DR125 SEX-SEY	99→01	DR8EA	7162	DR8EVX	6354	DR8EIX	6681	0.7	
	DR125S D/F/H/J	82→94	DR8ES-L	2923	DR8EVX	6354	DR8EIX	6681	0.7	
	DR125SM	08→	CR8E	1275			CR8EIX	4218	0.7	
	DRZ125	10→	DR8EA	7162	DR8EVX	6354	DR8EIX	6681	0.7	
	GN125 W-X	93→01	DR8EA	7162	DR8EVX	6354	DR8EIX	6681	0.7	
	GP125 All models	78→89	B8HS	5510	B8HVX	2634	BR8HIX	7001	0.7	
	GS125ES, D All models		DR8ES-L	2923	DR8EVX	6354	DR8EIX	6681	0.7	
	GT125		B8HS	5510	B8HVX	2634	BR8HIX	7001	0.7	
	GZ125 W, X, Y, K1-K3 Marauder	98→	DR8EA	7162	DR8EVX	6354	DR8EIX	6681	0.6	
	GZ125 K4-K5	04→	CR8E	1275			CR8EIX	4218	0.7	
	RG125 UC, G, H, J, J2	85→94	BR8ES	5422			BR8EIX	5044	0.6	
	RG125FU-N, P, R	91→95	BR9ECM	3252	BR9ECMVX	2434			0.7	
	RG125U Wolf	91→95	BR9ECM	3252	BR9ECMVX	2434			0.6	
	RM125 E, F, G, H, J		BR9EG	3230			BR9EIX	3981	0.5	
	RM125 K, L, M		B9EG	3530	B9EGV	5827	BR9EIX	3981	0.5	
	RM125 N, R, S				R4118S-9	3245			0.6	
	RM125 T, V, W, K1-K8				R6918B-8	4492			0.6	
	RV125 Van Van K4-K5	03→	CR8E	1275			CR8EIX	4218	0.7	
	TS125 (A/B)		B8HS	5510	B8HVX	2634	BR8HIX	7001	0.7	
	TS125 (C,ER/X/Z/D/XUE/XE)		B8ES	2411			BR8EIX	5044	0.7	
	TS125R K, L, M, N, P, R	90→96	BR9ES	5722			BR9EIX	3981	0.7	
	UC125 X Epicuro	99→02	CR8E	1275			CR8EIX	4218	0.7	
	UH125 K2-K9 Burgman	02→	CR8E	1275			CR8EIX	4218	0.7	
	UX125 Sixteen 125	07→	CR8E	1275			CR8EIX	4218	0.7	
	VL125 Y, K1-K5 Intruder	99→08	CR8E	1275			CR8EIX	4218	0.7	
	200	AN200 K7 Burgman	07→	CR8EK	3478			CR8EIX	4218	0.7
		DR200S		DR8ES-L	2923	DR8EVX	6354	DR8EIX	6681	0.6
		GT200X5		B8ES	2411			BR8EIX	5044	0.7
SB200		79→83	B8ES	2411			BR8EIX	5044	0.7	
250		AN250 W, X, Y, K1-K3 Burgman	→03	CR8EK	3478			CR8EIX	4218	0.7
AN250 K4-K5 Burgman	04→	CR7EK	7546			CR7EIX	7385	0.7		
GN250 F, J, K, L, M, N, P, R, T	87→97	DR8EA	7162	DR8EVX	6354	DR8EIX	6681	0.6		
GS250T, T/X	80→84	DR8ES	5423	DR9EVX	6361	DR9EIX	4772	0.7		
GSX250E T, X, Z	80→85	DR8ES	5423	DR9EVX	6361	DR9EIX	4772	0.7		
GT250A/B/C (½", 12.7mm Thread Reach)		B8HS	5510	B8HVX	2634	BR8HIX	7001	0.7		
GT250A/B/C (¾", 19mm Thread Reach)		B9ES	2611	B9EVX	7254	BR9EIX	3981	0.7		
GT250K, L, M		B8ES	2411			BR8EIX	5044	0.7		
GT250X7 EN/EX	78→83	B9ES	2611	B9EVX	7254	BR9EIX	3981	0.7		
GW250 L2 Inazuma	12→	CR7E	4578			CR7EIX	7385	0.7		
PE250 B/C		B8EG	3430	B8EGV	5627	BR8EIX	5044	0.5		
PE250 N/T/X/Z		BR10EG	3830			BR10EIX	6801	0.6		
RG250 Gamma	83→89	BR9ES	5722			BR9EIX	3981	0.7		
RGV250K, L	89→90	BR9ES	5722			BR9EIX	3981	0.7		
RGV250M, N, P, R	90→97	BR9ECM	3252	BR9ECMVX	2434			0.6		



CC	MODEL	DATE	STANDARD COPPER CORE	STOCK NUMBER	PLATINUM OR GOLD PALLADIUM	STOCK NUMBER	IRIDIUM	STOCK NUMBER	GAP MM
SUZUKI (CONTINUED)									
250	RM250 E, F, G, H, J, K, L, M		B8EG	3430	B8EGV	5627	BR8EIX	5044	0.5
	RM250 N, P, R, S	92→95			R4118S-8	3236			0.6
	RM250T, V, W	96→99			R6918B-7	6259			0.6
	RM250 K1-K5	01→05	BR8EG	3130			BR8EIX	5044	0.6
	RM250Z/D		B8EG	3430	B8EGV	5627	BR8EIX	5044	0.5
	RMX250K, L, M, N, S	89→95			B8EGV	5627	BR8EIX	5044	0.5
	RMX250RP						BR9EIX	3981	0.5
	RMX250T						BR9EIX	3981	0.5
	RM-Z250 K4-K5 (4-Stroke)	04→06	CR8EB	7784			CR8EIX	4218	0.7
	RM-Z250 K7-L3 (4-Stroke)	07→					CR8EIA-10	4708	1.0
	TS250 X	85→89	BR8ES	5422			BR8EIX	5044	0.6
	TS250ER N/T/X	79→83	BP7ES	2412	BP7EVX	7270	BPR7EIX	4055	0.7
	TU250 X, V, W	97→00	DR8EA	7162	DR8EVX	6354	DR8EIX	6681	0.6
350	DR350S L, M, N, P	91→	DPR9EA-9	5329			DPR9EIX-9	5545	0.9
	DR350SE S, V, W, X	95→99	CR9EK	4548			CR9EIX	3521	0.7
	DR350-S-R	94→	CR9EK	4548			CR9EIX	3521	0.7
380	GT380	72→78	B8ES	2411			BR8EIX	5044	0.7
400	AN400 X, Y, K1-K6 Burgman	99→07	CR7E	4578			CR7EIX	7385	0.7
	AN400 K7-K8 Burgman	10/07→	CR7E	4578			CR7EIX	7385	0.7
	DR400	80→82	DR8ES-L	2923	DR8EVX	6354	DR8EIX	6681	0.7
	DR-Z400E Y, K1-K5, DR-Z400S Y, K1-K5	99→07	CR8E	1275			CR8EIX	4218	0.7
	DR-Z400SM K5-K7	05→07	CR8E	1275			CR8EIX	4218	0.7
	GN400T	80→82	DR8ES-L	2923	DR8EVX	6354	DR8EIX	6681	0.7
	GS400, B/C		B8ES	2411			BR8EIX	5044	0.7
	GSF400M/N	91→	CR8EK	3478			CR8EIX	4218	0.7
	GSF400P-R	93→95	CR9EK	4548			CR9EIX	3521	0.7
	GSX400E T/X, GSX400F, X/Z/D	80→	DR8ES-L	2923	DR8EVX	6354	DR8EIX	6681	0.7
	GSX-R400H	86→	C8HSA	6821	CR8HVX	7236	CR8HIX	7669	0.6
	PE400T/X/Z		BR9EG	3230			BR9EIX	3981	0.7
	SP400	80→82	DR8ES-L	2923	DR8EVX	6354	DR8EIX	6681	0.7
450	GS450	85→	B8ES	2411			BR8EIX	5044	0.7
	RMX450Z L0	10→					CR8EIB-10	4948	1.0
	RM-Z450 K4-K6 (4-Stroke)	04→06					CR8EIB-10	4948	1.0
	RM-Z450/Z K7-L3 (4-Stroke)	07→					DIMR8A10	5066	1.0
500	GS500E K, L, M, N, P, R, S, T, V, W, X, Y, K1-K3	89→05	DPR8EA-9	4929			DPR8EIX-9	2202	0.9
	GS500E / F K4-K9	04→09	DPR8EA-9	4929			DPR8EIX-9	2202	0.9
	GT500	75→77	B7HS	5110			BR7HIX	7067	0.6
	RG500 Gamma	85→89	BR9ES	5722			BR9EIX	3981	0.6
	RM500D	83→85	B8EG	3430	B8EGV	5627	BR8EIX	5044	0.6
	T500	68→75	B8HS	5510	B8HVX	2634	BR8HIX	7001	0.6
550	GS550 All models	77→85	B8ES	2411			BR8EIX	5044	0.7
	GSX550 EE/ESD/ESE/EFE	83→88	DR8ES	5423	DR9EVX	6361	DR9EIX	4772	0.7
600	GSF600 S, T, V, W, Y, K1-K4 Bandit Naked (Unfaired)	95→05	CR9EK	4548			CR9EIX	3521	0.7
	GSF600S T, V, W, Y, K1-K4 Bandit (Faired)	95→05	CR9EK	4548			CR9EIX	3521	0.7
	GSR600/S K6-K9	06→	CR9E	6263			CR9EIX	3521	0.7
	GSX600F J, K, L, M, N, P, R, S, V	88→97	DR8ES	5423	DR9EVX	6361	DR9EIX	4772	0.7
	GSX600F T, V, W, X, Y, K1-K4	97→04	CR9EK	4548			CR9EIX	3521	0.7
	GSX-R600 V, W, X, K1-K7	97→07	CR9E	6263			CR9EIX	3521	0.6
	GSX-R600 K8-L1	08→					CR9EIA-9	6289	0.9
	RF600R P/R/S/V	93→97	CR9E	6263			CR9EIX	3521	0.7
	VS600 GLS	95→97	DPR8EA-9	4929			DPR8EIX-9	2202	0.9
650	AN650 K3-K5 Burgman		CR8E	1275			CR8EIX	4218	0.7
	AN650A K4-K9, AL1-L2 Burgman	04→	CR8E	1275			CR8EIX	4218	0.7
	DL650 K4-K5 V-Strom	03→	CR8E	1275			CR8EIX	4218	0.7
	DL650A V-Strom XP	2010	CR8E	1275			CR8EIX	4218	0.7
	DL650AL1 V-Strom 650 ABS	2011	CR8E	1275			CR8EIX	4218	0.7
	DL650AL2 V-Strom 650 ABS	12→					CR8EIA-9	4286	0.9
	DR650RSE Models and RE models	91→95	DPR9EA-9	5329			DPR9EIX-9	5545	0.9
	DR650SET	95→97	CR10E	6264			CR10EIX	6482	0.7
	GS650 All models (Incl. Katana)	81→	DR8ES-L	2923	DR8EVX	6354	DR8EIX	6681	0.7
	GSF650 K5, K6 Bandit	05→06	CR8EK	3478			CR8EIX	4218	0.7
	GSF650 K7-L0 Bandit (Liquid Cooled)	07→	CR9E	6263			CR9EIX	3521	0.6
	GSX650F	08→	CR8E	1275			CR8EIX	4218	0.7
	LS650 All models	87→98	DPR8EA-9	4929			DPR8EIX-9	2202	0.9



CC	MODEL	DATE	STANDARD COPPER CORE	STOCK NUMBER	PLATINUM OR GOLD PALLADIUM	STOCK NUMBER	IRIDIUM	STOCK NUMBER	GAP MM
SUZUKI (CONTINUED)									
650	SFV650 Gladius	09→					CR8EIA-9	4286	0.9
	SV650, SV650S X/Y/K1-K8	99→08	CR8E	1275			CR8EIX	4218	0.7
	XF650 V-W-X-Y Freewind	97→02	CR10E	6264			CR10EIX	6482	0.7
670	XN85 650 Turbo	83→86	DR8ES	5423	DR9EVX	6361	DR9EIX	4772	0.7
750	DR750 SJ/SK	88→90	DPR9EA-9	5329			DPR9EIX-9	5545	0.9
	GSR750	11→					CR9EIA-9	6289	0.9
	GSX750-W/X/Y/K1	97→	CR9EK	4548			CR9EIX	3521	0.7
	GSX750E T/EX/ESD/ESE/ESF/ESG	83→89	DR8ES-L	2923	DR8EVX	6354	DR8EIX	6681	0.7
	GSX750F K/L/M/N/P/R/S/T	89→96	JR9C	6193					0.7
	GSX750F W, X, Y, K1-K5	97→05	CR9EK	4548			CR9EIX	3521	0.7
	GSX-R750 F, G, H	85→88	DR8ES	5423	DR9EVX	6361	DR9EIX	4772	0.7
	GSX-R750 J, K	88→89	JR9C	6193					0.7
	GSX-R750 L, M	89→92	CR10EK	2360			CR10EIX	6482	0.7
	GSX-R750 WN, WP, WR, WS	91→96	CR9E	6263			CR9EIX	3521	0.7
	GSX-R750 T, V, W, X, Y, K1-K7	96→07	CR9E	6263			CR9EIX	3521	0.7
	GSX-R750 K8-L1	08→					CR9EIA-9	6289	0.9
	VS750GLP F, G, H, J, K, L, M	85→91	DPR8EA-9	4929			DPR8EIX-9	2202	0.9
800	DR800 SL, SM	90→92	DPR9EA-9	5329			DPR9EIX-9	5545	0.9
	VL800 K1-K5	01→05	DPR7EA-9	5129			DPR7EIX-9	7803	0.9
	VL800 K6 C800 Intruder	06→09	DPR7EA-9	5129			DPR7EIX-9	7803	0.9
	VL800 L0 Intruder C800	10→	DR7EA	7839					0.7
	VS800GL M, P, R, S, T, V	91→97	DPR8EA-9	4929			DPR8EIX-9	2202	0.9
	VX800 L/M/R	90→96	DPR8EA-9	4929			DPR8EIX-9	2202	0.9
	VZ800 V, W, X, Y, K1 Marauder	97→01	DPR8EA-9	4929			DPR8EIX-9	2202	0.9
	VZ800 K5→ Intruder M800	05→09	DPR7EA-9	5129			DPR7EIX-9	7803	0.9
	VZ800 L0 Intruder M800	10→	DR7EA	7839					0.7
	850	GS850 GN/GT/GX/GZ/GD/GE/GG	79→88	B8ES	2411			BR8EIX	5044
900	RF900R R, S, T, V, W	94→99	CR9E	6263			CR9EIX	3521	0.7
1000	DL1000 K2-K4 V-Strom	02→	CR8EK	3478			CR8EIX	4218	0.7
	GS1000 EC/EN/ET/GT/GX/SN	80→	B8ES	2411			BR8EIX	5044	0.7
	GSX1000 SZ/SD	81→85	DR8ES-L	2923	DR8EVX	6354	DR8EIX	6681	0.7
	GSX-R1000 K1-K6	00→06	CR9E	6263			CR9EIX	3521	0.7
	GSX-R1000 K6 Phantom	06→	CR9E	6263			CR9EIX	3521	0.7
	GSX-R1000 K7-L2	07→					CR9EIA-9	6289	0.9
	SV1000/S K3-K5	03→05	CR8EK	3478			CR8EIX	4218	0.7
	SV1000 Classic	07→08	CR8EK	3478			CR8EIX	4218	0.7
	TL1000R W, Y, K1-K3	98→03	CR9EK	4548			CR9EIX	3521	0.7
	TL1000S V, W, X, Y	97→01	CR8EK	3478			CR8EIX	4218	0.7
1100	GS1100GZ		B8ES	2411			BR8EIX	5044	0.7
	GSX1100 ET/X/Z/S/ESD,SZ,SD (Katana)	79→85	DR8ES-L	2923	DR8EVX	6354	DR8EIX	6681	0.7
	GSX1100 EFE/EF/EFF/EG/EFG	84→88	DR8ES	5423	DR9EVX	6361	DR9EIX	4772	0.7
	GSX1100 FJ, FK, FL, FM, FN, FP, FR, FS	87→96	JR9B	3188	DR9EVX	6361	DR9EIX	4772	0.6
	GSX1100 GM, GN, GP, GR	91→94	JR9B	3188	DR9EVX	6361	DR9EIX	4772	0.6
	GSX-R1100 G, H, J	86→89	JR9B	3188	DR9EVX	6361	DR9EIX	4772	0.6
	GSX-R1100 K, L, M, N	89→93	JR9B	3188	DR9EVX	6361	DR9EIX	4772	0.6
	GSX-R1100 W-P, R, S, T	93→96	CR9E	6263			CR9EIX	3521	0.7
1200	GSF1200S T, V, W, X, Y, K1-K6 Bandit (Faired)	96→	JR9B	3188	DR9EVX	6361	DR9EIX	4772	0.6
	GSF1200 T, V, W, X, Y, K1-K6 Bandit Naked (Unfaired)	96→	JR9B	3188	DR9EVX	6361	DR9EIX	4772	0.6
1250	GSF1250/SA K7 Bandit	07→	CR7E	4578			CR7EIX	7385	0.8
1255	GSX1250FA Bandit	10→	CR7E	4578			CR7EIX	7385	0.7
1300	GSX1300 B-King	07→					CR9EIA-9	6289	0.9
	GSX1300R X, Y, K1-K5 Hayabusa	99→07	CR9E	6263			CR9EIX	3521	0.7
1340	GSX1300R Hayabusa	08→					CR9EIA-9	6289	0.9
1400	GSX1400 K2-K4	01→	CR8EK	3478			CR8EIX	4218	0.7
	VS1400GLP-H, J, R, S, T, V, W (Intruder)	87→99	DPR8EA-9	4929			DPR8EIX-9	2202	0.9
1500	C1500T Intruder	13→	CPR6EA-9	6899					0.9
	VL1500 LC/X	98→03	DPR7EA-9	5129			DPR7EIX-9	7803	0.9
	VL1500 →K5	→05	DPR7EA-9	5129			DPR7EIX-9	7803	0.9
	VZ1500 L0 Intruder M1500	10→	CR6E	6965					0.7
1600	VZ1600 K4-K5	03→04	DPR6EA-9	5531					0.9
1800	VLR1800 C1800R/RT Intruder	08→	CR8EK	3478			CR8EIX	4218	0.7
	VZR1800 K6 M1800R Intruder	06→	CR8EK	3478			CR8EIX	4218	0.7



CC	MODEL	DATE	STANDARD COPPER CORE	STOCK NUMBER	PLATINUM OR GOLD PALLADIUM	STOCK NUMBER	IRIDIUM	STOCK NUMBER	GAP MM
SWM									
125	125TLM	77→84	BP5ES	6511			BPR5EIX	6597	0.4
200	TL200	→84	BP5ES	6511			BPR5EIX	6597	0.4
240	TL240	82→84	BP5ES	6511			BPR5EIX	6597	0.4
320	320TLM	77→84	BP5ES	6511			BPR5EIX	6597	0.4
350	TL350	83→84	BP5ES	6511			BPR5EIX	6597	0.4

SYM									
50	City Hopper	98→03	BR8HSA	5539			BPR8HIX	6742	0.6
	DD50 City Trek / Sport	02→	BR8HSA	5539			BPR8HIX	6742	0.6
	Fiddle	98→	BR8HSA	5539			BPR8HIX	6742	0.6
	Fiddle II 50	08→	BR8HSA	5539			BPR8HIX	6742	0.7
	Jet 50	98→	BR8HSA	5539			BPR8HIX	6742	0.6
	Jet 50 Sport X S/SE/SR/XS	06→	BR8HSA	5539			BPR8HIX	6742	0.7
	Jungle	98→02	BR8HSA	5539			BPR8HIX	6742	0.6
	Mask	98→	BR8HSA	5539			BPR8HIX	6742	0.6
	Mio 50	06→	CR6HSA	2983			CR6HIX	7274	0.7
	Red Devil	98→	BR8HSA	5539			BPR8HIX	6742	0.6
	Simply 50	08→	CR7HSA	4549			CR7HIX	7544	0.7
	Super Fancy	98→03	BR8HSA	5539			BPR8HIX	6742	0.6
100	Jet 100	99→	BR8HSA	5539			BPR8HIX	6742	0.6
	Jet 100 Sport X S/SR Jet		BR8HSA	5539			BPR8HIX	6742	0.6
	Mio 100		CR6HSA	2983			CR6HIX	7274	0.7
125	Attila, Super Duke	98→00	CR7HSA	4549			CR7HIX	7544	0.6
	Euro MX 125	05→	CR8E	1275			CR8EIX	4218	0.7
	Fiddle II 125	08→	CR7HSA	4549			CR7HIX	7544	0.6
	GTS Voyager 125	05→	CR8E	1275			CR8EIX	4218	0.8
	HD Orbit 125	04→	CR8E	1275			CR8EIX	4218	0.7
	Husky	98→	DR8EA	7162	DR8EVX	6354	DR8EIX	6681	0.6
	Joyride 125 (12.7mm Thread Reach)	02→04	CR7HSA	4549			CR7HIX	7544	0.6
	Joyride 125 (19mm Thread Reach)	05→	CR8E	1275			CR8EIX	4218	0.7
	Megalo 125	01→	CR7HSA	4549			CR7HIX	7544	0.6
	Shark 125 / R	99→05	CR8E	1275			CR8EIX	4218	0.8
	Simply 125	08→	CR7HSA	4549			CR7HIX	7544	0.7
	Voyager 125		CR8E	1275			CR8EIX	4218	0.7
	VS 125	06→	CR8E	1275			CR8EIX	4218	0.7
	Wolf 125		DR7EA	7839					0.7
XS 125		DR7EA	7839					0.7	
180	HD Orbit 180	04→	CR8E	1275			CR8EIX	4218	0.7
	Joyride 180	02→	CR8E	1275			CR8EIX	4218	0.7
200	HD Orbit 200		CR8E	1275			CR8EIX	4218	0.7
	Joyride 200		CR8E	1275			CR8EIX	4218	0.7
250	GTS Voyager 250	05→	CR8E	1275			CR8EIX	4218	0.7
300	Citycom 300	08→	CR8E	1275			CR8EIX	4218	0.7
	GTS 300		CR8E	1275			CR8EIX	4218	0.7
500	500 GT/XP	04→	CR7EKB	4455			CR7EIX	7385	0.8

TGB									
50	202 Classic	02→	BPR7HS	6422			BPR7HIX	5944	0.5
	302 Sport	02→	BPR7HS	6422			BPR7HIX	5944	0.5
	303R Hawk	04→	BPR7HS	6422			BPR7HIX	5944	0.5
	AKROStec	03→05	BPR7HS	6422			BPR7HIX	5944	0.5
	Delivery 50	03→	BPR7HS	6422			BPR7HIX	5944	0.5
	R50X	05→	BPR7HS	6422			BPR7HIX	5944	0.5
125	204 Classic	02→07	CR7HSA	4549			CR7HIX	7544	0.7
	303R Hawk	07→	CR7HSA	4549			CR7HIX	7544	0.7
	304 Sport	02→	CR7HSA	4549			CR7HIX	7544	0.7
	404 Executive	02→07	CR7HSA	4549			CR7HIX	7544	0.7
	Delivery 125	05→	CR7HSA	4549			CR7HIX	7544	0.7
	R125X	08→	CR7HSA	4549			CR7HIX	7544	0.7



CC	MODEL	DATE	STANDARD COPPER CORE	STOCK NUMBER	PLATINUM OR GOLD PALLADIUM	STOCK NUMBER	IRIDIUM	STOCK NUMBER	GAP MM
TOMOS									
50	A3/A5K	84→96	B6HS	4510			BR6HIX	3419	0.5
	AT50, ATX50, NTX50	86→91	B6HS	4510			BR6HIX	3419	0.5

TRIUMPH PRE-1989									
250-500	Twins with 3/4", 19mm Thread Reach		B8ES	2411			BR8EIX	5044	0.6
650	T120, R, V Bonneville	→68	B7ES	1111			BR7EIX	6664	0.6
	T120, R, V Bonneville	68→74	B8ES	2411			BR8EIX	5044	0.6
	TR6 (12.7mm Thread Reach)	56→60	B7HS	5110			BR7HIX	7067	0.6
	TR6 Thunderbird/Daytona	67→73	B6ES	7310					0.6
	TR6C Trophy (19mm Thread Reach)	67→73	B8ES	2411			BR8EIX	5044	0.6
	TR65 Thunderbird	81→83	B6ES	7310					0.6
750	T140E, T140D Bonneville, TSX4	78→	B6ES	7310					0.6
	T140V Bonneville	73→88	B8ES	2411			BR8EIX	5044	0.6
	T150/160 Trident (Incl. BSA, A75 and Rocket 3)	→75	B8ES	2411			BR8EIX	5044	0.6
	TR7T Tiger Trail	81→82	B6ES	7310					0.6
	TSX8, TSS		C8E	7471			CR8EIX	4218	0.6

TRIUMPH 1991-ON									
600	Daytona 600	03→04	CR9EK	4548			CR9EIX	3521	0.7
	TT 600	99→03	CR9EK	4548			CR9EIX	3521	0.7
	Speed Four	02→	CR9EK	4548			CR9EIX	3521	0.7
650	Daytona 650	04→05	CR9EK	4548			CR9EIX	3521	0.7
675	Daytona 675 Triple	05→08	CR9EK	4548			CR9EIX	3521	0.7
	Daytona 675 Triple	12/08→12	CR9EK	4548			CR9EIX	3521	0.7
	Daytona 675 (Incl R)	13→					CR9EIA-9	6289	0.9
	Street Triple	07→	CR9EK	4548			CR9EIX	3521	0.7
	Street Triple R	08→	CR9EK	4548			CR9EIX	3521	0.7
750	Trident, Daytona	91→98	DPR8EA-9	4929			DPR8EIX-9	2202	0.9
790	America	04→06	DPR8EA-9	4929			DPR8EIX-9	2202	0.9
	Bonneville (Incl. Black)	00→06	DPR8EA-9	4929			DPR8EIX-9	2202	0.9
	Bonneville America	01→06	DPR8EA-9	4929			DPR8EIX-9	2202	0.9
	Bonneville T100	02→04	DPR8EA-9	4929			DPR8EIX-9	2202	0.9
	Speedmaster	02→	DPR8EA-9	4929			DPR8EIX-9	2202	0.9
799	Tiger 800, Tiger 800 XC (Incl. ABS)	11→	CR9EK	4548			CR9EIX	3521	0.7
865	America 900	06→	DPR8EA-9	4929			DPR8EIX-9	2202	0.9
	Bonneville 900 (Incl. Black)	06→	DPR8EA-9	4929			DPR8EIX-9	2202	0.9
	Bonneville SE	12/08→	DPR8EA-9	4929			DPR8EIX-9	2202	0.9
	Bonneville T100	04→	DPR8EA-9	4929			DPR8EIX-9	2202	0.9
	Scrambler	05→	DPR8EA-9	4929			DPR8EIX-9	2202	0.9
	Speedmaster	05→	DPR8EA-9	4929			DPR8EIX-9	2202	0.9
	Thrupton 900	03→	DPR8EA-9	4929			DPR8EIX-9	2202	0.9
	Thrupton SE	10→	DPR8EA-9	4929			DPR8EIX-9	2202	0.9
885	Adventurer	96→01	DPR8EA-9	4929			DPR8EIX-9	2202	0.9
	Daytona, Daytona Super III	91→96	DPR8EA-9	4929			DPR8EIX-9	2202	0.9
	Legend TT	98→01	DPR8EA-9	4929			DPR8EIX-9	2202	0.9
	Speed Triple	94→96	DPR8EA-9	4929			DPR8EIX-9	2202	0.9
	Sprint	91→96	DPR8EA-9	4929			DPR8EIX-9	2202	0.9
	T509 Speed Triple	96→10/98	DPR8EA-9	4929			DPR8EIX-9	2202	0.9
	T709 Tiger	98→	DPR8EA-9	4929			DPR8EIX-9	2202	0.9
	Thunderbird	95→04	DPR8EA-9	4929			DPR8EIX-9	2202	0.9
	Thunderbird Sport	98→04	DPR8EA-9	4929			DPR8EIX-9	2202	0.9
	Tiger	91→98	DPR8EA-9	4929			DPR8EIX-9	2202	0.9
	Trident	91→98	DPR8EA-9	4929			DPR8EIX-9	2202	0.9
	Trophy	91→01	DPR8EA-9	4929			DPR8EIX-9	2202	0.9
955	Daytona 955i (Ø12mm Plug)	98→01	DPR8EA-9	4929			DPR8EIX-9	2202	0.9
	Daytona 955i (Ø10mm Plug)	01→06	CR9EK	4548			CR9EIX	3521	0.7
	Speed Triple (Ø12mm Plug)	10/98→01	DPR8EA-9	4929			DPR8EIX-9	2202	0.9
	Speed Triple (Ø10mm Plug)	01→04	CR9EK	4548			CR9EIX	3521	0.7
	Sprint RS (Ø12mm Plug)	99→00	DPR8EA-9	4929			DPR8EIX-9	2202	0.9
	Sprint RS (Ø10mm Plug)	01→05	CR9EK	4548			CR9EIX	3521	0.7



CC	MODEL	DATE	STANDARD COPPER CORE	STOCK NUMBER	PLATINUM OR GOLD PALLADIUM	STOCK NUMBER	IRIDIUM	STOCK NUMBER	GAP MM
TRIUMPH 1991-ON (CONTINUED)									
955	Sprint ST (Ø12mm Plug)	98→00	DPR8EA-9	4929			DPR8EIX-9	2202	0.9
	Sprint ST (Ø10mm Plug)	01→	CR9EK	4548			CR9EIX	3521	0.7
	T595 Daytona	97→98	DPR8EA-9	4929			DPR8EIX-9	2202	0.9
	Tiger EFI	00→07	DPR8EA-9	4929			DPR8EIX-9	2202	0.9
1000	Daytona	91→93	DPR8EA-9	4929			DPR8EIX-9	2202	0.9
1050	Speed Triple	05→	CR8EK	3478			CR8EIX	4218	0.7
	Sprint GT	10→	CR8EK	3478			CR8EIX	4218	0.7
	Sprint ST (Incl. ABS)	04→	CR8EK	3478			CR8EIX	4218	0.7
	Tiger (Incl. ABS)	06→	CR8EK	3478			CR8EIX	4218	0.7
	Tiger Sport	13→	CR8EK	3478			CR8EIX	4218	0.7
1180	Daytona 1200	91→00	DPR8EA-9	4929			DPR8EIX-9	2202	0.9
	Trophy 1200	91→03	DPR8EA-9	4929			DPR8EIX-9	2202	0.9
1215	Tiger Explorer	12→	CR8EK	3478			CR8EIX	4218	0.7
	Trophy (Incl. SE)	11/12→	CR8EK	3478			CR8EIX	4218	0.7
1600	Thunderbird (Twin Spark)	09→	DPR6EA-9	5531					0.9
1700	Thunderbird Storm (Twin Spark)	11→	DPR6EA-9	5531					0.9
2300	Rocket III (Twin Spark)	04→	DPR7EA-9	5129			DPR7EIX-9	7803	0.9
	Rocket III Classic (Twin Spark)	06→	DPR7EA-9	5129			DPR7EIX-9	7803	0.9
	Rocket III Touring (Twin Spark)	07→	DPR7EA-9	5129			DPR7EIX-9	7803	0.9

URALMOTO									
650	Cobra, Red Star, Voyage	→00	BP7HS	5111			BPR7HIX	5944	0.8
750	Classic, Wolf	00→07	BP6HS	4511			BPR6HIX	4085	0.6

VERTEMATI									
500	S501		CR9EK	4548			CR9EIX	3521	0.7
	SR501		CR9EK	4548			CR9EIX	3521	0.7
570	S570	03→	CR9EK	4548			CR9EIX	3521	0.7

VESPA (SEE PIAGGIO)

VICTORY (POLARIS)									
1507	V92C and all 92 cu.inch models	99→01	DCPR6E	3481					1.0
	V92C and all 92 cu.inch models	02→04	CPR6EB-9	5958					0.8
1634	Hammer, Kingpin, Touring Cruiser	05→08	CPR6EB-9	5958					0.9
	Hammer 8-Ball, Kingpin 8-Ball, Vegas, Vegas 8-Ball, Vegas Jackpot	05→	CPR6EB-9	5958					0.9
1731	Arlen Ness Vision, Cory Ness Jackpot	10→	DCPR6E	3481					0.8
	Broadwalk	13→	DCPR6E	3481					0.8
	Cross Country, Cross Country Tour, Cross Roads, Jackpot, Vision 8-Ball	10→	DCPR6E	3481					0.8
	Hammer/S, Vegas Jackpot, Vision Street/Tour	08→	DCPR6E	3481					0.8

VIXEN (SEE BASHAN)

VOR									
400	EN, MX, SM	00→	CR8EK	3478			CR8EIX	4218	0.7
503	EN, MX, SM	99→	CR8EK	3478			CR8EIX	4218	0.7
530	530 (2002)	02→	CR8EK	3478			CR8EIX	4218	0.7

WHITE KNUCKLE (SEE WK)

WK									
50	GP50 (Air Cooled)	10→	BPR7HS	6422			BPR7HIX	5944	0.6

2 Wheel



CC	MODEL	DATE	STANDARD COPPER CORE	STOCK NUMBER	PLATINUM OR GOLD PALLADIUM	STOCK NUMBER	IRIDIUM	STOCK NUMBER	GAP MM
WUYANG									
50	WY50QT Scooter	06→	C7HSA	4629			CR7HIX	7544	0.6
125	WY125-12	06→	DPR8EA-9	4929			DPR8EIX-9	2202	0.9
	WY125-16C	06→	DPR8EA-9	4929			DPR8EIX-9	2202	0.9
	WY125-24B Cub	06→	C7HSA	4629			CR7HIX	7544	0.6

XISPA									
125	X125R	07→08	BP5ES	6511			BPR5EIX	6597	0.6
250	X250R	07→08	BP5ES	6511			BPR5EIX	6597	0.6
273	X280R	07→08	BP5ES	6511			BPR5EIX	6597	0.6

YAMAHA									
50	CA50 (Salient)	84→87	BP6HS	4511			BPR6HIX	4085	0.6
	CG50E Jog	88→92	BPR7HS	6422			BPR7HIX	5944	0.6
	CS50 Jog R (Air Cooled)	02→07	BR8HS	4322			BR8HIX	7001	0.6
	CS50 Jog-RR (Liquid Cooled 2-Stroke)	03→07	BR8HS	4322			BR8HIX	7001	0.7
	CS50Z Jog RR	07→	BR8HS	4322			BR8HIX	7001	0.7
	CW50 RSP (Spy)	96→	BR8HS	4322			BR8HIX	7001	0.6
	CW50/BW50 NG Bi-Wizz, Booster, Rocket	90→95	BPR7HS	6422			BPR7HIX	5944	0.6
	CW50/BW50 NG Bi-Wizz, Booster, Rocket	96→	BR8HS	4322			BR8HIX	7001	0.6
	CW50T/BW	90→95	BPR7HS	6422			BPR7HIX	5944	0.6
	CW50T/BW	96→	BR8HS	4322			BR8HIX	7001	0.6
	CY50 Jog-in	90→98	BPR7HS	6422			BPR7HIX	5944	0.5
	DT50	2004	BR7HS	4122			BR7HIX	7067	0.6
	DT50M/MX	86→95	BR7HS	4122			BR7HIX	7067	0.6
	DT50R		BR9ES	5722			BR9EIX	3981	0.7
	DT50SM	2004	BR9ES	5722			BR9EIX	3981	0.7
	EW 50 Slider / Stunt	00→02	BR9HS	4522			BR9HIX	5687	0.6
	FS1	87→91	BR7HS	4122			BR7HIX	7067	0.6
	FS1E		B7HS	5110			BR7HIX	7067	0.6
	LC50 Bop 2		BP4HS	3611					0.7
	MA50 M	86→93	BP4HS	3611					0.7
	MS50	85→87	BPR6HS	7022			BPR6HIX	4085	0.6
	PW50 H/J/K/L		BP4HS	3611					0.6
	PW50S		BPR4HS	7823					0.6
	QT50	86→93	BP4HS	3611					0.7
	RD50M/MX	86→89	B7HS	5110			BR7HIX	7067	0.6
	SA50 Pasola	82→86	BP4HS	3611					0.7
	T50	86→89	CR6HS	7023			CR6HIX	7274	0.6
	TT-R50E	06→	CR7HSA	4549			CR7HIX	7544	0.6
	TY50M		B7HS	5110			BR7HIX	7067	0.6
	TZR50 X-Power	03→04	BR9ES	5722			BR9EIX	3981	0.7
	U50/AD/C/E		B7HS	5110			BR7HIX	7067	0.6
	V50	83→86	BR6ES	4922					0.6
	V50FM		B7HS	5110			BR7HIX	7067	0.6
V50MA		B6HS	4510			BR6HIX	3419	0.6	
XF50 Giggle	07→	CR7E	4578			CR7EIX	7385	0.8	
YH50 WHY	99→03	BR8HS	4322			BR8HIX	7001	0.6	
YN50 Neo's, Ovetto	98→08	BR7HS	4122			BR7HIX	7067	0.6	
YN50 Neo's 4s	09→	CR7E	4578			CR7EIX	7385	0.8	
YQ50 Aerox, Nitro	98→07	BR8HS	4322			BR8HIX	7001	0.6	
YQ50 Aerox R	04→	BR8HS	4322			BR8HIX	7001	0.6	
YZ50H		B9ES	2611	B9EVX	7254	BR9EIX	3981	0.6	
ZE50 (Zest)	93→96	BR7HS	4122			BR7HIX	7067	0.6	
70	V70		B7HS	5110			BR7HIX	7067	0.6
80	CV80	82→86	BPR6HS	7022			BPR6HIX	4085	0.6
	DT80MX	82→85	B8HS	5510	B8HVX	2634	BR8HIX	7001	0.6
	DT80MXS	86→87	BP8HS	2630			BPR8HIX	6742	0.6
	LB2-80 Chappy	81→85	B6HS	4510			BR6HIX	3419	0.6
	PW80K		BP6HS	4511			BPR6HIX	4085	0.6
	PW80S		BPR6HS	7022			BPR6HIX	4085	0.6
	RD80LC11A	82→84	B8ES	2411			BR8EIX	5044	0.6



CC	MODEL	DATE	STANDARD COPPER CORE	STOCK NUMBER	PLATINUM OR GOLD PALLADIUM	STOCK NUMBER	IRIDIUM	STOCK NUMBER	GAP MM
YAMAHA (CONTINUED)									
80	T80 Townmate	83→97	CR7HS	7223			CR7HIX	7544	0.6
	TY80B		B6HS	4510			BR6HIX	3419	0.6
	V80	79→87	BPR6HS	7022			BPR6HIX	4085	0.6
	YZ80 (1/2", 12.7mm Thread Reach)		B7HS	5110			BR7HIX	7067	0.5
	YZ80 (3/4", 19mm Thread Reach)	79→	BR9EG	3230			BR9EIX	3981	0.5
	YZ80 B		B8HS	5510	B8HVX	2634	BR8HIX	7001	0.6
	YZ80 C/D		B8ES	2411			BR8EIX	5044	0.6
	YZ80 E/F		B10EG	3630	B10EGV	5927	BR10EIX	6801	0.5
85	YZ85	03→	BR10EG	3830			BR10EIX	6801	0.6
90	TT90-R	03→	CR6HSA	2983			CR6HIX	7274	0.7
	V90		B7HS	5110			BR7HIX	7067	0.5
100	DT100 (C/X)		B7ES	1111			BR7EIX	6664	0.5
	DT100 (D/SD/E)		B8ES	2411			BR8EIX	5044	0.5
	DT100B		B8HS	5510	B8HVX	2634	BR8HIX	7001	0.5
	RS100 (B/X/DX/S)		B8HS	5510	B8HVX	2634	BR8HIX	7001	0.5
	RS100P		BP6HS	4511			BPR6HIX	4085	0.5
	RT100		B7ES	1111			BR7EIX	6664	0.6
	RXS100	83→97	BR8HS	4322			BR8HIX	7001	0.6
	YB100	87→92	B7HS	5110			BR7HIX	7067	0.5
	YN100 Neos, Ovetto	11/99→03	BR8HS	4322			BR8HIX	7001	0.5
	YQ100 Aerox, Nitro	00→04	BR8HS	4322			BR8HIX	7001	0.5
	YZ100H		B8EG	3430	B8EGV	5627	BR8EIX	5044	0.5
	YZ100K		B9EG	3530	B9EGV	5827	BR9EIX	3981	0.5
	YZ100L		BR9EG	3230			BR9EIX	3981	0.6
125	AS3		B8HS	5510	B8HVX	2634	BR8HIX	7001	0.6
	BL125 Beluga	85→87	BPR8HS	3725			BPR8HIX	6742	0.6
	Black X-max 125	09→	CPR9EA-9	2308					0.9
	BW's 125	10→	CR7E	4578			CR7EIX	7385	0.8
	DT125 (E/ED/MX)		B8ES	2411			BR8EIX	5044	0.5
	DT125LC	84→87	BR8ES	5422			BR8EIX	5044	0.6
	DT125R	88→04	BR9ES	5722			BR9EIX	3981	0.6
	DT125RE	04→07	BR8ES	5422			BR8EIX	5044	0.7
	DT125X	04→07	BR8ES	5422			BR8EIX	5044	0.6
	HW125 Xenter	12→	CPR9EA-9	2308					0.9
	NXC125 Cygnus X	04→	CR7E	4578			CR7EIX	7385	0.8
	RD125 (1/2", 12.7mm Thread Reach)		B8HS	5510	B8HVX	2634	BR8HIX	7001	0.6
	RD125 C-DX, DX, D-DX (3/4", 19mm Thread Reach)		B8ES	2411			BR8EIX	5044	0.6
	RD125LC	85→86	BR9ES	5722			BR9EIX	3981	0.7
	RDZ125	87→89	BR9ES	5722			BR9EIX	3981	0.7
	RS125 (Z/DX)	76→84	B8HS	5510	B8HVX	2634	BR8HIX	7001	0.5
	RS125E		B7HS	5110			BR7HIX	7067	0.6
	SR125	91→03	DR8EA	7162	DR8EVX	6354	DR8EIX	6681	0.6
	T125 (H/J)		B9EG	3530	B9EGV	5827	BR9EIX	3981	0.6
	TDR 125	93→97	BR9ES	5722			BR9EIX	3981	0.7
	TT-R125/LW		CR7HSA	4549			CR7HIX	7544	0.7
	TT-R125E	05→	CR7HSA	4549			CR7HIX	7544	0.7
	TW125	98→04	DR8EA	7162	DR8EVX	6354	DR8EIX	6681	0.6
	TY125		B7ES	1111			BR7EIX	6664	0.6
	TZR125	87→93	BR9ES	5722			BR9EIX	3981	0.7
	TZR125R	93→97	BR9ECM	3252	BR9ECMVX	2434			0.7
	VP125 X-City	07→	CPR9EA-9	2308					0.9
	WR125R	09→	CR8E	1275			CR8EIX	4218	0.7
	WR125X	09→	CR8E	1275			CR8EIX	4218	0.7
	XC125	92→96	CR6HSA	2983			CR6HIX	7274	0.6
	XC125 Cygnus	95→99	CR7E	4578			CR7EIX	7385	0.8
	XC125 Vity 125	08→	CR7E	4578			CR7EIX	7385	0.6
	XN125 Teos, Doodo	00→03	CR8E	1275			CR8EIX	4218	0.5
	XQ125 Maxster, Thunder	01→03	CR8E	1275			CR8EIX	4218	0.7
	XT125	82→85	D8EA	2120	DR8EVX	6354	DR8EIX	6681	0.7
	XT125R	05→	CR7HSA	4549			CR7HIX	7544	0.7
	XT125X	05→	CR7HSA	4549			CR7HIX	7544	0.7
	XV125 Virago	97→01	CR6HSA	2983			CR6HIX	7274	0.6
	XVS125 Drag Star	99→04	CR7HSA	4549			CR7HIX	7544	0.7
	Y125E/F		BR9EG	3230			BR9EIX	3981	0.5



CC	MODEL	DATE	STANDARD COPPER CORE	STOCK NUMBER	PLATINUM OR GOLD PALLADIUM	STOCK NUMBER	IRIDIUM	STOCK NUMBER	GAP MM	
YAMAHA (CONTINUED)										
125	YA6		B7HS	5110			BR7HIX	7067	0.6	
	YBR125	05→	CR6HSA	2983			CR6HIX	7274	0.6	
	YBR125 Custom	09→	CR6HSA	2983			CR6HIX	7274	0.6	
	YP125 Majesty, Skyliner	99→	CR8E	1275			CR8EIX	4218	0.7	
	YP125R X-Max 125	00→05	CR8E	1275			CR8EIX	4218	0.7	
	YP125R X-Max 125	06→	CPR9EA-9	2308					0.9	
	YZ125 (Air Cooled)	74→80	B9EG	3530	B9EGV	5827	BR9EIX	3981	0.5	
	YZ125 (Liquid Cooled)	81→91	B9EG	3530	B9EGV	5827	BR9EIX	3981	0.5	
	YZ125	91→96	BR9EG	3230			BR9EIX	3981	0.5	
	YZ125	96→98	B9EG	3530	B9EGV	5827	BR9EIX	3981	0.5	
	YZ125	98→05	BR9EG	3230			BR9EIX	3981	0.5	
	YZ125	05→					BR9EIX	3981	0.5	
	YZF-R125	08→	CR8E	1275			CR8EIX	4218	0.7	
	175	DT175 (E/MX)	78→85	B8ES	2411			BR8EIX	5044	0.5
IT175H			B9EG	3530	B9EGV	5827	BR9EIX	3981	0.5	
TY175 (E/JC)			B7ES	1111			BR7EIX	6664	0.5	
200	CS5E		B8HS	5510	B8HVX	2634	BR8HIX	7001	0.6	
	RD200 (All models except B)	76→83	B8ES	2411			BR8EIX	5044	0.6	
	RD200B (1/2", 12.7mm Thread Reach)		B8HS	5510	B8HVX	2634	BR8HIX	7001	0.6	
	RD200B (3/4", 19mm Thread Reach)		B8ES	2411			BR8EIX	5044	0.6	
	RS200		B8ES	2411			BR8EIX	5044	0.6	
	WR200E		BR9ES	5722			BR9EIX	3981	0.6	
250	Black X-max 250	09→	DR8EA	7162	DR8EVX	6354	DR8EIX	6681	0.7	
	DT250 (E/MX)		B8EG	3430	B8EGV	5627	BR8EIX	5044	0.6	
	IT250H		B9EG	3530	B9EGV	5827	BR9EIX	3981	0.6	
	MX250		B8EG	3430	B8EGV	5627	BR8EIX	5044	0.6	
	RD250 (D)	1977	B8ES	2411			BR8EIX	5044	0.6	
	RD250 (E/F)	78→79	B9ES	2611	B9EVX	7254	BR9EIX	3981	0.7	
	RD250 (LC)	80→85	BR8ES	5422			BR8EIX	5044	0.6	
	SR250	80→82	BP7ES	2412	BP7EVX	7270	BPR7EIX	4055	0.7	
	SR250S	93→95	BP7ES	2412	BP7EVX	7270	BPR7EIX	4055	0.7	
	TDR250	88→92	BR9ES	5722			BR9EIX	3981	0.7	
	TT250R	03→	CR9E	6263			CR9EIX	3521	0.8	
	TY250N		BR8ES	5422			BR8EIX	5044	0.6	
	TY250R		BR6ES	4922					0.6	
	TY250Z				BP6EVX	5832	BPR6EIX	6637	0.7	
	TZR250	87→91	BR9ES	5722			BR9EIX	3981	0.6	
	VP250 X-City	07→	DPR8EA-9	4929			DPR8EIX-9	2202	0.9	
	WR250F	01→	CR8E	1275			CR8EIX	4218	0.7	
	WR250F (S)	04→06	CR8E	1275			CR8EIX	4218	0.7	
	WR250F (S)	07→	CR9E	6263			CR9EIX	3521	0.8	
	WR250R	08→	CR9EK	4548			CR9EIX	3521	0.7	
	WR250X	08→	CR9EK	4548			CR9EIX	3521	0.7	
	WR250Z	93→	B8EG	3430	B8EGV	5627	BR8EIX	5044	0.5	
	XS250 (E/CW/SE/C)		BP7ES	2412	BP7EVX	7270	BPR7EIX	4055	0.7	
	XT250	80→83	BP7ES	2412	BP7EVX	7270	BPR7EIX	4055	0.7	
	XV250 Virago	95→00	CR6HS	7023			CR6HIX	7274	0.6	
	XVS250 Drag Star	01→	CR6HSA	2983			CR6HIX	7274	0.7	
	YBR250	09→	DR8EA	7162	DR8EVX	6354	DR8EIX	6681	0.7	
	YP250 Majesty	96→04	DR8EA	7162	DR8EVX	6354	DR8EIX	6681	0.8	
	YP250R X-Max	05→	DR8EA	7162	DR8EVX	6354	DR8EIX	6681	0.8	
	YZ250 (E-V)		B8EG	3430	B8EGV	5627	BR8EIX	5044	0.6	
	YZ250A		B8EG	3430	B8EGV	5627	BR8EIX	5044	0.6	
	YZ250E		B8EG	3430	B8EGV	5627	BR8EIX	5044	0.5	
	YZ250F (4-Stroke)	01→	CR8E	1275			CR8EIX	4218	0.7	
	YZ250F (S)	04→	CR8E	1275			CR8EIX	4218	0.7	
	YZ250G	1995	B8EG	3430	B8EGV	5627	BR8EIX	5044	0.5	
	YZ250H		B9EG	3530	B9EGV	5827	BR9EIX	3981	0.6	
	YZ250WR	→04	B8EG	3430	B8EGV	5627	BR8EIX	5044	0.6	
	YZ250WR	05→	BR8EG	3130			BR8EIX	5044	0.6	
	264	VP300 Versity	03→04	DR8EA	7162	DR8EVX	6354	DR8EIX	6681	0.7



CC	MODEL	DATE	STANDARD COPPER CORE	STOCK NUMBER	PLATINUM OR GOLD PALLADIUM	STOCK NUMBER	IRIDIUM	STOCK NUMBER	GAP MM
YAMAHA (CONTINUED)									
350	RD350 (Air Cooled) (1/2", 12.7mm Thread Reach)	73→74	B8HS	5510	B8HVX	2634	BR8HIX	7001	0.6
	RD350 (Air Cooled) (3/4", 19mm Thread Reach)	75→	B8ES	2411			BR8EIX	5044	0.6
	RD350LC-YPVS (Liquid Cooled)	83→85	BR8ES	5422			BR8EIX	5044	0.6
	RD350 (Liquid Cooled)	86→95	BR9ES	5722			BR9EIX	3981	0.6
	XT350	85→92	DR8ES-L	2923	DR8EVX	6354	DR8EIX	6681	0.6
400	DT400 (E/MX)		B9ES	2611	B9EVX	7254	BR9EIX	3981	0.6
	FZR400 RR/SP	91→95	CR8E	1275			CR8EIX	4218	0.7
	IT400		B8EG	3430	B8EGV	5627	BR8EIX	5044	0.6
	MX400		B8EG	3430	B8EGV	5627	BR8EIX	5044	0.6
	RD400 (C/D)		B8ES	2411			BR8EIX	5044	0.6
	RD400 (E/F)		B9ES	2611	B9EVX	7254	BR9EIX	3981	0.6
	WR400		CR8E	1275			CR8EIX	4218	0.7
	XS400 (E/2-E/F)		BP7ES	2412	BP7EVX	7270	BPR7EIX	4055	0.6
	YP400 Majesty	04→	CR7E	4578			CR7EIX	7385	0.8
	YZ400 (C/E)		B8EG	3430	B8EGV	5627	BR8EIX	5044	0.6
	YZ400F	98→	CR8E	1275			CR8EIX	4218	0.7
	426	WR426F Enduro		CR8E	1275			CR8EIX	4218
YZ426F Motocross			CR8E	1275			CR8EIX	4218	0.7
450	WR450F (S)	04→11	CR8E	1275			CR8EIX	4218	0.7
	WR450F Injection	12→	CR8E	1275			CR8EIX	4218	0.8
	YZ450F	03→	CR8E	1275			CR8EIX	4218	0.7
465	IT465H		B8EG	3430	B8EGV	5627	BR8EIX	5044	0.6
	YZ465H		B8EG	3430	B8EGV	5627	BR8EIX	5044	0.6
490	YZ490 (J/K/L/N/S/T/U)		B8EG	3430	B8EGV	5627	BR8EIX	5044	0.6
500	HL500		BP7ES	2412	BP7EVX	7270	BPR7EIX	4055	0.6
	RD500LC	84→87	BR9HS	4522			BR9HIX	5687	0.6
	SR500/E	78→83	BP7ES	2412	BP7EVX	7270	BPR7EIX	4055	0.6
	XP500 TMAX	01→11	CR7E	4578			CR7EIX	7385	0.7
	XS500/E		D9EA	2420	DR9EVX	6361	DR9EIX	4772	0.6
530	XP500 TMAX	12→	CR7E	4578			CR7EIX	7385	0.7
535	XV535/S/DX (Virago)	88→04	BPR7ES	2023			BPR7EIX	4055	0.7
550	XJ550	81→85	D8EA	2120	DR8EVX	6354	DR8EIX	6681	0.6
	XT550	82→84	DR7ES	3123					0.7
	XZ550	82→85	DR8ES	5423	DR9EVX	6361	DR9EIX	4772	0.7
600	FZ600 (Air Cooled)	86→88	DR8ES-L	2923	DR8EVX	6354	DR8EIX	6681	0.7
	FZ6-S / Fazer	04→06	CR9EK	4548			CR9EIX	3521	0.7
	FZ6-S S2 / Fazer S2	07→	CR9EK	4548			CR9EIX	3521	0.7
	FZR600 (Liquid Cooled)	89→94	CR9E	6263			CR9EIX	3521	0.8
	FZR600R	94→96	CR9E	6263			CR9EIX	3521	0.8
	FZS600 Fazer	98→04	CR8E	1275			CR8EIX	4218	0.6
	SRX600	86→89	DPR7EA-9	5129			DPR7EIX-9	7803	0.9
	TT600	86→03	DPR8EA-9	4929			DPR8EIX-9	2202	0.9
	TT600RE	04→	DPR8EA-9	4929			DPR8EIX-9	2202	0.9
	XJ6 (Incl. ABS)	08→	CR9E	6263			CR9EIX	3521	0.8
	XJ6 Diversion (Incl. ABS)	08→	CR9E	6263			CR9EIX	3521	0.8
	XJ6 Diversion F ABS	10→	CR9E	6263			CR9EIX	3521	0.8
	XJ600	84→91	DR8ES-L	2923	DR8EVX	6354	DR8EIX	6681	0.7
	XJ600S/N (Diversion)	92→02	CR8E	1275			CR8EIX	4218	0.6
	XT600	84→88	DPR7EA-9	5129			DPR7EIX-9	7803	0.9
	XT600E	90→	DPR8EA-9	4929			DPR8EIX-9	2202	0.9
	XT600Z Tenere	84→90	DPR7EA-9	5129			DPR7EIX-9	7803	0.9
	XT600ZE	86→91	DPR7EA-9	5129			DPR7EIX-9	7803	0.9
	YZF600R Thunder Cat	96→03	CR9E	6263			CR9EIX	3521	0.8
	YZF-R6	99→05	CR10EK	2360			CR10EIX	6482	0.7
YZF-R6	06→	CR10EK	2360			CR10EIX	6482	0.7	
650	XJ650	80→84	BP7ES	2412	BP7EVX	7270	BPR7EIX	4055	0.7
	XJ650T	82→85	BPR8ES	3923			BPR8EIX	6684	0.7
	XS2	72→73	B8ES	2411			BR8EIX	5044	0.6
	XS650 (E, SE, Special)	79→82	BP7ES	2412	BP7EVX	7270	BPR7EIX	4055	0.7
	XVS650 Drag Star	97→	DPR7EA-9	5129			DPR7EIX-9	7803	0.9
XVS650A Drag Star	98→	DPR7EA-9	5129			DPR7EIX-9	7803	0.9	



CC	MODEL	DATE	STANDARD COPPER CORE	STOCK NUMBER	PLATINUM OR GOLD PALLADIUM	STOCK NUMBER	IRIDIUM	STOCK NUMBER	GAP MM
YAMAHA (CONTINUED)									
660	MT-03	05→	CR7E	4578			CR7EIX	7385	0.8
	SZR660	95→97	DPR9EA-9	5329			DPR9EIX-9	5545	0.9
	XT660 R/X	04→	CR7E	4578			CR7EIX	7385	0.8
	XT660Z Tenere	08→	CR7E	4578			CR7EIX	7385	0.8
	XTZ660 Tenere	91→99	DPR8EA-9	4929			DPR8EIX-9	2202	0.9
750	FZ750	85→91	DR8ES-L	2923	DR8EVX	6354	DR8EIX	6681	0.6
	FZR750R	87→89	DR8ES-L	2923	DR8EVX	6354	DR8EIX	6681	0.6
	FZR750R OW01	89→91	DR9EA	3437	DR9EVX	6361	DR9EIX	4772	0.6
	FZX750	87→89	DR8ES-L	2923	DR8EVX	6354	DR8EIX	6681	0.6
	XJ750 (SECA)	82→84	BPR7ES	2023			BPR7EIX	4055	0.7
	XS750 (C, D, E, SE)	80→82	BPR7ES	2023			BPR7EIX	4055	0.7
	XTZ750 Super Tenere	89→95	DPR8EA-9	4929			DPR8EIX-9	2202	0.9
	XV750 Virago	92→96	BPR7ES	2023			BPR7EIX	4055	0.7
	YZF750R	93→96	CR9E	6263			CR9EIX	3521	0.7
	YZF750-R7 OW02	99→			R0256R-10	7641			0.8
	YZF750SP	93→96	CR9E	6263			CR9EIX	3521	0.7
779	FZ8, Fazer8	10→	CR9E	6263			CR9EIX	3521	0.7
850	TDM850	91→95	DPR9EA-9	5329			DPR9EIX-9	5545	0.9
	TDM850	96→01	DPR8EA-9	4929			DPR8EIX-9	2202	0.9
	TRX850	96→99	DPR8EA-9	4929			DPR8EIX-9	2202	0.9
	XS850	80→85	BP7ES	2412	BP7EVX	7270	BPR7EIX	4055	0.7
900	TDM 900	02→	DPR8EA-9	4929			DPR8EIX-9	2202	0.9
	XJ900F/S	83→94	BPR8ES	3923			BPR8EIX	6684	0.7
	XJ900S Diversion	95→04	DPR8EA-9	4929			DPR8EIX-9	2202	0.8
950	XVS950A Midnight Star	09→	CPRT7EA-9	3901				0.9	
1000	FZR1000	87→88	DR8ES-L	2923	DR8EVX	6354	DR8EIX	6681	0.7
	FZR1000 EXUP	89→93	DR8ES-L	2923	DR8EVX	6354	DR8EIX	6681	0.7
	FZR1000 EXUP	93→95	DR8EA	7162	DR8EVX	6354	DR8EIX	6681	0.8
	FZS1000 Fazer	01→05	CR9E	6263			CR9EIX	3521	0.7
	FZ-1 / Fazer	06→	CR9EK	4548			CR9EIX	3521	0.7
	GTS1000A	93→96	DPR8EA-9	4929			DPR8EIX-9	2202	0.9
	TR1	81→85	BP7ES	2412	BP7EVX	7270	BPR7EIX	4055	0.7
	XV1000SE	86→88	BPR7ES	2023			BPR7EIX	4055	0.7
	YZF1000R Thunderace	96→02	DR8EA	7162	DR8EVX	6354	DR8EIX	6681	0.8
	YZF-R1	98→01	CR9E	6263			CR9EIX	3521	0.7
	YZF-R1	02→03					CR9EIA-9	6289	0.9
	YZF-R1 (19mm Thread Reach)	04→08	CR9EK	4548			CR9EIX	3521	0.7
	YZF-R1SP (19mm Thread Reach)	2006	CR9EK	4548			CR9EIX	3521	0.7
	YZF-R1 (Incl. Anniversary) (26.5mm Thread Reach)	09→	LMAR9E-J	6884					0.7
1100	BT1100 Bulldog	02→06	BPR7ES	2023			BPR7EIX	4055	0.7
	FJ1100	84→85	DPR8EA-9	4929			DPR8EIX-9	2202	0.9
	XS1100 (E/S)	81→84	BP6ES	7811	BP6EVX	5832	BPR6EIX	6637	0.7
	XV1100 Virago	89→98	BPR7ES	2023			BPR7EIX	4055	0.7
	XVS1100/A Drag Star / Classic	99→	BPR7ES	2023			BPR7EIX	4055	0.7
1200	FJ1200/A, XVZ12TD	86→96	DPR8EA-9	4929			DPR8EIX-9	2202	0.9
	V-Max 1200	91→02	DPR8EA-9	4929			DPR8EIX-9	2202	0.9
	XJR1200	95→98	DPR8EA-9	4929			DPR8EIX-9	2202	0.8
	XT1200Z Super Tenere (Twin Spark)	10→	CPR8EB-9	6607					0.9
	XT1200Z World Crosser (Twin Spark)	12→	CPR8EB-9	6607					0.9
	XVZ12TD Venture	85→86	DPR8EA-9	4929			DPR8EIX-9	2202	0.8
1300	FJR1300/A	01→	CR8E	1275			CR8EIX	4218	0.7
	FJR1300A/AS	06→12	CR8E	1275			CR8EIX	4218	0.7
	FJR1300A/AS	13→	CPR8EA-9	2306			CR8EIX	4218	0.9
	XJR1300/SP	99→	DPR8EA-9	4929			DPR8EIX-9	2202	0.9
	XVS1300A Midnight Star	07→	LMAR7A-9	4908					0.9
	XVZ1300 TF Venture Star	99→01	DPR8EA-9	4929			DPR8EIX-9	2202	0.8
	XVZ13A Royal Star	96→98	DPR7EA-9	5129			DPR7EIX-9	7803	0.9
1600	XV1600/A Wild Star	99→02	DPR7EA-9	5129			DPR7EIX-9	7803	0.9
1670	MT-01 1600 (Twin Spark)	05→	DPR7EA-9	5129			DPR7EIX-9	7803	0.9
1679	VMAX 1700	08→					CR9EIA-9	6289	0.9
1700	XV1700 Road Star	03→	DPR7EA-9	5129			DPR7EIX-9	7803	0.9
1900	XV1900 Midnight Star	06→	DPR8EA-9	4929			DPR8EIX-9	2202	0.8



2 Wheel

CC	MODEL	DATE	STANDARD COPPER CORE	STOCK NUMBER	PLATINUM OR GOLD PALLADIUM	STOCK NUMBER	IRIDIUM	STOCK NUMBER	GAP MM
YAMASAKI									
125	YM125-3	11→	D8EA	2120	DR8EVX	6354	DR8EIX	6681	0.6

YIYING (SEE BENZHOU)

ZING (SEE LIFAN)

ZNEN									
125	ZN125F Firenze 125		C7HSA	4629			CR7HIX	7544	0.6

ZONGSHEN									
125	Arktix, Predator ZS125-GY10		DR8EA	7162	DR8EVX	6354	DR8EIX	6681	0.7
250	Storm ZS250GS		D8EA	2120	DR8EVX	6354	DR8EIX	6681	0.6

ATV Quad



CC	MODEL	DATE	STANDARD COPPER CORE	STOCK NUMBER	PLATINUM OR GOLD PALLADIUM	STOCK NUMBER	IRIDIUM	STOCK NUMBER	GAP MM
ADLY									
103	ATV-110 Fun bike	10→	BP7HS	5111			BPR7HIX	5944	0.7
300	ATV-300XS	10→	DR8EA	7162	DR8EVX	6354	DR8EIX	6681	0.7
320	ATV-320S, ATV-320U	12→	CR8E	1275			CR8EIX	4218	0.7

APACHE									
50	RLX 50		BR8HSA	5539			BPR8HIX	6742	0.7
	Tomahawk Mini 50 (4-Stroke)	→07	CR7HSA	4549			CR7HIX	7544	0.6
	Tomahawk Mini 50 (2-Stroke)	08→	BR8HSA	5539			BPR8HIX	6742	0.7
100	Army 100		BR8HSA	5539			BPR8HIX	6742	0.6
	RLX 100		BR8HSA	5539			BPR8HIX	6742	0.6
	SX 100		BR8HSA	5539			BPR8HIX	6742	0.6
	ZX100		BR8HSA	5539			BPR8HIX	6742	0.7
150	RLX 150 H		CR7HSA	4549			CR7HIX	7544	0.6
	RLX 150		CR7HSA	4549			CR7HIX	7544	0.6
	Superbug 150		CR7HSA	4549			CR7HIX	7544	0.6
170	RLX 170 S		DR8EA	7162	DR8EVX	6354	DR8EIX	6681	0.6
250	RLX 250 AX		DR8EA	7162	DR8EVX	6354	DR8EIX	6681	0.6
	RLX 250 S		CR8HS	7423	CR8HVX	7236	CR8HIX	7669	0.7
	RLX 250 SX		CR8HS	7423	CR8HVX	7236	CR8HIX	7669	0.7
280	RLX 320		DPR7EA-9	5129			DPR7EIX-9	7803	0.9
360	RLX 400	10→	CR8E	1275			CR8EIX	4218	0.7
450	RLX 450		CR8E	1275			CR8EIX	4218	0.7
500	RLX F500	10→	DPR7EA-9	5129			DPR7EIX-9	7803	0.9

ARCTIC CAT									
50	50	06→	CR7HSA	4549			CR7HIX	7544	0.6
90	90	06→	CR7HSA	4549			CR7HIX	7544	0.6
150	150	09→	DR8EA	7162	DR8EVX	6354	DR8EIX	6681	0.7
250	250	01→	DR7EA	7839					0.6
300	300	05→	DR7EA	7839					0.6
	DVX 300	08→	DPR7EA-9	5129			DPR7EIX-9	7803	0.9
366	400 H1	08→	CR7E	4578			CR7EIX	7385	0.7
400	400		CR7E	4578			CR7EIX	7385	0.7
	DVX 400	04→08	CR7E	4578			CR7EIX	7385	0.7
500	500		CR6E	6965					0.8
550	550		CPR8E	7411			CR8EIX	4218	0.8
650	650	04→05	CR7E	4578			CR7EIX	7385	0.7
	650 H1	05→	CPR8E	7411			CR8EIX	4218	0.8
700	700 H1	09→	CPR8E	7411			CR8EIX	4218	0.8
950	1000 Thundercat H2	09→	CPR8E	7411			CR8EIX	4218	0.8

BLAST (LEM)									
50	50		B7HS	5110			BR7HIX	7067	0.6
100	100		B7HS	5110			BR7HIX	7067	0.6

BOMBARDIER (→05)									
50	DS 50 (Rotax)	02→03	BPR7HS	6422			BPR7HIX	5944	0.6
	DS 50	04→05	BR9ECS	3570					0.7
90	DS 90 (Rotax 2-Stroke)	02→03	BPR7HS	6422			BPR7HIX	5944	0.6
	DS 90 (Rotax 2-Stroke)	04→05	BR9ECS	3570					0.7
	DS 90 (Rotax 4-Stroke)	02→	CR7HSA	4549			CR7HIX	7544	0.6
200	Rally (Rotax)	03→05	CR8E	1275			CR8EIX	4218	0.7
330	Outlander 330 HO (Rotax 4-TEC)	04→05	BR9ECS	3570					0.7
400	Outlander 400 HO (Rotax 4-TEC) Ø12mm Plug	03→	DCPR8E*	4179			DCR8EIX	3606	0.6
	Outlander 400 Ø14mm Plug	04→	BR9ECS	3570					0.7



* Please note DCPR8E 4339 has a removable terminal nut, whereas DCPR8E 4179 has a fixed terminal nut





CC	MODEL	DATE	STANDARD COPPER CORE	STOCK NUMBER	PLATINUM OR GOLD PALLADIUM	STOCK NUMBER	IRIDIUM	STOCK NUMBER	GAP MM
BOMBARDIER (→05) (CONTINUED)									
500	Traxter (Rotax) Ø12mm Plug	98→02	DR8EA	7162	DR8EVX	6354	DR8EIX	6681	0.7
	Traxter (Rotax) Ø14mm Plug	03→	BR9ECS	3570					0.7
	Traxter CVT	2005	DCPR8E*	4179			DCR8EIX	3606	0.7
650	DS 650 (Rotax) Ø12mm Plug	00→05	DR8EA	7162	DR8EVX	6354	DR8EIX	6681	0.7
	Quest 650 (Rotax 4-TEC) Ø12mm Plug	02→03	DR8EA	7162	DR8EVX	6354	DR8EIX	6681	0.7
	Quest 650 Ø14mm Plug	03→	BR9ECS	3570					0.7
	Traxter CVT	2005	DCPR8E*	4179			DCR8EIX	3606	0.7

CAN-AM (BRP)									
50	DS 50	06	BR9ECS	3570					0.7
70	DS 7	08→	CR7HSA	4549			CR7HIX	7544	0.7
90	DS 90 (Rotax 2-Stroke)	2006	BR9ECS	3570					0.7
	DS 90 (Rotax 4-Stroke)	06→	CR7HSA	4549			CR7HIX	7544	0.6
200	Rally (Rotax)	06→07	CR8E	1275			CR8EIX	4218	0.7
250	DS 250	06→	CR8E	1275			CR8EIX	4218	0.7
400	Outlander 400 HO (Rotax 4-TEC) Ø12mm Plug	06→	DCPR8E*	4179			DCR8EIX	3606	0.6
	Outlander 400 Ø14mm Plug	06→	BR9ECS	3570					0.7
	Outlander MAX	13→	DCPR8E*	4179			DCR8EIX	3606	0.7
450	DS 450	08→	DCPR9E	2641			DCR9EIX	6650	0.7
500	Outlander 500	07→	DCPR8E*	4179			DCR8EIX	3606	0.7
	Renegade 500	08→	DCPR8E*	4179			DCR8EIX	3606	0.7
	Traxter (Rotax) Ø14mm Plug	06→	BR9ECS	3570					0.7
650	DS 650 (Rotax) Ø12mm Plug	06→07	DR8EA	7162	DR8EVX	6354	DR8EIX	6681	0.7
	Outlander 650	06→	DCPR8E*	4179			DCR8EIX	3606	0.7
	Quest 650 Ø14mm Plug	06→	BR9ECS	3570					0.7
800	Commander 800	11→	DCPR8E*	4179			DCR8EIX	3606	0.7
	Outlander 800 (Incl. R, X & XC models)	06→	DCPR8E*	4179			DCR8EIX	3606	0.7
	Renegade 800	07→	DCPR8E*	4179			DCR8EIX	3606	0.7
1000	Commander 1000	11→	DCPR8E*	4179			DCR8EIX	3606	0.7
	Maverick	13→	LMAR8C-9	93833					0.9

CECTEK									
497	Gladiator	09→	CR7E	4578			CR7EIX	7385	0.7
	Quadrift	09→	CR7E	4578			CR7EIX	7385	0.7

CLUBCAR									
719	Carryall 294, 295 (Kubota D722 engine)	04→	YE01	2649					-

CPI									
50	ATV 50		BPR7HS	6422			BPR7HIX	5944	0.7
	XT50R		BR7HS	4122			BR7HIX	7067	0.7
100	ATV 100		BPR7HS	6422			BPR7HIX	5944	0.7
200	ATV 200		BR7HS	4122			BR7HIX	7067	0.7

CUB CADET									
624	Volunteer 4x4 (Kohler CH640 engine)		BCPR5ES	6130			BCPR5EIX	5688	0.7
747	Volunteer 4x4 EFI (Kohler Aegis LH775 engine)		BPR5E	7075			BPR5EIX	6597	0.7

DINLI									
50	JP 50Z		BPR7HS	6422			BPR7HIX	5944	0.7
150	Diablo 150	05→07	C7HSA	4629			CR7HIX	7544	0.7



* Please note DCPR8E 4339 has a removable terminal nut, whereas DCPR8E 4179 has a fixed terminal nut



ATV Quad



CC	MODEL	DATE	STANDARD COPPER CORE	STOCK NUMBER	PLATINUM OR GOLD PALLADIUM	STOCK NUMBER	IRIDIUM	STOCK NUMBER	GAP MM
E-TON									
40	JXL40 Viper	03→	BPM7A	7321					0.6
	RXL40E		BPM7A	7321					0.6
50	RXL50 Viper	02→	BPR7HS	6422			BPR7HIX	5944	0.7
70	RXL70		BPR7HS	6422			BPR7HIX	5944	0.7
90	DXL90 Sierra	03→	BPR7HS	6422			BPR7HIX	5944	0.7
	RXL90 R		BPR7HS	6422			BPR7HIX	5944	0.7
	RXL90 Viper	02→	BPR7HS	6422			BPR7HIX	5944	0.7
150	CXL150 Challenger	99→	C7HSA	4629			CR7HIX	7544	0.7
	RXL150 Viper	09→	C7HSA	4629			CR7HIX	7544	0.7
	YXL150 Yukon	99→	C7HSA	4629			CR7HIX	7544	0.7
250	VXL250 Vector	07→	CR8E	1275			CR8EIX	4218	0.6

GAS GAS									
50	Quad 50		B9ES	2611	B9EVX	7254	BR9EIX	3981	0.6
250	Quad 250	07→	DPR7EA-9	5129			DPR7EIX-9	7803	0.7
300	Wild HP	03→	BR8EG	3130			BR8EIX	5044	0.5
450	Wild HP	03→	CR8E	1275			CR8EIX	4218	0.7

HONDA									
70	ATC70, ATC70-D	78→85	CR7HS	7223			CR7HIX	7544	0.7
90	TRX90 Sportrax	94→	CR6HSA	2983			CR6HIX	7274	0.6
110	ATC110	79→85	DR8HS	5123					0.7
125	ATC125M	84→87	DR8ES-L	2923	DR8EVX	6354	DR8EIX	6681	0.7
	TRX125 All variants	85→88	DR8ES-L	2923	DR8EVX	6354	DR8EIX	6681	0.7
185	ATC185S-D	79→82	DR8ES-L	2923	DR8EVX	6354	DR8EIX	6681	0.7
200	ATC200 (EC/XD/ESE)	81→84	DR8ES-L	2923	DR8EVX	6354	DR8EIX	6681	0.7
	TRX200 All variants	84→97	DR8ES-L	2923	DR8EVX	6354	DR8EIX	6681	0.7
250	ATC250R-D	81→83	BR8ES	5422			BR8EIX	5044	0.7
	ATC250R-F/G	85→86	BR9ES	5722			BR9EIX	3981	0.7
	TRX250 RH, RJ, RK	86→89	BR9ES	5722			BR9EIX	3981	0.7
	TRX250 EX Sportrax	01→08	DPR8EA-9	4929			DPR8EIX-9	2202	0.9
	TRX250 TM/TE Fourtrax S/ES	02→	DPR8EA-9	4929			DPR8EIX-9	2202	0.9
300	TRX300FW-V	94→99	DPR8EA-9	4929			DPR8EIX-9	2202	0.9
	TRX300EX	00→01	DR8ES-L	2923	DR8EVX	6354	DR8EIX	6681	0.7
350	TRX350-H, J, K, L, M, N, P	86→93	DR8ES-L	2923	DR8EVX	6354	DR8EIX	6681	0.7
	TRX350 TM/TE Fourtrax S/ES	01→06	DPR7EA-9	5129			DPR7EIX-9	7803	0.9
400	TRX400AT Fourtrax	05→	DPR8EA-9	4929			DPR8EIX-9	2202	0.9
	TRX400EX Sportrax	05→	DPR8EA-9	4929			DPR8EIX-9	2202	0.9
420	TRX420 FE/FM/FPM/TE/TM Fourtrax ES	07→	BKR5E-11	6953			BKR5EIX-11	5464	1.1
450	TRX450 FE/FM ES/S	97→02	DPR7EA-9	5129			DPR7EIX-9	7803	0.9
	TRX450R Sportrax	06→					IFR8H11	5068	1.1
475	TRX500 ES/FM/FE Foreman Ø14mm Plug (Manual)	05→	BKR5E-11	6953			BKR5EIX-11	5464	1.1
500	TRX500 FA1, FA2, FA3 Foreman AT Ø12mm Plug (Auto)	01→					IJR7A9	7901	0.9
650	TRX650FA Rincon AT	04→					IFR5L11	6502	1.1
675	TRX680FA Rincon	05→					IFR5L11	6502	1.1

HYMOTO									
70	HQ70		C7HSA	4629			CR7HIX	7544	0.7
110	HQ110		C7HSA	4629			CR7HIX	7544	0.7
200	HQ200SRL		DR8EA	7162	DR8EVX	6354	DR8EIX	6681	0.7
300	HQ300 4x4 / SRL		DR8EA	7162	DR8EVX	6354	DR8EIX	6681	0.7

HYOSUNG									
50	TE50	07→	BPR6HS	7022			BPR6HIX	4085	0.7
90	TE90	07→	BPR7HS	6422			BPR7HIX	5944	0.7
100	TE100R	04→	BPR7HS	6422			BPR7HIX	5944	0.7
450	TE450 Rapier	07→	CR8E	1275			CR8EIX	4218	0.7



CC	MODEL	DATE	STANDARD COPPER CORE	STOCK NUMBER	PLATINUM OR GOLD PALLADIUM	STOCK NUMBER	IRIDIUM	STOCK NUMBER	GAP MM
KAWASAKI									
50	KFX50 A	03→	BPR4HS	7823					0.7
220	KLF220 A	88→02	DR8ES	5423	DR9EVX	6361	DR9EIX	4772	0.7
250	KLF250	03→	DR8ES	5423	DR9EVX	6361	DR9EIX	4772	0.6
300	KAF300 A-C (Mule 500/550)	91→04	BPR5ES	7422			BPR5EIX	6597	0.8
	KLF300 (Ø14mm Plug)	86→88	BR8ES	5422			BR8EIX	5044	0.6
	KLF300 (Ø12mm Plug)	89→	DR8EA	7162	DR8EVX	6354	DR8EIX	6681	0.7
	KVF300	99→04	DR8EA	7162	DR8EVX	6354	DR8EIX	6681	0.7
	KVF300	12→	DPR7EA-9	5129			DPR7EIX-9	7803	0.9
360	KVF360	02→	DPR8EA-9	4929			DPR8EIX-9	2202	0.9
400	KAF400 A, B (Mule 600/610)	05→	BPR6ES	7822			BPR6EIX	6637	0.6
	KFX400	03→	CR7E	4578			CR7EIX	7385	0.7
	KLF400 B	93→99	DPR8EA-9	4929			DPR8EIX-9	2202	0.9
	KVF400	99→	DPR8EA-9	4929			DPR8EIX-9	2202	0.9
450	KAF450 (Mule 1000)	88→	D6EA	7512					0.7
	KFX450R	08→	CPR8EB-9	6607			CR8EIX	4218	0.9
540	KAF540 C (Mule 2010)	02→05	BP5ES	6511			BPR5EIX	6597	0.5
620	KAF620 D (Mule 2500E)	1990	BMR4A	5728					0.7
	KAF620 A-D (Mule 2510/2500)	93→00	BMR2A	7677					0.7
	KAF620 E, G (Mule 3010/3000)	01→	BPR2ES	2264					0.7
650	KVF650	02→	CR7E	4578			CR7EIX	7385	0.7
700	KFX700 V Force	04→	CR7E	4578			CR7EIX	7385	0.7
	KVF700 A	04→	CR7E	4578			CR7EIX	7385	0.7
750	KVF750 A-D	05→	CR7E	4578			CR7EIX	7385	0.7
950	KAF950 A-D Diesel (Mule 2510, 3010)	98→08	Y-706R	3041					-

KAZUMA									
50	Meerkat		C7HSA	4629			CR7HIX	7544	0.6
90	Falcon		C7HSA	4629			CR7HIX	7544	0.6
110	Baby Falcon, Falcon, Panda Lacoste		C7HSA	4629			CR7HIX	7544	0.6
150	Dingo, Falcon		C7HSA	4629			CR7HIX	7544	0.6
500	Jaguar		BKR6E	6962			BKR6EIX	6418	0.7
800	Mammoth		BPR6ES	7822			BPR6EIX	6637	0.6

KTM									
450	450 SX (Ø10mm Plug)	09→	CR9EKB	2305			CR9EIX	3521	0.8
	450 XC (Ø12mm Plug)	08→	DCPR8E*	4179			DCR8EIX	3606	0.6
477	505 SX (Ø10mm Plug)	09→	CR9EKB	2305			CR9EIX	3521	0.8
510	525 XC (Ø12mm Plug)	08→	DCPR8E*	4179			DCR8EIX	3606	0.6

KUBOTA									
898	RTV900	04→	YE01	2649					-
1123	RTV1100	07→	YE01	2649					-

KYMCO									
50	KXR 50		BR8HSA	5539			BPR8HIX	6742	0.6
90	KXR 90		C7HSA	4629			CR7HIX	7544	0.7
150	MXer 150 /RL	01→	DR8EA	7162	DR8EVX	6354	DR8EIX	6681	0.7
	MXU 150 RL	05→	DR8EA	7162	DR8EVX	6354	DR8EIX	6681	0.7
250	KXR 250 /RL	01→	DPR7EA-9	5129			DPR7EIX-9	7803	0.9
	MXU 250 RL, Maxxer 250		DPR7EA-9	5129			DPR7EIX-9	7803	0.9
300	MXU 300 RL, Maxxer 300	05→	DPR7EA-9	5129			DPR7EIX-9	7803	0.9
400	MXU 400		CR8E	1275			CR8EIX	4218	0.7
443	MXU 450i	12→	CR7E	4578			CR7EIX	7385	0.6
500	MXU 500	→11	CR7E	4578			CR7EIX	7385	0.6
	MXU 500i IRS	12→	CR7E	4578			CR7EIX	7385	0.6
	UXV 500		CR7E	4578			CR7EIX	7385	0.9



* Please note DCPR8E 4339 has a removable terminal nut, whereas DCPR8E 4179 has a fixed terminal nut



ATV Quad



CC	MODEL	DATE	STANDARD COPPER CORE	STOCK NUMBER	PLATINUM OR GOLD PALLADIUM	STOCK NUMBER	IRIDIUM	STOCK NUMBER	GAP MM
LEM									
50	Beetlebug, Cayman, Condor	97→	B7HS	5110			BR7HIX	7067	0.6

MASAI									
265	A300	05→	DCPR7E	3932	DCPR7EVX	1179	DCPR7EIX	6046	0.8
450	A450	05→	DCPR8E*	4179			DCR8EIX	3606	0.6

MASSEY FERGUSON									
250	MF250 2WD	06→08	DR7EA	7839					0.6
350	MF350MRP 4WD Manual 5 Speed	06→08	DR7EA	7839					0.6
400	MF400MRP 4WD Manual 5 Speed	06→08	CR6E	6965					0.8
450	MF450MRP 4WD Automatic	06→08	CR6E	6965					0.8
500	MF500MRP 4WD Automatic & Manual 5 Speed	06→08	CR6E	6965					0.8
	MF500TBX 4WD Automatic	06→08	CR6E	6965					0.8

MOTO ROMA									
50	Blazer 50		B8HS	5510			BR8HIX	7001	0.5
	Blazer 50DL		BP7HS	5111			BPR7HIX	5944	0.6
90	Sport 90		BP7HS	5111			BPR7HIX	5944	0.7
100	Blazer 100		BP7HS	5111			BPR7HIX	5944	0.5
	Roadrunner 4	04→	BP7HS	5111			BPR7HIX	5944	0.6
	Sport 100		BP7HS	5111			BPR7HIX	5944	0.6
125	Sportsman 125	03→	C7HSA	4629			CR7HIX	7544	0.6
	SS Buggy (AB125E,R)		C7HSA	4629			CR7HIX	7544	0.6
150	DS Buggy (AB150IIR)		C7HSA	4629			CR7HIX	7544	0.6
	Sport/Sportsman 150		C7HSA	4629			CR7HIX	7544	0.6
	X Machine		C7HSA	4629			CR7HIX	7544	0.6
	Sport 250		C7HSA	4629			CR7HIX	7544	0.6
250	Sportsman 250		C7HSA	4629			CR7HIX	7544	0.6
	Geko 300	05→	DR8EA	7162	DR8EVX	6354	DR8EIX	6681	0.7

POLARIS									
50	Predator 50	03→	BPR7HS	6422			BPR7HIX	5944	0.6
90	Predator 90	03→	BPR7HS	6422			BPR7HIX	5944	0.6
	Sportsman 90		BPR7HS	6422			BPR7HIX	5944	0.6
200	Phoenix 200	05→	CR6HSA	2983			CR6HIX	7274	0.7
	Sawtooth	06→	CR7HSA	4549			CR7HIX	7544	0.7
250	Trail Blazer 250		BR8ES	5422			BR8EIX	5044	0.7
300	Hawkeye 300 2x4, 4x4	06→	CR8EB	7784			CR8EIX	4218	0.8
330	Magnum 330		BKR6E	6962			BKR6EIX	6418	0.9
	Trail Boss 330		BKR6E	6962			BKR6EIX	6418	0.9
400	Sportsman 400 H.O.	09→	BKR6E	6962			BKR6EIX	6418	0.9
450	Sportsman 450		BKR6E	6962			BKR6EIX	6418	0.9
500	Predator 500	05→	DCPR8E*	4339			DCR8EIX	3606	0.9
	Predator Troy Lee	06→	DCPR8E*	4339			DCR8EIX	3606	0.9
	Ranger 4x4 EFI		BKR6E	6962			BKR6EIX	6418	0.9
	Scrambler 500		BKR6E	6962			BKR6EIX	6418	0.9
	Sportsman 500 EFI		BKR6E	6962			BKR6EIX	6418	0.9
	Sportsman 500 H.O. EFI (Incl. Touring)	09→	BKR6E	6962			BKR6EIX	6418	0.9
650	Ranger TM	06→	BPR5ES	7422			BPR5EIX	6597	0.9
680	Ranger 6x6 EFI		BKR7E	6097	BKR7EVX	3544	BKR7EIX	2667	0.9
	Ranger XP		BKR7E	6097	BKR7EVX	3544	BKR7EIX	2667	0.9
700	Sportsman 700 EFI		BKR7E	6097	BKR7EVX	3544	BKR7EIX	2667	0.9
	Sportsman 700 Twin		BKR7E	6097	BKR7EVX	3544	BKR7EIX	2667	0.9
800	Sportsman 800 EFI		BKR7E	6097	BKR7EVX	3544	BKR7EIX	2667	0.9
850	Sportsman XP 850	→09	LKAR8A-9	4786					0.9



* Please note DCPR8E 4339 has a removable terminal nut, whereas DCPR8E 4179 has a fixed terminal nut





CC	MODEL	DATE	STANDARD COPPER CORE	STOCK NUMBER	PLATINUM OR GOLD PALLADIUM	STOCK NUMBER	IRIDIUM	STOCK NUMBER	GAP MM
QUADZILLA									
50	Buzz	03→07	BPR7HS	6422			BPR7HIX	5944	0.6
100	M100		BP7HS	5111			BPR7HIX	5944	0.7
	ProShark	04→	BP8ES	2912	BP8EVX	2671	BPR8EIX	6684	0.6
	ProShark E		BR8HSA	5539			BPR8HIX	6742	0.6
	ProShark Type R		BP8ES	2912	BP8EVX	2671	BPR8EIX	6684	0.6
	R100		BPR7HS	6422			BPR7HIX	5944	0.6
	X100 Single piece head (12.7mm Thread Reach)		BR8HSA	5539			BPR8HIX	6742	0.6
	X100 Twin piece head (19mm Thread Reach)		BP8ES	2912	BP8EVX	2671	BPR8EIX	6684	0.6
165	R170E Stinger	03→06	DR8EA	7162	DR8EVX	6354	DR8EIX	6681	0.7
200	200E 4 Cross		DR8EA	7162	DR8EVX	6354	DR8EIX	6681	0.7
	ST200E	06→07	CR7HSA	4549			CR7HIX	7544	0.6
250	PGO 250E Bugrider		DPR7EA-9	5129			DPR7EIX-9	7803	0.9
	R250E Stinger		CR8HS	7423	CR8HVX	7236	CR8HIX	7669	0.7
	R250E Triple Disc		CR8HS	7423	CR8HVX	7236	CR8HIX	7669	0.7
	XRV 250	06→07	DPR7EA-9	5129			DPR7EIX-9	7803	0.9
300	300E SUV 4 Valve		DR8EA	7162	DR8EVX	6354	DR8EIX	6681	0.7
500	XLC500	08→	DCPR8E*	4339			DCR8EIX	3606	0.9
700	RS7	10→	CR6E	6965					0.8
750	RS8	11→	CR6E	6965					0.8

QUANTUM									
150	Dingo, Falcon		C7HSA	4629			CR7HIX	7544	0.6
500	NF500L		BKR6E	6962			BKR6EIX	6418	0.7

SKYTEAM									
50	LX50ST-C		CR7HSA	4549			CR7HIX	7544	0.6
200	ST200 Quad		DR8EA	7162	DR8EVX	6354	DR8EIX	6681	0.7

SUZUKI									
50	LT50 →K4/K5 (Ø14mm Plug)	→05	BPR4HS	7823					0.7
	LT-A50 →K4/K5 (Ø14mm Plug)	→05	BPR4HS	7823					0.7
	LT-Z50 K5/K6 (Ø10mm Plug)	05→	CR6HSA	2983			CR6HIX	7274	0.7
80	LT80 P-R-S		BP7HS	5111			BPR7HIX	5944	0.7
	LT80 T-V-W-X-Y K1-K5		BPR7HS	6422			BPR7HIX	5944	0.7
90	LT-Z90	06→	CR6HSA	2983			CR6HIX	7274	0.7
250	LT-4WD	87→98	DR7ES	3123					0.7
	LT-F250F Ozark	99→02	DR7EA	7839					0.6
	LT-F250	03→	DR7EA	7839					0.6
	LT-Z250 K4-K5	04→	DR7EA	7839					0.6
300	LT-F300F	99→02	DR7EA	7839					0.7
400	LT-A400F K2 (Eiger)	02→	CR7E	4578			CR7EIX	7385	0.7
	LT-F400 Eiger 2WD		CR7E	4578			CR7EIX	7385	0.7
	LT-F400F Eiger 4WD	02→09	CR7E	4578			CR7EIX	7385	0.7
	LT-F400FSi KingQuad	10→	CR7E	4578			CR7EIX	7385	0.7
	LT-Z400	03→	CR7E	4578			CR7EIX	7385	0.7
450	LT-A450X	07→	CR6E	6965					0.8
	LT-R450	06→	CR8EB	7784			CR8EIX	4218	0.7
500	LT-A500XP KingQuad	10→	CR6E	6965					0.8
	LT-F500F	98→07	CR7E	4578			CR7EIX	7385	0.7
700	LT700A K5	05→	CR6E	6965					0.8
	LT-A700X K7	07→	CR6E	6965					0.8
722	LT-A750X	08→	CR6E	6965					0.8

SYM									
200	TrackRunner 200	06→	CR8HSA	2086	CR8HVX	7236	CR8HIX	7669	0.6
250	QuadLander 250	06→	BR8HSA	5539			BPR8HIX	6742	0.6



* Please note DCPR8E 4339 has a removable terminal nut, whereas DCPR8E 4179 has a fixed terminal nut



ATV Quad



CC	MODEL	DATE	STANDARD COPPER CORE	STOCK NUMBER	PLATINUM OR GOLD PALLADIUM	STOCK NUMBER	IRIDIUM	STOCK NUMBER	GAP MM
TGB									
90	Hornet 90		BPR7HS	6422			BPR7HIX	5944	0.6
250	Blade 250		CR8E	1275			CR8EIX	4218	0.8
287	Blade 325 SL 2WD		CR8E	1275			CR8EIX	4218	0.8
	Target 325 SL 2WD		CR8E	1275			CR8EIX	4218	0.8
403	Blade 425 SL 4WD	10→	CR7E	4578			CR7EIX	7385	0.7
	Blade 450 SE IRS 4WD	10→	CR7E	4578			CR7EIX	7385	0.7
460	Blade 460 R 2WD	12→	CR7E	4578			CR7EIX	7385	0.7
503	Blade 550 LT 4WD	11→	CR7E	4578			CR7EIX	7385	0.7
	Blade 550 SE IRS 4WD	11→	CR7E	4578			CR7EIX	7385	0.7
	Target 550 IRS 4WD	11→	CR7E	4578			CR7EIX	7385	0.7

YAMAHA									
50	YFM50 Mini Raptor	03→05	CR7HS	7223			CR7HIX	7544	0.6
	YFM50 Mini Raptor	06→	CR7HSA	4549			CR7HIX	7544	0.7
60	YT60L (Tri-Moto)		BP6HS	4511			BPR6HIX	4085	0.6
80	YFM80	92→03	CR7HS	7223			CR7HIX	7544	0.7
	YFM80 Badger	04→	CR7HSA	4549			CR7HIX	7544	0.7
	YFM80 Raptor	06→	CR7HSA	4549			CR7HIX	7544	0.7
125	YFA1 Breeze	90→03	CR7HS	7223			CR7HIX	7544	0.7
	YFA1 Breeze	04→	CR7HSA	4549			CR7HIX	7544	0.7
	YFM125S Grizzly	04→	CR7HSA	4549			CR7HIX	7544	0.7
200	YTM200EL Yamahauler	1984	D7EA	7912					0.7
	YFM200N (Moto-4)	85→90	D7EA	7912					0.6
	YFS200 Blaster	88→	BR8ES	5422			BR8EIX	5044	0.6
	YTM200EK (Tri-Moto)		D7EA	7912					0.6
215	G1A Utility/Golf Kart	79→	BP5HS	4111					0.7
225	YFM225		DR7ES	3123					0.6
230	YFU1 Pro Hauler	89→90	DR7EA	7839					0.7
250	YFB250 Timberwolf 2WD/4WD	92→97	DR7EA	7839					0.6
	YFM250	88→90	DR7EA	7839					0.7
	YFM250X Bear Tracker	99→04	DR7EA	7839					0.7
	YFM250 Bear Tracker	05→	DR7EA	7839					0.6
	YFM250B Bruin/Big Bear	05→	DR7EA	7839					0.6
	YFM250R Raptor	08→	DR7EA	7839					0.6
285	G2A, G5A, G8A, G9A Utility/Golf Kart	85→	BR4ES	1097					0.8
	G3A Utility/Golf Kart	86→	BP5HS	4111					0.7
287	YFM30GB Grizzly	12→	CR8E	1275			CR8EIX	4218	0.8
350	G23A Utility/Golf Kart	03→06	BPR2ES	2264					0.7
	YFM350 Big Bear 2WD		DR8ES-L	2923	DR8EVX	6354	DR8EIX	6681	0.6
	YFM350 Big Bear 4WD	87→93	DR8ES-L	2923	DR8EVX	6354	DR8EIX	6681	0.6
	YFM350 Big Bear 4WD	94→97	DR8EA	7162	DR8EVX	6354	DR8EIX	6681	0.8
	YFM350A, FWA Bruin 2WD/4WD	03→	DR8EA	7162	DR8EVX	6354	DR8EIX	6681	0.8
	YFM350ER	93→95	DR8ES	5423	DR9EVX	6361	DR9EIX	4772	0.7
	YFM350FWB	97→01	DR8EA	7162	DR8EVX	6354	DR8EIX	6681	0.7
	YFM350FX Wolverine	95→99	DR8EA	7162	DR8EVX	6354	DR8EIX	6681	0.7
	YFM350R Raptor	05→	DR8EA	7162	DR8EVX	6354	DR8EIX	6681	0.8
	YFM350U	96→01	DR8EA	7162	DR8EVX	6354	DR8EIX	6681	0.7
	YFM350X Warrior	87→04	DR8EA	7162	DR8EVX	6354	DR8EIX	6681	0.8
	YFZ350 Banshee	87→	BR8ES	5422			BR8EIX	5044	0.6
	360	G27A U-Max Utility/Golf Kart	04→06	BPR2ES	2264				
YDR-A (The DRIVE)		07→	BPR2ES	2264					0.7
400	YFM400 Big Bear Professional Manual	00→06	DR8EA	7162	DR8EVX	6354	DR8EIX	6681	0.7
	YFM400 Big Bear Manual	07→	DR8EA	7162	DR8EVX	6354	DR8EIX	6681	0.7
	YFM400FWE Kodiak	1993	DR8ES-L	2923	DR8EVX	6354	DR8EIX	6681	0.7
	YFM400 Kodiak Manual	94→99	DR8EA	7162	DR8EVX	6354	DR8EIX	6681	0.7
	YFM400 Kodiak Auto	00→05	DR8EA	7162	DR8EVX	6354	DR8EIX	6681	0.7
YFM4FAV Kodiak Auto	2006	DR8EA	7162	DR8EVX	6354	DR8EIX	6681	0.7	
450	YFM450F Kodiak	03→05	DR8EA	7162	DR8EVX	6354	DR8EIX	6681	0.8
	YFM45 Kodiak	2006	DR8EA	7162	DR8EVX	6354	DR8EIX	6681	0.8
	YFM45 Grizzly	07→	DR8EA	7162	DR8EVX	6354	DR8EIX	6681	0.8
	YFM45 Grizzly EPS	10→	DR8EA	7162	DR8EVX	6354	DR8EIX	6681	0.8
	YFZ450	03→	CR8E	1275			CR8EIX	4218	0.8
	YFZ450R	09→	CR8E	1275			CR8EIX	4218	0.8



CC	MODEL	DATE	STANDARD COPPER CORE	STOCK NUMBER	PLATINUM OR GOLD PALLADIUM	STOCK NUMBER	IRIDIUM	STOCK NUMBER	GAP MM
YAMAHA (CONTINUED)									
558	YFM550FWAD Grizzly	08→	LMAR6A-9	5946					0.9
600	YFM600FWA Grizzly	98→01	DPR8EA-9	4929			DPR8EIX-9	2202	0.9
660	YFM660FWA Grizzly	02→	DPR8EA-9	4929			DPR8EIX-9	2202	0.9
	YFM660R Raptor	01→05	DPR8EA-9	4929			DPR8EIX-9	2202	0.9
	YXR660 Rhino	04→07	DPR8EA-9	4929			DPR8EIX-9	2202	0.9
700	YXR70FX Rhino Fi	08→	CPR7EA-9	3901					0.8
	YFM700R Raptor	06→07	CR8E	1275			CR8EIX	4218	0.6
	YFM700 Grizzly Fi (19mm Thread Reach)	07→08	CPR7EA-9	3901					0.9
	YFM700FWAD Grizzly Fi (26.5mm Thread Reach)	09→	LMAR6A-9	5946					0.9

CONVERSION CHART

IMPORTANT:

This chart is furnished as a guide only. Certain design differences may exist between our spark plugs and another manufacturers; heat ratings can also vary. Always refer to the main application data to select the recommended spark plug for specific engines.

AC DELCO	NGK → STOCK No.	AC DELCO	NGK → STOCK No.	AC DELCO	NGK → STOCK No.	AC DELCO	NGK → STOCK No.				
12620540	ILTR5D	5476	B45	B4	3210	FR5LS	BCPR5ES	6130	R44F	BR5HS	3722
40TS	BP7FS	3612	C42-1	B6S	3510	LM46	B4LM	3410	R44LTS	BPR5EFS	2223
41-108	ILTR5D	5476	C42CFS	BP6HS	4511	LM49	B4LM	3410	R44N	BR6ES	4922
41-2XLS	BP7ES	2412	C42CLTS	BP6EFS	3812	M40FFX	B9HS-10	3626	R44NS	BPR5ES	7422
41-4XLS	BP6ES	7811	C42CXLS	BP6ES	7811	M41FF	B8HS	5510	R44S	BP5S	3011
41-932	PTR5D-13	6644	C42LTS	BP6EFS	3812	M41K	B8S	3810	R44T	BPR5FS	4123
41-933	PTR4B-15	5146	C42N	B7ES	1111	M42FF	B7HS	5110	R44TS	BPR5FS	2423
41-983	PZTR5A-15	7862	C42XLS	BP5ES	6511	M42K	B7S	3710	R44TSX	BPR5FS-15	3124
41-993	PTR4B-15	5146	C43	B6S	3510	M43FF	B6HS	4510	R44TX	BR5FS-15	2224
41TS	BP6FS	3512	C43CXLS	BP6ES	7811	M44C	B6S	3510	R44XL	BR6ES	4922
41XL	B9ES	2611	C43L	B6L	3212	M44L	B6L	3212	R44XLS	BPR5ES	7422
41XLS	BP7ES	2412	C43N	B6ES	7310	M45	B4	3210	R44XLSE	ZGR5C	6334
420Z	B4H	4110	C44	B6S	3510	M45FF	B5HS	4210	R44XLSM	ZGR5C	6334
422Z	B5HS	4210	C44N	B6ES	7310	M47	B4	3210	R45NS	BPR5ES	7422
425Z	B6HS	4510	C44NS	BP5ES	6511	MB42K	B6S	3510	R45NSX	BPR5ES-13	3154
42-6FS	BP6HS	4511	C44S	BP5S	3011	MR42K	BR6S	3522	R45S	BP5S	3011
42F	B6HS	4510	C44XL	B6ES	7310	MR43LTS	BPR6EFS	3623	R45T	BR5FS	4123
42FS	BP6HS	4511	C45	B4	3210	MR43T	BR6FS	4323	R45TS	BPR4FS	1127
42TS	BP6FS	3512	C45L	B4L	3112	MR44C	BR6S	3522	R45TSX	BPR4FS-15	2727
42XL	B8ES	2411	C49	B2	3110	MR44T	BR5FS	4123	R45XL	BR6ES	4922
42XLS	BP6ES	7811	C73	G2Z	3320	R41-5TS	BPR6FS	2623	R45XLS	BPR5ES	7422
430Z	B7HS	5110	C75	G2Z	3320	R41CF	BR7HS	4122	R46	BR6S	3522
436XLS	BP9ES	7526	C81	AB8	7909	R41CXL	BR9ES	5722	R46LTS	BPR5EFS	2223
438XL	B8ES	2411	C82	AB7	3010	R41CXLS	BPR7ES	2023	R46N	BR5ES	4722
438XLS	BP8ES	2912	C83	AB7	3010	R41TS	BPR6FS	2623	R46S	BP4	2911
43FS	BP6HS	4511	C83T	A6FS	2210	R42-5LTS	BPR6EFS	3623	R46T	BR5FS	4123
43N	B7ES	1111	C84T	A6FS	2210	R42-5TS	BPR6FS	2623	R46TS	BPR4FS	1127
43TS	BP6FS	3512	C86	AB6	2910	R42-6FS	BPR6HS	7022	R46TSX	BPR4FS-15	2727
43XL	B7ES	1111	C87	AB6	2910	R42CF	BR6HS	3922	R46TX	BR5FS-15	2224
43XLS	BP6ES	7811	C88	AB2	3020	R42CFS	BPR6HS	7022	R46XL	BR5ES	4722
44	B6S	3510	C88L	AB2	3020	R42CLTS	BPR6EFS	3623	R46XLS	BPR4ES	7222
440T	B7FS	3027	CFR1CLS	BCPR7ES	3330	R42CT	BR6FS	4323	R47S	BP4	2911
440XLS	BP8ES	2912	CFR2CLS	BKR6E	6962	R42CTS	BPR6FS	2623	R83CTS	APR6FS	2922
445Z	B8HS	5510	CR42CFS	BPR6FS	2623	R42CXL	BR8ES	5422	R83TS	APR6FS	2922
44F	B5HS	4210	CR42CXLS	BPR6ES	7822	R42CXLS	BPR6ES	7822	R84TS	APR5FS	3122
44FFS	BP5HS	4111	CR42N	BR7ES	5122	R42FS	BPR6HS	7022	R85TS	APR5FS	3122
44N	B6ES	7310	CR43	BR6S	3522	R42LTS	BPR6EFS	3623	S102F	C7HSA	4629
44NS	BP5ES	6511	CR43CXLS	BPR6ES	7822	R42T	BR6FS	4323	S104F	C6HSA	3228
44S	BP5S	3011	CR43K	BR6S	3522	R42TS	BPR6FS	2623	S121F	D8HA	7112
44TS	BP5FS	3412	CR43N	BR6ES	4922	R42TSM	BPR6FS	2623	S121XL	D8EA	2120
44XL	B6ES	7310	CR43TS	BPR5FS-11	2924	R42XL	BR8ES	5422	S122F	D8HA	7112
44XLO	BP5ES	6511	CR43TSM	BPR5FS-11	2924	R42XLS	BPR6ES	7822	S123XL	D7EA	7912
44XLS	BP5ES	6511	CR44N	BR6ES	4922	R42XLSM	ZGR5C	6334	S124FS	D6HA	6512
45	B4	3210	CR44NS	BPR5ES	7422	R43	BR6S	3522	S404XLG	B10EG	3630
45F	B5HS	4210	CR44TS	BPR5FS-11	2924	R43C	BR6S	3522	S408XLG	B9EG	3530
45FFS	BP5HS	4111	CS40	BM7A	6521	R43CFS	BPR6HS	7022	S40F	B9HS	5810
45L	B4L	3112	CS41	BM7A	6521	R43CT	BR6FS	4323	S40FR	BR9HS	4522
45NS	BP5ES	6511	CS41T	BM7F	6421	R43CTS	BPR6FS	2623	S40XLG	B9ECS	7058
45S	BP5S	3011	CS42	BM7A	6521	R43CTS6	BPR6FS	2623	S40XLR	BR8ES	5422
45XL	B6ES	7310	CS42S	BM7A	6521	R43CXL	BR7ES	5122	S41F	B8HS	5510
45XLS	BP5ES	6511	CS42T	BM6F	6221	R43CXLS	BPR6ES	7822	S41FR	BR8HS	4322
46	B4	3210	CS45	BM6A	5921	R43FS	BPR6HS	7022	S41XL	B9ES	2611
46F	B5HS	4210	CS45T	BM6F	6221	R43LTS	BPR6EFS	3623	S41XLG	B8ECS	2821
46FFS	BP5HS	4111	CS49	BM4A	5628	R43N	BR7ES	5122	S41XLR	BR9ES	5722
46N	B5ES	6410	CSR45	BMR6A	7421	R43T	BR6FS	4323	S42	B7S	3710
46S	BP5S	3011	FR2LS	BKR6E	6962	R43TS	BPR6FS	2623	S42F	B7HS	5110
46XL	B5ES	6410	FR2LSK	BKR6E	6962	R43TSK	BPR6FS	2623	S42FR	BR7HS	4122
47XL	B4ES	4129	FR3CLS	BKR5E	7938	R43TSX	BPR6FS	2623	S42XL	B8ES	2411
83CTS	AP6FS	2710	FR3CLS6	BKR5E-11	6953	R43XL	BR7ES	5122	S42XLR	BR8ES	5422
83TS	AP6FS	2710	FR3LM	ZFR5A-11	5084	R43XLS	BPR6ES	7822	S43XL	B7ES	1111
84T	A6FS	2210	FR3LS	BKR5E	7938	R44	BR6S	3522	S43XLR	BR7ES	5122
B4031	B4	3210	FR3LS6	BKR5E-11	6953	R44CF	BR5HS	3722	S44	B6S	3510
B43	B6S	3510	FR3LSK	BKR5E	7938	R44CXL	BR6ES	4922	S44F	B5HS	4210
B44S	BP5S	3011	FR4LE	ZFR4F-11	4043	R44CXLS	BPR5ES	7422	S44XL	B6ES	7310

AC DELCO	NGK → STOCK No.	
S45F	B5HS	4210
S46	B4	3210
S81F	AB8	7909
S82F	AB8	7909
S83F	AB7	3010
S85F	AB6	2910
SB41	B7S	3710
SV41XL	BUE	2322
V40FFK	BUHW-2	5626
V40FFM	BUHW	2622
V40FFS	BUH	2422
VB40FFM	BUHXW-1	5526
VR40FFK	BUZHW-2	2173
VR40FFM	BUZHW	2147

ALFA ROMEO	NGK → STOCK No.	
4644 9690	BKR6EKPA	2513
55182623	FR5CP	6368
55210685	IKR9F8	5756
55217232	ILKAR7D6G	93607
6056 9086	PGR6A	4984
6056 9957	PFR6B	3500
6057 9903	PFR6B	3500
6059 9495	PMR7A	4529
7173 6281	CR7EB	4663
7173 6282	BKR6EKC	2848

ALM	NGK → STOCK No.	
8	BM6A	5921
19	B2LM	1147
ALM 8	BM6A	5921
ALM 19	B2LM	1147

APRILIA	NGK → STOCK No.	
0297542	DR8EA	7162
0297830	BR10EG	3830
0297921	CR8E	1275
0297942	DCPR9E	2641
0297945	R0045J-10	7400
0897055	BR8ES	5422
2BEN000088	BPR8HS	3725
2BEN000181	CPR8E	7411
8122586	DR7EA	7839
8206870	BR7HS	4122
8206871	BR8HS	4322
8550352	CR7E	4578
8600008	BR9ECM	3252

ASTON MARTIN	NGK → STOCK No.	
021-007-0145	C7HSA	4549
048-007-0149	BPR6ES	7822
07-14641	BPR5EIX	6597
07-20987	BPR6EY	6427
07-21106	BPR7EIX	4055
07-21300	BPR8EIX	6684
07-22846	BPR8ES	3923
07-26330	BP6ES	7811
07-38800	BCPR7E	1272
07-70920	BCR8ES	5430

AUDI - see VW GROUP

AUTOLITE	NGK → STOCK No.	
12	BP7FS	3612
13	BP6FS	3512
14	BP6FS	3512
15	BP5FS	3412
23	BPR6FS	2623
24	BPR6FS	2623
25	BPR5FS	2423
26	BPR4FS-15	2727
27	BPR4FS-15	2727
34	AP6FS	2710
43	APR6FS	2922

AUTOLITE	NGK → STOCK No.	
44	APR6FS	2922
45	APR5FS	3122
46	APR5FS	3122
52	BP7ES	2412
53	BP6ES	7811
54	BP6ES	7811
55	BP5ES	6511
56	BP5ES	6511
62	BP7ES	2412
63	BPR6ES	7822
64	BPR6ES	7822
65	BPR5ES	7422
66	BPR5ES	7422
67	BPR4ES	7222
75	BP5S	3011
76	BP5S	3011
77	BP4	2911
85	BP5S	3011
86	BP4	2911
87	BP4	2911
94	BP7EFS	3526
102	BP7EFS	3526
103	BPR6EFS	3623
104	BPR6EFS	3623
105	BPR5EFS	2223
106	BPR5EFS	2223
115	A6FS	2210
117	A6FS	2210
135	B7FS	3027
143	BR6FS	4323
144	BR6FS	4323
145	BR6FS	4323
146	BR5FS	4123
147	BR5FS	4123
166	APR5FS	3122
175	BP5S	3011
203	BPR6FS	2623
215	B6L	3212
216	B6L	3212
217	B4L	3112
218	B4L	3112
235	BM6A	5921
245	BMR6A	7421
253	BM7A	6521
254	BM6A	5921
255	BM6A	5921
258	BM4A	5628
273	BP6HS	4511
274	BP6HS	4511
275	BP5HS	4111
276	BP5HS	4111
283	BPR7HS	6422
284	BPR6HS	7022
292	B8S	3810
294	B6S	3510
295	B4	3210
297	B4	3210
298	B2	3110
302	BR6S	3522
303	BR6S	3522
304	BR6S	3522
306	B4	3210
308	B2	3110
312	B8S	3810
313	B7S	3710
314	B6S	3510
315	B6S	3510
316	B6S	3510
317	B4	3210
318	B2	3110
353	B8S	3810
354	B6S	3510
355	B6S	3510
356	B4	3210

AUTOLITE	NGK → STOCK No.	
357	B4	3210
358	B2	3110
363	BR6S	3522
372	AB8	7909
373	AB7	3010
374	AB7	3010
375	AB6	2910
376	AB6	2910
377	AB6	2910
378	AB6	2910
379	AB2	3020
386	AB6	2910
393	B7ES	1111
394	B6ES	7310
395	B5ES	6410
396	B5ES	6410
397	B5ES	6410
398	B4ES	4129
402	BR8ES	5422
403	BR6ES	4922
404	BR6ES	4922
405	BR5ES	4722
406	BR5ES	4722
411	B9HS	5810
413	B7HS	5110
414	B6HS	4510
415	B5HS	4210
416	B5HS	4210
417	B4H	4110
424	B6HS	4510
425	BR5HS	3722
426	BR5HS	3722
436	B6L	3212
437	B4L	3112
456	B4LM	3410
458	B2LM	1147
483	BR7EFS	1094
494	B6L	3212
495	B6L	3212
497	B4L	3112
517	BP4HS	3611
536	B4H	4110
664	BPR6FS	2623
665	BPR5FS-15	3124
666	BPR4FS-15	2727
667	BPR4FS-15	2727
687	BR5FS-15	2224
723	BPR6FS	2623
724	BPR6FS	2623
725	BPR5FS-11	2924
726	BPR4FS	1127
727	BPR4FS-11	2527
744	APR5FS	3122
746	APR5FS	3122
747	APR5FS	3122
764	BPR6EFS	3623
765	BPR5EFS	2223
766	BPR5EFS	2223
865	BPR5EFS	2223
915	ZGR5C	6334
925	ZGR5C	6334
935	BPR5ES	7422
945	BPR5ES	7422
996	B6L	3212
2413	B10EGP	5224
2414	B10EG	3630
2415	B9EG	3530
2416	B8EG	3430
2417	B7ECS	2528
2585	BPR5ES	7422
2593	B9ES	2611
2594	B9ES	2611
2612	B9ES	2611
2613	B9ES	2611

AUTOLITE	NGK → STOCK No.	
2614	B8ES	2411
2615	B7ES	1111
2616	B6ES	7310
2634	B9HS-10	3626
2635	B8HS	5510
2636	B7HS	5110
2652	B9HS-10	3626
2653	B7HS	5110
2654	B7HS	5110
2655	B6HS	4510
2656	B5HS	4210
2675	B6L	3212
2676	B6L	3212
2695	AB8	7909
2696	AB7	3010
2697	AB6	2910
2715	D8HA	7112
2716	D6HA	6512
2735	D6HA	6512
2755	D8EA	2120
2772	AB8	7909
2775	AB6	2910
2794	C8HSA	6821
2795	C7HSA	4629
2796	C6HSA	3228
2852	BUH	2422
2872	BUHW	2622
2892	BUHX	2522
2932	BUE	2322
2954	BM7F	6421
2956	BM6F	6221
2974	BPM7A	7321
2976	BPMR7A	4626
3013	B7S	3710
3014	B6S	3510
3035	AB6	2910
3036	BPR4FS-15	2727
3055	A6FS	2210
3074	G2Z	3320
3075	G2Z	3320
3116	AB6	2910
3203	BPR6ES	7822
3204	BPR6ES	7822
3205	BPR5ES	7422
3206	BPR5ES	7422
3207	BPR5ES	7422
3225	BP5S	3011
3226	BP5S	3011
3227	BP5S	3011
3243	BPR6EFS	3623
3244	BPR6EFS	3623
3245	BPR5EFS	2223
3246	BPR5EFS	2223
3264	B7FS	3027
3265	BR6FS	4323
3266	BR5FS	4123
3267	BR5FS	4123
3286	APR6FS	2922
3303	BPR6FS	2623
3325	B6L	3212
3327	B4L	3112
3345	BMR7A	4226
3364	BPR6HS	7022
3382	BR6S	3522
3383	BR6S	3522
3384	BR6S	3522
3386	BR6S	3522
3388	BR6S	3522
3423	B8S	3810
3426	BR6S	3522
3462	BR7ES	5122
3463	BR6ES	4922
3464	BR6ES	4922
3465	BR5ES	4722

BOSCH	NGK → STOCK No.	BOSCH	NGK → STOCK No.	BOSCH	NGK → STOCK No.	BOSCH	NGK → STOCK No.
FGR7DQE	BKR6EKUB 3584	FR7LDC +	BKR6EKC 2848	HR10BCX	BPR4FS-11 2527	M5A	AB7 3010
FGR7DQE+	BKR6EKUB 3584	FR7ME	LFR6B 6677	HR10BCY	BPR4FS-15 2727	M5AC	AB7 3010
FGR7DQE0	BKR6EKUB 3584	FR7MPP10	ILFR6B 6481	HR10BX	BPR4FS-11 2527	M7A	AB6 2910
FGR7DQP	BKR6EQUP 3199	FR7NI33	ILFR6B 6481	HR10BY	BPR4FS-15 2727	M7AC	AB7 3010
FGR7DQP+	BKR6EQUP 3199	FR7NPP33	ILZFR6C-K 6645	HR6B	BPR6FS 2623	M8A	AB6 2910
FGR7KQC	BKR6EQUP 3199	FR7SE	LFR6C-11 5788	HR6BC	BPR6FS 2623	M8A0	AB6 2910
FGR7KQE	BKR6EQUP 3199	FR8D+	BKR5E 7938	HR6BP	BPR6FS 2623	M8AC	AB6 2910
FGR7KQE0	BKR6EQUP 3199	FR8D+X	BKR5E-11 6953	HR6D	BPR6EFS 3623	M95T1	AB6 2910
FGR8KQE0	BKR5EQUB 1567	FR8DC	BKR5E 7938	HR6D+	BPR6EFS 3623	M95T5	AB6 2910
FLR8LDCU	BKR5EK 7956	FR8DC+	BKR5E 7938	HR6DC	BPR6EFS 3623	MA145TR7	APR5FS 3122
FLR8LDCU+	BKR5EK 7956	FR8DC0	BKR5E 7938	HR6DC+	BPR6EFS 3623	MA175T1	A6FS 2210
FLR8LDU+	BKR5EK 7956	FR8DCX	BKR5E-11 6953	HR6DP	BPR6EFS 3623	MA175T7	AP6FS 2710
F03DAR	BKR6EK 2288	FR8DCX+	BKR5E-11 6953	HR6DPP33V	ITR6F13 4477	MA200T7	AP6FS 2710
FQR8DE	BKR6EZB 4293	FR8DE	BKR5EZ 7642	HR6DS	BPR6EFS 3623	UR2AS	CR8HS 7423
FQR8LE2	ZFR5F 5165	FR8DPP33	PFR5G-11 2647	HR7D+	BPR6EFS 3623	UR3AS	CR7HS 7223
FQR8LEU2	ZFR5F 5165	FR8DPP33+	PFR5G-11 2647	HR7DC	BPR6EFS 3623	UR4AS	CR6HS 7023
FR5DC	BCPR7ES 3330	FR8DPX	BKR5E-11 6953	HR7DC+	BPR6EFS 3623	UR5	CR7HSA 4549
FR5DC+	BCPR7ES 3330	FR8DS	BKR5EVX 2546	HR7KPP33	PTR6F-13 7569	UR6DC	CPR7EA-9 3901
FR5DCX	BCPR7ES-11 1095	FR8DX	BKR5E-11 6953	HR7KPP33+	PTR6F-13 7569	USR4AC	CMR6H 3367
FR5DP	BCPR7ES 3330	FR8HDC	BKR5EKB-11 3967	HR7MPP	PTR5A-10 5055	USR7AC	CMR6H 3365
FR5DTC	BCPR7ET 2164	FR8HDC+	BKR5EKB-11 3967	HR7MPP+	PTR5A-10 5055	VR5NC	LKAR8A-9 4786
FR5KPP332S	PFR7S8EG 1675	FR8HP	ZFR5F-11 2262	HR7MPP+V	PTR5A-10 5055	VR8SC	LZKAR7A 6799
FR5LDC	BKR7EKC 7354	FR8KC	BKR5EYA-11 2526	HR8A	BR5FS 4123	VR8SC+	LZKAR7A 6799
FR6D+	BKR6ES 3783	FR8KC+	BKR5EYA-11 2526	HR8AC	BR5FS 4123	VR8SE	LZKAR7A 6799
FR6DC	BKR6E 6962	FR8KCU	BKR5EYA-11 2526	HR8ACY	BR5FS-15 2224	VR8SEW	LZKAR7A 6799
FR6DC+	BKR6E 6962	FR8KTC	BKUR5ET-10 7553	HR8AP	BR5FS 4123	W06AS	B10HVX 2940
FR6DC2	BKR6E 6962	FR8KTC+	BKUR5ET-10 7553	HR8APY	BR5FS-15 2224	W06CS	B11EGV 5831
FR6DCX	BCPR6ES-11 7121	FR8KTCR	BKUR5ET 2789	HR8AY	BR5FS-15 2224	W07AS	B10HVX 2940
FR6DDC	BKR7EKC-N 2095	FR8LCX	ZFR6F-11 4291	HR8B	BPR5FS 2423	W07CS	B10EGV 5927
FR6DP	BKR6EP-8 2215	FR8LDC	BKR5EK 7956	HR8BC	BPR5FS 2423	W08AS	BR9HIX 5687
FR6DP1X	BKR6EP-11 2978	FR8ME	LFR5B 7113	HR8BCY	BPR5FS-15 3124	W08CS	B10EGV 5927
FR6DPP332	PFR6B 3500	FR8SC	LFR6B 6677	HR8BP	BPR5FS 2423	W10A	B4H 4110
FR6DPX	BCPR6ES-11 7121	FR8SC+	LFR6B 6677	HR8BPX	BPR5FS-11 2924	W10AC	B4H 4110
FR6DTC	BCPR6ET 2197	FR8SE0	LFR6B 6677	HR8BPY	BPR5FS-15 3124	W10C	B4ES 4129
FR6DTCW	BCPR6ET 2197	FR8SPP332	PLFR5A-11 6240	HR8BY	BPR5FS-15 3124	W10CC	B4ES 4129
FR6KDC	BKR6EK 2288	FR9HC	ZFR4F-11 4043	HR8D+	BPR5EFS 2223	W10DC	BPR4ES 7222
FR6KDC+	BKR6EK 2288	FR9LCX	ZFR6V-G 8894	HR8DC+	BPR5EFS 2223	W10E	B4 3210
FR6KPP332S	PFR6Q 6458	H10BC	BPR4FS 1127	HR8MCV	TR5B-13 4559	W10F	BP4 2911
FR6LDC	BKR6EK 2848	H2CS	B9EFS 1085	HR8MCV+	TR5B-13 4559	W10FC	BP4 2911
FR6LTC	BKUR7ET 7873	H3CS	B8EFS 1049	HR8MEV	TR5B-13 4559	W125T1	B4H 4110
FR6MPP10	ILFR6B 6481	H5D	BP7EFS 3526	HR9A	BR5FS 4123	W125T2	B4ES 4129
FR6MPP332	ILFR6A 3588	H5DC	BP7EFS 3526	HR9AC	BR5FS 4123	W125T3	B4 3210
FR7D+	BKR6ES 3783	H5DC0	BP7EFS 3526	HR9ACY	BR5FS-15 2224	W125T30	BP5ES 6511
FR7D+X	BKR6E-11 2756	H5DP	BP7EFS 3526	HR9AP	BR5FS 4123	W125T4	B4H 4110
FR7DC	BKR6E 6962	H6B	BP6FS 3512	HR9APY	BR5FS-15 2224	W125TR2	BR5ES 4722
FR7DC+	BKR6E 6962	H6BC	BP6FS 3512	HR9AY	BR5FS-15 2224	W125TR3	BR6S 3522
FR7DC0	BKR6E 6962	H6D	BP6EFS 3812	HR9B	BPR4FS 1127	W125TR30	BPR5ES 7422
FR7DC2	BKR6E 6962	H6DC	BP6EFS 3812	HR9BC	BPR4FS 1127	W12A	B4H 4110
FR7DC9	BKR6E 6962	H6DC0	BP6EFS 3812	HR9BC+	BPR4FS 1127	W12E	B2 3110
FR7DCX	BCPR6ES-11 7121	H6DP	BP6EFS 3812	HR9BCY	BPR4FS-15 2727	W145T1	B5HS 4210
FR7DCX+	BCPR6ES-11 7121	H7CC	BR6EF 3177	HR9BCY+	BPR4FS-15 2727	W145T1.1	B5HS 4210
FR7DE	BKR6EZ 4619	H7CP	BR6EF 3177	HR9BPX	BPR4FS-11 2527	W145T2	B5ES 6410
FR7DP	BKR6E 6962	H7D	BP6EFS 3812	HR9BPY	BPR4FS-15 2727	W145T3	B6S 3510
FR7DP1X	PFR6B-11 4014	H7DC	BP6EFS 3812	HR9BY	BPR4FS-15 2727	W145T30	BP5ES 6511
FR7DPP+	PFR6B 3500	H7DC0	BP6EFS 3812	HR9D	BPR5EFS 2223	W145T35	BP5HS 4111
FR7DPP10	BKR6EIX 6418	H7DP	BP6EFS 3812	HR9DC	BPR5EFS 2223	W145TR2	BR5ES 4722
FR7DPP22U	PFR6N-11 3546	H8B	BP5FS 3412	HS5E	BM7F 6421	W145TR3	BR6S 3522
FR7DPP33	PFR6Q 6458	H8BC	BP5FS 3412	HS8E	BM6F 6221	W145TR30	BPR5ES 7422
FR7DPX	BKR6E-11 2756	H8BP	BP5FS 3412	M10A	AB6 2910	W175T1	B6HS 4510
FR7DTC	BCPR6ET 2197	H8DC	BP5EFS 3712	M10A0	AB6 2910	W175T2	B6ES 7310
FR7HE02	ZFR6T-11G 5960	H8DC0	BP5EFS 3712	M10AC	AB6 2910	W175T3	B6S 3510
FR7HPP332	PZFR5N-11T 7742	H8DP	BP5EFS 3712	M10ACO	AB6 2910	W175T30	BP6ES 7811
FR7KC	BKR5EYA 2087	H9BC	BPR4FS 1127	M12B	AB6 2910	W175T35	BP6HS 4511
FR7KC+	BKR5EYA 2087	H9BCY	BPR4FS-15 2727	M145T1	AB6 2910	W175TR1	BR6HS 3922
FR7KCW	BKR5EYA 2087	H9DC	BP5EFS 3712	M145T5	AB6 2910	W175TR30	BPR6ES 7822
FR7KDC	BKR6EK 2848	H9DC0	BP5EFS 3712	M175T1	AB6 2910	W175Z1	B6HS 4510
FR7KPP332	IZFR6H11 4294	H9HP	BP5EFS 3712	M225T1	AB7 3010	W200T30	BP6ES 7811
FR7KTC	BKUR6ET-10 2397	HLR8STEX	LTR6B-10T 5948	M240T1	AB7 3010	W200T35	BP6HS 4511
FR7LC2	BKR6E 6962	HR10A	BR5FS 4123	M280T1	AB8 7909	W200TR30	BPR6ES 7822
FR7LCX	ZFR6F-11 4291	HR10AC	BR5FS 4123	M45T1	AB6 2910	W215T30	BP6ES 7811
FR7LCX+	ZFR6F-11 4291	HR10ACY	BR5FS-15 2224	M4A	AB7 3010	W225T1	B7HS 5110
FR7LD	BKR6EK 2288	HR10AY	BR5FS-15 2224	M4A1	AB8 7909	W225T2	B7ES 1111
FR7LD+	BKR6EK 2288	HR10B	BPR4FS 1127	M4A2	AB7 3010	W225T3	B7S 3710
FR7LDC	BKR6EK 2848	HR10BC	BPR4FS 1127	M4AC	AB7 3010	W225T35	BP7HS 5111

BOSCH	NGK → STOCK No.		BOSCH	NGK → STOCK No.		BOSCH	NGK → STOCK No.		BOSCH	NGK → STOCK No.	
W225TR30	BPR7ES	2023	W5AP	B7HS	5110	W8EC	B6S	3510	WR6DCX	BPR6ES-11	4824
W230T30	BP7ES	2412	W5AS	BR7HIX	7067	W8F	BP5S	3011	WR6DP	BPR6ES	7822
W240M1	B8HS	5510	W5B	BP7HS	5111	W8FC	BP5S	3011	WR6DPX	BPR6ES-11	4824
W240MZ1	B8HS	5510	W5BC	BP7HS	5111	W8LCR	ZGR5A	5839	WR6DS	BPR6EIX	6637
W240T1	B8HS	5510	W5BP	BP7HS	5111	W8LDCR	BUR6ET	3172	WR6DTC	BP6ET	1263
W240T2	B8ES	2411	W5C	B7ES	1111	W8LPR	ZGR5A	5839	WR7A	BR6HS	3922
W240T3	B7S	3710	W5CC	B7ES	1111	W8LTCR	BUR5ET	3377	WR7AC	BR6HS	3922
W250P21	BP7ES	2412	W5CP	B7ES	1111	W95T1	B4H	4110	WR7B	BPR6HS	7022
W250T1	B8HS	5510	W5CS	BR7EIX	6664	W95T2	B4ES	4129	WR7B+	BPR6HS	7022
W250T2	B8ES	2411	W5D1	BP7ES	2412	W95T3	B4	3210	WR7BC	BPR6HS	7022
W255T30	BP7ES	2412	W5DC	BP7ES	2412	W95T6	BP4	2911	WR7BC+	BPR6HS	7022
W260M1	B8HS	5510	W5DCO	BP7ES	2412	W9A	B4H	4110	WR7BP	BPR6HS	7022
W260MZ1	B8HS	5510	W5DP	BP7ES	2412	W9AO	B4H	4110	WR7C	BR6ES	4922
W260MZ2	B9ES	2611	W5DPO	BP7EIX	4055	W9AC	B5HS	4210	WR7CC	BR6ES	4922
W260S1S	B8HVX	2634	W5DTC	BP6ET	1263	W9ACO	B5HS	4210	WR7CP	BR6ES	4922
W260S1S	BR8HIX	7001	W5E	B7S	3710	W9C	B4ES	4129	WR7D	BPR6ES	7822
W260T1	B8HS	5510	W5EC	B7S	3710	W9CC	B4ES	4129	WR7D+	BPR6ES	7822
W260T2	B9ES	2611	W5EP	B7S	3710	W9D	BP5ES	6511	WR7DC	BPR6ES	7822
W260T20	B8ES	2411	W6B	BP6HS	4511	W9DC	BP5ES	6511	WR7DC+	BPR6ES	7822
W275T1	B8HS	5510	W6BC	BP6HS	4511	W9DP	BP5ES	6511	WR7DCX	BPR6ES-11	4824
W275T2	B9ES	2611	W6BP	BP6HS	4511	W9DTC	BP5ET	2287	WR7DCX+	BPR6ES-11	4824
W280MZ1	B8HS	5510	W6D	BP6ES	7811	W9E	B4	3210	WR7DP	BPR6EIX	6637
W280MZ2	B9ES	2611	W6D1	BP6ES	7811	W9EO	B4LM	3410	WR7DS	BPR6EIX	6637
W280S1S	BR9HIX	5687	W6DC	BP6ES	7811	W9EC	B4	3210	WR7LTC	BUR6ET	3172
W280S2S	BR9EIX	3981	W6DCO	BP6ES	7811	W9ECO	B4LM	3410	WR7LTC+	BUR6ET	3172
W280T30	BP8ES	2912	W6DCO	BP6ESZ	7639	W9F	BP5S	3011	WR8AC	BR5HS	3722
W2A	B9HS	5810	W6DP	BPR6EIX	6637	W9FC	BP5S	3011	WR8B+	BPR5HS	6222
W2AC	B9HS	5810	W6DPO	BPR6EIX	6637	W9LC	ZGR5A	5839	WR8BC+	BPR5HS	6222
W2AP	BR9HIX	5687	W6DPX	BPR6EIX-11	3903	WA125TR30	BPR5EFS	2223	WR8C	BR5ES	4722
W2AS	BR9HIX	5687	W6DTC	BP6ET	1263	WA200T30	BP6EFS	3812	WR8CC	BR5ES	4722
W2CS	BR10EIX	6801	W7A	B6HS	4510	WA200TR30	BPR6EFS	3623	WR8CP	BR5ES	4722
W2D	BP9ES	7526	W7A0	B6HS	4510	WA225T30	BP7EFS	3526	WR8D	BPR5ES	7422
W300T1	B9HS	5810	W7AC	B6HS	4510	WAK145T3	BM6F	6221	WR8D+	BPR5ES	7422
W300T30	BP9ES	7526	W7AP	B6HS	4510	WAK225T3	BM7F	6421	WR8DC	BPR5ES	7422
W310S1S	BR9HIX	5687	W7B	BP6HS	4511	WEA	BUH	2422	WR8DC+	BPR5ES	7422
W310S2S	BR10EIX	6801	W7BC	BP6HS	4511	WEC	BUE	2322	WR8DC0	BPR5ES	7422
W3A	B8HS	5510	W7BP	BP6HS	4511	WET1	BUH	2422	WR8DC4	BPR6ES	7822
W3A0	B8HS	5510	W7C	B6ES	7310	WET2	BUE	2322	WR8DCX	BPR5ES-11	4424
W3AC	B8HS	5510	W7CC	B6ES	7310	WKA145T3	BM6A	5921	WR8DCX+	BPR5ES-11	4424
W3AP	B8HS	5510	W7CCO	B6ES	7310	WKA145T6	BPM6A	7021	WR8DP	BPR5ES	7422
W3AS	B8HVX	2634	W7C	B6ES	7310	WKA175T3	BM6A	5921	WR8DPX	BPR5ES-11	4424
W3AS	BR8HIX	7001	W7CC	B6ES	7310	WKA175T6	BPM6A	7021	WR8E	BR6S	3522
W3C	B9ES	2611	W7CP	B6ES	7310	WKA200TR6	BPMR6A	6726	WR8EC	BR6S	3522
W3CO	B9ES	2611	W7D	BP6ES	7811	WKA225T3	BM7A	6521	WR8EP	BR6S	3522
W3CC	B9ES	2611	W7D0	BP6ES	7811	WKA225T6	BPM7A	7321	WR8F	BP5S	3011
W3CP	B9ES	2611	W7D0	BP6ES	7811	W06CS	B11EGV	5831	WR8FC	BP5S	3011
W3CS	BR9EIX	3981	W7DC	BP6ES	7811	WR10A	BR4HS	3322	WR8FP	BP5S	3011
W3D	BP8ES	2912	W7DCO	BP6ESZ	7639	WR10AC	BR4HS	3322	WR8HP	ZGR5C	6334
W3DP	BP8EVX	2671	W7DCR	BPR6ES	7822	WR10DC	BPR4ES	7222	WR8LC	ZGR5A	5839
W3DP	BPR8EIX	6684	W7DCX	BPR6ES-11	4824	WR10E	BR6S	3522	WR8LC+	ZGR5A	5839
W3DPO	BP8EVX	2671	W7DP	BP6ES	7811	WR10F	BP4	2911	WR8LTC+	BUR5ET	3377
W3DPO	BPR8EIX	6684	W7DTC	BP6ET	1263	WR10FC	BP4	2911	WR9A0	BR5HS	3722
W3DP2	BP8ES	2912	W7E	B6S	3510	WR11E0	BR4LM	4133	WR9C	BR5ES	4722
W45T1	B4H	4110	W7EC	B6S	3510	WR240T1	BR8HS	4322	WR9CC	BR5ES	4722
W4A	B8HS	5510	W7EP	B6S	3510	WR3CC	BR9ES	5722	WR9D	BPR5ES	7422
W4A1	B8HS	5510	W7LTCR	BUR6ET	3172	WR4AC	BR8HS	4322	WR9D+	BPR5ES	7422
W4A2	B8HS	5510	W8A	B5HS	4210	WR4CC	BR8ES	5422	WR9DC	BPR5ES	7422
W4A5	B8HS	5510	W8A0	B5HS	4210	WR4CP	BR8EIX	5044	WR9DC+	BPR5ES	7422
W4AC	B8HS	5510	W8AC	B5HS	4210	WR5A	BR7HS	4122	WR9DP	BPR5ES	7422
W4AP	B8HS	5510	W8AP	B5HS	4210	WR5AC	BR7HS	4122	WR9DPX	BPR5ES-11	4424
W4AS	B8HVX	2634	W8B	BP5HS	4111	WR5BC	BPR7HS	6422	WR9E	BR6S	3522
W4AS	BR8HIX	7001	W8BC	BP5HS	4111	WR5CC	BR7ES	5122	WR9EO	BR6S	3522
W4C	B8ES	2411	W8BP	BP5HS	4111	WR5CP	BR7ES	5122	WR9EC	BR6S	3522
W4C1	B8ES	2411	W8C	B5ES	6410	WR5D	BPR7ES	2023	WR9ECO	BM6	2027
W4C2	B7ES	1111	W8C0	B5ES	6410	WR5D+	BPR7ES	2023	WR9F	BP5S	3011
W4C3	B7HS	5110	W8CC	B5ES	6410	WR5DC	BPR7ES	2023	WR9FC	BP5S	3011
W4CC	B8ES	2411	W8CCX	B5ES	6410	WR5DC+	BPR7ES	2023	WR9FP	BP5S	3011
W4CP	BR8EIX	5044	W8CP	B5ES	6410	WR5DP	BPR7ES	2023	WR9HC	ZGR5C	6334
W4CS	BR8EIX	5044	W8D	BP5ES	6511	WR5DS	BPR7EIX	4055	WR9HP	ZGR5C	6334
W4DP	BPR7EIX	4055	W8DC	BP5ES	6511	WR6BC	BPR6HS	7022	WR9LE	ZGR5A	5839
W4DPO	BPR7EIX	4055	W8DCO	BP5ES	6511	WR6D	BPR6ES	7822	WR9LS	ZGR5A	5839
W4E2	B7S	3710	W8DP	BP5ES	6511	WR6D+	BPR6ES	7822	WS5E	BM7A	6521
W5A	B7HS	5110	W8DTC	BP5ET	2287	WR6DC	BPR6ES	7822	WS5F	BPM7A	7321
W5AC	B7HS	5110	W8E	B6S	3510	WR6DC+	BPR6ES	7822	WS7E	BM6A	5921

BOSCH	NGK → STOCK No.	
WS7F	BPM6A	7021
WS8E	BM6A	5921
WS8F	BPM6A	7021
WSR5F	BPMR7A	4626
WSR6F	BPMR6A	6726
WSR8E	BMR6A	7421
WSR8F	BPMR6A	6726
WSR9E	BMR4A	5728
X3CP0	D9EA	2420
X4CS	D8EA	2120
X5DC	D7EA	7912
XR2AS	DR8HS	5123
XR2CS	DR8ES	5423
XR4AS	DR8HS	5123
XR4CS	DR8ES	5423
XR5DC	DR7EA	7839
Y6NPP332	PLKR7B8E	94716
Y7MPP33	PLKR7A	4288
YR6LDE	DCPR8EKC	7168
YR6NPP332	PLKR7B8E	94716
YR7DC	DCPR7E-N-10	4983
YR7DC+	DCPR7E-N-10	4983
YR7DE	DCPR8E-N	5692
YR7LPP332W	IZKR7B	7563
YR7MPP33	PLKR7A	4288
ZQR8S1302	PLZKBR7A-G	5843

BRIGGS & STRATTON	NGK → STOCK No.	
BS19LM	B2LM	1147
BS19LMR	BR2LM	5798
BS-SV	BR2LM	5798
BS-OHV	BCPR5ES	6130
BS-OHV-HT	BCPR5ES	6130
491043	BCPR5ES	6130
491055E	BCPR5ES	6130
491055S	BCPR5ES	6130
492167	BR2LM	5798
496018E	BCPR5ES	6130
496018S	BCPR5ES	6130
6093E	BCPR5ES	6130
6099E	BR2LM	5798
696202	BKR5EVX	2546
697451	BR2LM	5798
711252	BCPR5ES	6130
799876	BPMR6A	6726
802592S	BR2LM	1147
992039	BR2LM	5798
992041	BR2LM	5798
992300	BR2LM	5798
992301	BR2LM	5798
992302	BR2LM	5798
992304	BCPR5ES	6130
992305	BCPR5ES	6130
992306	BCPR5ES	6130

BRISK	NGK → STOCK No.	
77-300-1	BPM7A	7321
77-305-1	BR2LM	5798
77-307-1	BPMR7A	4626
77-312-1	BPR6ES	7822
B14YC	DPR8EA-9	4929
D12YC	BCP7ES	5030
D14Y	BKR6E	6962
D14YC	BCP7ES	5030
D15Y	BKR6E	6962
D15YC	BCP6ES	4930
D17Y	BKR5E	7938
D17YC	BCP5ES	7496
DOX15LE	ZFR6T-11G	5960
DR12YC	BKR7E	6097
DR14YC	BCPR7ES	3330
DR14ZC	ZFR7F-11	2975
DR14ZC-1	BCPR7ES-11	1095
DR15TC	BKUR5ET-10	7553

BRISK	NGK → STOCK No.	
DR15YC	BKR6E	6962
DR15Z	BKR6E	6962
DR15Z-1	BCPR6ES-11	7121
DR17YC	BCPR5ES	6130
F14YC	AP7FS	2127
F15YC	AP6FS	2710
FR14YC	APR6FS	2922
FR15YC	APR6FS	2922
G12YC	BP7EFS	3526
G14Y	BP7EFS	3526
G14YC	BP7EFS	3526
G15Y	BP6EFS	3812
G15YC	BP6EFS	3812
G17Y	BP5EFS	3712
G17YC	BP5EFS	3712
GR15YC	BPR6EFS	3623
GR17YC	BPR5EFS	2223
J17	B4LM	3410
J19	B2LM	1147
JR17	BR4LM	4133
JR19	BR2LM	5798
K17C	B6S	3510
K17Y	BP5S	3011
K19	B4	3210
L08JW	B10EGV	5927
L08W	B11EGV	5831
L10JW	B8EGV	5627
L12W	BR9EIX	3981
L12Y	BP9ES	7526
L12YC	BP9ES	7526
L14	B8ES	2411
L14C	B8ES	2411
L14Y	BP6ES	7811
L14YC	BP7ES	2412
L15	B7ES	1111
L15C	B7ES	1111
L15W	BR8EIX	5044
L15Y	BP6ES	7811
L15YC	BP6ES	7811
L17	B6ES	7310
L17C	B6ES	7310
L17W	BR7EIX	6664
L17Y	BP5ES	6511
L17YC	BP5ES	6511
L19C	B5ES	6410
LR12YC	BPR8ES	3923
LR12ZC	BPR8ES	3923
LR14TXS	BUR6ET	3172
LR14YC	BPR7ES	2023
LR14ZC	BPR7ES	2023
LR14ZC-1	BPR7ES-11	7226
LR15TXS	BP5ET	2287
LR15YC	BPR6ES	7822
LR15Z	BPR6ES	7822
LR15Z-1	BPR6ES-11	4824
LR17YC	BPR5ES	7422
N08W	B10HVX	2940
N12W	BR9HIX	5687
N12Y	BP8HS	2630
N12YC	BP8HS	2630
N14	B8HS	5510
N14C	B9HS	5810
N14Y	BP6HS	4511
N14YC	BP7HS	5111
N15	B6HS	4510
N15C	B7HS	5110
N15W	B8HVX	2634
N15W	BR8HIX	7001
N15Y	BP6HS	4511
N15YC	BP6HS	4511
N17	B5HS	4210
N17C	B6HS	4510
N17W	BR7HIX	7067
N17Y	BP4HS	3611

BRISK	NGK → STOCK No.	
N17YC	BP5HS	4111
N19	B5HS	4210
N19C	B5HS	4210
NR12YC	BPR8HS	3725
NR15YC	BPR6HS	7022
P15	BM7A	6521
P15Y	BPM7A	7321
P17	BM6A	5921
P17Y	BPM6A	7021
PR15Y	BPMR7A	4626
PR17	BMR6A	7421
PR17Y	BPMR6A	6726
U15	BM7F	6421
U17	BM6F	6221

CARLTON	NGK → STOCK No.	
71010	BM7F	6421
71015	BM6F	6221
71020	BM7A	6521
71025	BPM7A	7321
71030	BM7A	6521
71035	BPM7A	7321
71040	BM6A	5921
71045	BPM6A	7021
71050	B6HS	4510
71055	B5HS	4210
71060	B4	3210
71065	B4H	4110
71070	BPMR6A	6726
C10S	B4H	4110
C7S	B6HS	4510
C8S	B5HS	4210
C9	B4	3210
CA5E	BM7A	6521
CA5Y	BPM7A	7321
CA6	BPMR6A	7626
CA7E	BM7A	6521
CA7Y	BPM7A	7321
CA8E	BM6A	5921
CA8Y	BPM6A	7021
CN6E	BM7F	6421
CN8E	BM6F	6221

CHAMPION	NGK → STOCK No.	
2071	BCPR5ES	6130
3071	BKR5EP-11	3440
3401	ITR6F13	4477
4 COM	AB7	3010
5 COM	AB7	3010
7 COM	AB6	2910
8 COM	AB6	2910
860	A6FS	2210
A10	D7EA	7912
A26	AB6	2910
A2HC	DPR9EA-9	5329
A51R	R2525-10	5281
A55C	R2525-10	5281
A55R	R2525-10	5281
A57C	R2525-10	5281
A57G	R2525-10	5281
A57R	R2525-10	5281
A59C	DCR9EIX	6650
A59G	DCR9EIX	6650
A59GC	DCR9EIX	6650
A5YC	DPR9EA-9	5329
A6	D8EA	2120
A61	D9EA	2420
A61G	DR9EIX	4772
A65	AB6	2910
A6G	DR8EIX	6681
A6GC	DR8EIX	6681
A8	D7EA	7912
BL11Y	BP5FS	3412
BL13Y	BP5FS	3412

CHAMPION	NGK → STOCK No.	
BL4	B7FS	3027
BL5	B7FS	3027
BL7Y	BP7FS	3612
BL9Y	BP6FS	3512
BN12Y	BP5EFS	3712
BN2	B9EFS	1085
BN6Y	BP7EFS	3526
BN7Y	BP6EFS	3812
BN89Y	BP6EFS	3812
BN9Y	BP6EFS	3812
C10YCC	BCP6ES	4930
C11YCC	BCP5ES	7496
C12YCC	BKR5E	7938
C281YC	BCP6ES	4930
C53	R7436-10	4900
C55	R7436-10	4900
C55VC	R6601-10	4017
C57	R7436-9	4899
C57C	R7436-9	4899
C57VC	R6601-10	4017
C57Y	BKR9EIX	2669
C57YC	BKR9EIX	2669
C59	R7436-9	4899
C59C	BCR8ES	5430
C59YC	R7435-9	4896
C61	R7436-8	4898
C61C	R7436-8	4898
C6BYC	BCP7ET	2078
C6BYC4	BCP7ET	2078
C6VPYC	BKR7EIX	2667
C6YCC	BCP7ES	5030
C6YCX	BCP7ES	5030
C7	AB6	2910
C7Y	BCP7ES	5030
C7YC	BCP7ES	5030
C7YCC	BCP7ES	5030
C7YCX	BCP7ES	5030
C9MCC	ZFR5F	5165
C9Y	BCP6ES	4930
C9YC	BCP6ES	4930
C9YCC	BCP6ES	4930
C9YCX	BCP6ES	4930
CJ11	BM6A	5921
CJ14	BM4A	5628
CJ17LM	B4LM	3410
CJ3	BM7A	6521
CJ4	BM7A	6521
CJ6	BM7A	6521
CJ7Y	BPM7A	7321
CJ8	BM6A	5921
CJ86	BM6A	5921
CJ8Y	BPM6A	7021
D10	AB6	2910
D14	AB6	2910
D16	AB6	2910
D16J	AB6	2910
D21	AB6	2910
D23	AB6	2910
D6	AB8	7909
D9	AB6	2910
D9J	AB6	2910
D9JM	AB7	3010
DJ6J	BM7F	6421
DJ6Y	BPM7F	1268
DJ7J	BM6F	6221
DJ7Y	BPM6F	5950
DJ8J	BM6F	6221
E82	A7FS	2976
F10	A6FS	2210
F10C	A6FS	2210
F62Y	AP8FS	2227
F7Y	AP7FS	2127
F7YC	AP7FS	2127
F7YCC	AP7FS	2127

CHAMPION	NGK → STOCK No.	CHAMPION	NGK → STOCK No.	CHAMPION	NGK → STOCK No.	CHAMPION	NGK → STOCK No.				
F81Y	AP8FS	2227	L3G	BR8HIX	7001	N54R	B10EGP	5224	OE020	BPR6EFS	3623
F82	A8FS	4489	L4G	BR7HIX	7067	N55G	B105EGV	2171	OE021	BCPR6ET	2197
F83Y	AP8FS	2227	L4J	B7HS	5110	N56R	B105EGP	2077	OE023	BCP6ES	4930
F9Y	AP6FS	2710	L5	B7HS	5110	N57G	B105EGV	2171	OE024	BCPR6ES-11	7121
F9YC	AP6FS	2710	L55G	B10HVX	2940	N57R	B10EGP	5224	OE025	BUR6ET	3172
FN507Y	BCP7ES	5030	L61Y	BP8HS	2630	N59G	B95EGV	2145	OE026	BKR6EK	2288
G1	C9E	7499	L64Y	BP7HS	5111	N5C	B6ES	7310	OE027	BUR5ET-10	7264
G2	C8E	7471	L66Y	BP6HS	4511	N6	B6ES	7310	OE028	BP5ET-10	5156
G54V	R0045J-10	7400	L6G	BR7HIX	7067	N60	B9ES	2611	OE029	PTR5A-10	5055
G55	C9E	7499	L7	B6HS	4510	N60R	B8EGP	2046	OE030	BKR6EKC	2848
G56R	R0373A-10	4940	L76V	BUHW	2622	N62R	B8EGP	2046	OE031	TR5A-10	0005
G58	C9E	7499	L77J	B7HS	5110	N63Y	BP9ES	7526	OE032	BKUR6ET-10	2397
G61	C8E	7471	L77J4	B7HS-10	2129	N64Y	BP8ES	2912	OE033	BKR6EZ	4619
G63	C8E	7471	L77JC	B7HS	5110	N65Y	BP7ES	2412	OE034	BKR6EZ	4619
H03	B6S	3510	L77JC4	B7HS-10	2129	N66Y	BP6ES	7811	OE035	LF5B	7113
H10	B6L	3212	L77V	BUHW	2622	N6BYC	BP6ET	1263	OE036	BP6EFS	3812
H10C	B6L	3212	L78	B7HS	5110	N6GY	BP8EVX	2671	OE037	B6HS	4510
H10J	B6L	3212	L78C	B7HS	5110	N6GY	BPR8EIX	6684	OE038	BP6HS	4511
H11	B4L	3112	L78V	BUHW-2	5626	N6Y	BP8ES	2912	OE039	BCPR6ES-11	7121
H12	B4L	3112	L7J	B6HS	4510	N6YC	BP8ES	2912	OE040	B9ES	2611
H8	B6L	3212	L81	B7HS	5110	N6YCC	BP8ES	2912	OE041	FR5-1	7252
H8C	B6L	3212	L81Y	BP7HS	5111	N7	B7ES	1111	OE042	BPR5ES	7422
H8J	B6L	3212	L82	B6HS	4510	N79Y	BP6ES	7811	OE043	BCPR7ES	3330
J11	B4	3210	L82C	B6HS	4510	N7BMC	BP6ET	1263	OE044	BP6ET	1263
J11C	B4	3210	L82Y	BP6HS	4511	N7BYC	BP6ET	1263	OE045	BPR5ES	7422
J11J	B4	3210	L82YC	BP6HS	4511	N7GY	BPR7EIX	4055	OE046	BP7ES	2412
J11Y	BP5S	3011	L82YCC	BP6HS	4511	N7Y	BP7ES	2412	OE047	BPR6ES-11	4824
J12J	B2	3110	L85	B6HS	4510	N7YC	BP7ES	2412	OE048	BPR6ES-11	4824
J12Y	BP5S	3011	L85Y	BP6HS	4511	N7YCC	BP7ES	2412	OE049	BPR5ES-11	4424
J12YC	BP5S	3011	L86	B6HS	4510	N7YCX	BP7ES	2412	OE050	BP7EFS	3526
J13Y	BP5S	3011	L86C	B6HS	4510	N8	B6ES	7310	OE051	BPR5ES	7422
J14J	B2	3110	L86CC	B6HS	4510	N80	B10EG	3630	OE052	DCPR8E-N	5692
J14Y	BP5S	3011	L87C	B6HS	4510	N80G	B11EGV	5831	OE053	APR6FS	2922
J14YC	BP5S	3011	L87Y	BP6HS	4511	N82	B10EG	3630	OE054	APR6FS	2922
J17LM	B4LM	3410	L87YC	BP6HS	4511	N82G	B105EGV	2171	OE055	BP5ES	6511
J18Y	BP4	2911	L87YCC	BP6HS	4511	N84	B9EG	3530	OE056	BKR7E-11	1283
J18YC	BP4	2911	L89CM	BP5HS	4111	N84G	B95EGV	2145	OE057	BCP5ES	7496
J19LM	B2LM	1147	L90	B5HS	4210	N86	B9EG	3530	OE058	BCP7ES	5030
J4	B7S	3710	L90C	B5HS	4210	N86G	B9EGV	5827	OE059	BP5HS	4111
J4C	B7S	3710	L92Y	BP5HS	4111	N87	B8EG	3430	OE060	ZGR5B	7345
J4J	B7S	3710	L92YC	BP5HS	4111	N87G	B8EGV	5627	OE061	AP7FS	2127
J5	B7S	3710	L95Y	BP4HS	3611	N8B	B6ES	7310	OE062	BKR6E-11	2756
J6	B6S	3510	L9J	B6HS	4510	N8GY	BPR6EIX	6637	OE063	BKR6E-11	2756
J6C	B6S	3510	N10PY	BPR6EIX	6637	N8L	ZGR5C	6334	OE064	BPR6HS	7022
J6J	B6S	3510	N10Y	BP6ES	7811	N8Y	BP6ES	7811	OE065	BP5ES	6511
J7	B6S	3510	N11Y	BP5ES	6511	N9BMC	BPR5EJU	5685	OE067	BP7EFS	3526
J7J	B6S	3510	N11YC	BP5ES	6511	N9BYC	BP6ET	1263	OE068	B8ES	2411
J8	B6S	3510	N11YCC	BP5ES	6511	N9BYC4	BP5ET-10	5156	OE069	BCP6ES	4930
J8C	B6S	3510	N12Y	BP5ES	6511	N9Y	BP6ES	7811	OE070	BP6HS	4511
J8J	B6S	3510	N12YC	BP5ES	6511	N9YC	BP6ES	7811	OE071	BPR6HS	7022
K11	AB6	2910	N12YCC	BP5ES	6511	N9YCC	BP6ES	7811	OE072	BP5EFS	3712
K13	AB6	2910	N13L	ZGR5C	6334	N9YCX	BP6ES	7811	OE073	DCPR9E	2641
K15J	AB6	2910	N13Y	BP5ES	6511	NA10	B8ES	2411	OE074	B6ES	7310
K3G	AB8	7909	N14LY	ZGR5C	6334	NA8	B6ES	7310	OE075	BCP7ES	5030
K5G	AB8	7909	N14Y	BP5ES	6511	OBL9Y	BPR6FS	2623	OE076	BCP7ET	2078
K7	AB8	7909	N19V	BUE	2322	OE001	BP6ES	7811	OE077	BCPR6ET	2197
K8	AB8	7909	N1C	BR10ES	4832	OE002	BKR6E	6962	OE078	BR8EIX	5044
K8G	AB8	7909	N2	B9ES	2611	OE003	BCP6ES	4930	OE079	B7ES	1111
K9	AB7	3010	N21	B4ES	4129	OE004	BPR6ES	7822	OE080	BKR7E-11	1283
KC10PYPB4	PFR5G-11	2647	N279YC	BP7ES	2412	OE005	BKR6E	6962	OE081	BKR6E-11	2756
KC8WYP4	IFR6D10	5344	N281YC	BP6ES	7811	OE006	BPR6ES	7822	OE082	BP7EFS	3526
KC8ZMCC	ZFR5P-G	6893	N288	B5ES	6410	OE007	BP6HS	4511	OE084	BP8ES	2912
KC8ZPYPB4	PZFR5N-11T	7742	N2C	B9ES	2611	OE008	BPR7ES	2023	OE085	BKR5EJU	3964
L10	B6HS	4510	N2C	B9ES	2611	OE009	BP6EFS	3812	OE086	BR6HS	3922
L10S	B6HS	4510	N2G	BR9EIX	3981	OE010	BP7ES	2412	OE087	BP8ES	2912
L11S	B7HS	5110	N3	B8ES	2411	OE011	BPR6EFS	3623	OE088	BCPR6ES	2330
L12Y	BP5HS	4111	N3C	B8ES	2411	OE012	BP6ET	1263	OE089	ZFR6F-11	4291
L14	B4H	4110	N3G	BR8EIX	5044	OE013	BKR5E	7938	OE090	BP7EFS	3526
L15Y	BP4HS	3611	N4	B7ES	1111	OE014	BKR7E	6097	OE091	BR9ES	5722
L19V	BUH	2422	N4C	B7ES	1111	OE015	BP5ES	6511	OE092	CR9E	6263
L20V	BUH	2422	N4G	BR7EIX	6664	OE016	BKR6E	6962	OE093	BKR6ES	3783
L288	B5HS	4210	N4YC	BP9ES	7526	OE017	BCP7ES	5030	OE094	BCPR7ES	3330
L2G	BR9HIX	5687	N5	B6ES	7310	OE018	BPR7ES	2023	OE095	BP6ET	1263
L3G	B8HVX	2634	N52R	B11EGP	2191	OE019	BKR5EK	7956	OE096	B6HS	4510

CHAMPION	NGK → STOCK No.	CHAMPION	NGK → STOCK No.	CHAMPION	NGK → STOCK No.	CHAMPION	NGK → STOCK No.				
OE098	BR7ES	5122	PG4PHP	PMR7A	4259	RBL8	BR6FS	4323	RC9MCC4	ZFR6F-11	4291
OE099	BP5EFS	3712	P-G7C	C7E	5096	RBL9Y	BPR6FS	2623	RC9Y	BKR6E	6962
OE100	BPR5EKU	5685	P-RG7C	CR7E	4578	RBN12Y	BPR5EFS	2223	RC9YC	BKR6E	6962
OE101	BPR5ES-11	4424	P-RZ9HC	CR7HSA	4549	RBN13Y	BPR5EFS	2223	RC9YC4	BCPR6ES-11	7121
OE104	BP6HS	4511	PZ7HC	CR7HSA	4549	RBN14Y	BPR5EFS	2223	RC9YCC	BKR6E	6962
OE106	BP5ES	6511	Q504V	R2349-10	6839	RBN9Y	BPR6EFS	3623	RC9YCC4	BCPR6ES-11	7121
OE107	BPR7ES-11	7226	QC12PEP	PZFR6H	7696	RC10DMC	BKR5EK	7956	RCJ4	BMR7A	4226
OE108	BR8ES	5422	QC12YC	BKR5E	7938	RC10ECC	ZFR6F-11	4291	RCJ501H	BPMR4A	6028
OE109	BP6ES	7811	QC501V	R7434-10	4894	RC10MCC	ZFR6V-G	8894	RCJ6	BMR7A	4226
OE110	BCPR7ES	3330	QC59C	BCR8ES	5430	RC10PYC	BKR6EIX	6418	RCJ6Y	BPMR7A	4626
OE111	BPR6ES	7822	QC9MCC4	ZFR6F-11	4291	RC10PYP4	PFR5J-11	4642	RCJ7Y	BPMR7A	4626
OE112	DR8EIX	6681	QCJ8Y	BPMR6A	6726	RC10PYPB4	PFR5G-11	2647	RCJ8	BMR6A	7421
OE113	BPR6ES-11	4824	QJ19LM	BR2LM	5798	RC10VTYC4	BKUR5ET-10	7553	RCJ8Y	BPMR6A	6726
OE115	FR5-1	7252	QL16V	BUZ8H	7447	RC10WMP2	IZFR5B	4080	RD14	AB6	2910
OE116	BPR8ES	3923	QL76V	BUZHW	2147	RC10WYP4	IFR5N10	7866	RD16	AB6	2910
OE117	BPR7ES-11	7226	QL77CC	BZ7HS-10	3579	RC10YC	BCPR6ES	2330	RD16J	AB6	2910
OE118	BCPR6ET	2197	QL77J4	BZ7HS-10	3579	RC10YC4	BKR6E-11	2756	RD9	AB6	2910
OE119	BKR6E	6962	QL77JC4	BZ7HS-10	3579	RC10YCC	BKR6E	6962	RDJ7J	BMR6F	2144
OE121	BKR5E	7938	QL78C	BZ7HS-10	3579	RC10YCC4	BKR6E-11	2756	RDJ7Y	BPMR6F	1270
OE122	PMR8A	5851	QL78V	BUZHW-2	2173	RC10YCL	BKR5EZ	7642	RDJ8J	BMR6F	2144
OE125	BR9EIX	3981	QL78YC	BPZ7HS-10	1093	RC11PYPB4	PFR6N-11	3546	RE14MCC4	LZTR4A-11	5444
OE126	PFR7B	4853	QL78YC6	BPZ7HS-10	1093	RC12ECC	FR5-1	7252	RE14MCC5	LZTR4A-11	5444
OE127	BKR6E	6962	QL7J5	BR6HS	3922	RC12LC	ZFR5F	5165	RE14PLP5	LZTR5AIX-13	2314
OE128	ZFR5F-11	2262	QL81Y	BPZ7HS-10	1093	RC12LC4	ZFR5F-11	2262	RE7PYC5	PTR5A-10	5055
OE129	BKR7EIX	2667	QL82C	BR6HS	3922	RC12LYC	FR5-1	7252	RE7YCC	TR5A-10	0005
OE130	LZKAR7A	6799	QL82YC	BPR6HS	7022	RC12MC4	ZFR5F-11	2262	REA8MCL	LZKAR7A	6799
OE131	PTR5D-10	3784	QL86	BR6HS	3922	RC12MC5	ZFR5F-11	2262	REC10PYC4	LF5AP-11	4775
OE134	BKR6EP-13	2550	QL86C	BR6HS	3922	RC12MCC4	ZFR5F-11	2262	REC10WYPB4	ILFR6B	6481
OE135	LFR4AP-11	5613	QL87YC	BPR6HS	7022	RC12PYP	BKR6EP-13	2550	REC10YC4	LF5A-11	6376
OE136	PFR6J-11	2743	QN2	BR9ES	5722	RC12YC	BKR5E	7938	REC14PLP5	LZTR5AIX-13	2314
OE137	BKR5E-11	6953	QN2C	BR9ES	5722	RC12YC5	BKR5E-11	6953	REC14PYC	LFR4AP-11	5613
OE138	PFR6N-11	3546	QN2G	BR9EIX	3981	RC12YCC	BKR5E	7938	REC9MCLX	LF5B	7113
OE141	BKR6EIX	6418	QN3	BR8ES	5422	RC12YCC4	BKR5E-11	6953	REC9YCL	LFR5B	7113
OE143	PFR6G-9	4377	QN3C	BR8ES	5422	RC14YC	BKR5E	7938	RER8MC	LZKR6B-10E	1578
OE144	BKR6EIX	6418	QN84	BR9EG	3230	RC61YC	BCR8ES	5430	RER8YC	LKR6D-10E	96569
OE145	BKR6EIX	6418	QN86	BR8EG	3130	RC6PYP	PFR7B	4853	RES9PYP4	PTR5A-10	5055
OE146	PFR6N-11	3546	R10	D6EA	7512	RC6VPYC	BKR7EIX	2667	RES9YCC4	TR5A-10	0005
OE147	ZFR6F-11	4291	R54G	R217-11	1072	RC6YC	BCPR7ES	3330	RF11Y	APR6FS	2922
OE148	LFR5A-11	6376	R6	D8EA	2120	RC6YCC	BCPR7ES	3330	RF11YC	APR6FS	2922
OE150	PMR8A	5851	R6G	DR8EIX	6681	RC78PYP	PFR7G-11S	7772	RF14Y	APR5FS	3122
OE151	BPR5EFS	2223	R8	D7EA	7912	RC7BMC	BCPR6ET	2197	RF7YC	APR6FS	2922
OE152	BKR6E-11	2756	RA2HC	DPR9EA-9	5329	RC7BYC4	BCPR6ET	2197	RF7YCC	APR6FS	2922
OE154	ZFR5F-11	2262	RA4HC	DCPR8E	4339	RC7GYC	BKR7EIX	2667	RF9Y	APR6FS	2922
OE155	APR6FS	2922	RA4HCC	DCPR8E	4179	RC7PYCB	BKR6EIX	6418	RF9Y5	APR6FS	2922
OE156	ZGR5C	6334	RA4HCX	DCPR8E-N	5692	RC7PYCB4	PFR6B-11	4014	RF9YC	APR6FS	2922
OE157	BCR8ES	5430	RA59GC	DCR9EIX	6650	RC7Y	BCPR7ES	3330	RFN14LY	ZFR4F-11	4043
OE162	BR6ES	4922	RA6	DR8ES-L	2923	RC7YC	BCPR7ES	3330	RG2PHP	CR8EIX	4218
OE163	LZTR4A-11	5444	RA6HC	DCPR8E	4339	RC7YCC	BCPR7ES	3330	RG4HC	CR9EB	6955
OE167	LZTR5AIX-13	2314	RA6Y	DPR8EA-9	4929	RC7YCC4	BKR7E-11	1283	RG4PHP	PMR8A	5851
OE171	BPR6FS	2623	RA6YC	DPR8EA-9	4929	RC87YCC	BKR7E-11	1283	RG6PP	PMR8A	5851
OE175	LFR5AP-11	4775	RA7YC	DCPR8E	4339	RC87LYC	BKR6E	6962	RG6YC	CPR8E	7411
OE176	PZFR5D-11	7968	RA8HC	DCPR7E	3932	RC87PYC	BKR6EIX	6418	RG6YCA	CPR8E	7411
OE178	LFR5B	7113	RA8Y	DPR7EA-9	5129	RC87YCC	BKR6ES	3783	RG6YCH	CPR8E	7411
OE179	IFR6J11	7658	RA8YC	DPR7EA-9	5129	RC87YCL	BKR6EZ	4619	RG92C	CR9E	6263
OE181	IFR6D10	5344	RA8YCX4	DCPR7E-N-11	4983	RC89PYC	BKR6EIX	6418	RG92DC	CR9EK	4548
OE182	IFR6T11	4589	RAX92C	DR9EA	3437	RC89WYP4	IFR6T11	4589	RG94C	CR8E	1275
OE183	ITR6F13	4477	RAX92DC	JR9C	6193	RC89YCC	BKR6ES	3783	RGU92C	CR9EH-9	7502
OE184	IZFR5B	4080	RAX92YC	DPR9EA-9	5329	RC8BYC	BKR6EKC	2848	RGU94C	CR8EH-9	5666
OE185	IZFR6B	3116	RAX94C	DR8EA	7162	RC8DMC	BKR6EK	2288	RH10C	B6L	3212
OE186	DCPR7E-N-10	4983	RAX94YC	DPR8EA-9	4929	RC8PYCB	PFR6G-9	4377	RH-18Y	B-4L	3112
OE188	IFR6T11	4589	RAX96C	DR7EA	7839	RC8PYP	PFR6J-11	2743	RJ11	BR6S	3522
OE190	ILFR6B	6481	RAX96YC	DPR7EA-9	5129	RC8PYPB4	PFR6N-11	3546	RJ11Y	BP5S	3011
OE191	IFR6D10	5344	RBL11Y	BPR5FS	2423	RC8PYX	BKR6EIX	6418	RJ12	BR6S	3522
OE195	IGR7A	6687	RBL11Y6	BPR5FS-15	3124	RC8VTYC4	BKUR6ET-10	2397	RJ12C	BR6S	3522
OE199	DCPR8E	4339	RBL12	BR5FS	4123	RC8WMP2	IZFR6B	3116	RJ12Y	BP5S	3011
OJ12Y	BP5S	3011	RBL12-6	BR5FS-15	2224	RC8WMP4	IFR6T11	4589	RJ12YC	BP5S	3011
OJ13Y	BP5S	3011	RBL13Y	BPR5FS	2423	RC8WYP4	IFR6J11	7658	RJ14Y	BP5S	3011
ON11Y	BPR5ES	7422	RBL13Y6	BPR5FS-15	3124	RC8YC	BKR6E	6962	RJ14YC	BP5S	3011
ON12Y	BPR5ES	7422	RBL15Y	BPR4FS	1127	RC8YC4	BKR6E-11	2756	RJ17LM	BR4LM	4133
ON3	BR8ES	5422	RBL15Y4	BPR4FS-11	2527	RC8YCC	BKR6E	6962	RJ18Y	BP4	2911
P10Y	D6HA	6512	RBL15Y6	BPR4FS-15	2727	RC8YCC4	BKR6E-11	2756	RJ18YC	BP4	2911
P7	D8HA	7112	RBL16Y	BPR4FS	1127	RC8YCL	BKR6EZ	4619	RJ19LM	BR2LM	5798
P8Y	D6HA	6512	RBL17Y	BPR4FS	1127	RC8BMC	BKR5EKU	3964	RJ2YLE	BPMR6A	6726
PG2PHP	PMR8A	5851	RBL17Y6	BPR4FS-15	2727	RC9MCC4	ZFR5F-11	2262	RJ20Y	BP4	2911

CHAMPION	NGK → STOCK No.	
RJ6	BR6S	3522
RJ6C	BR6S	3522
RJ6J	BR6S	3522
RJ7	BR6S	3522
RJ8	BR6S	3522
RJ8C	BR6S	3522
RJ8J	BR6S	3522
RL12Y	BPR6HS	7022
RL19	BR5HS	3722
RL4J	BR7HS	4122
RL77J	BR7HS	4122
RL78	BR7HS	4122
RL78C	BR7HS	4122
RL7J	BR6HS	3922
RL82	BR6HS	3922
RL82C	BR6HS	3922
RL82Y	BPR6HS	7022
RL82YC	BPR6HS	7022
RL82YCC	BPR6HS	7022
RL85	BR6HS	3922
RL85C	BR6HS	3922
RL86	BR6HS	3922
RL86C	BR6HS	3922
RL87Y	BPR6HS	7022
RL87YC	BPR6HS	7022
RL90	BR5HS	3722
RL95YC	BPR5HS	6222
RN10GY	BPR6EIX	6637
RN10VTYC	BUR5ET	3377
RN10VTYC4	BUR5ET-10	7264
RN10Y	BPR6ES	7822
RN10YC	BPR6ES	7822
RN10Y4	BPR6ES-11	4824
RN11Y	BPR5ES	7422
RN11YC	BPR5ES	7422
RN11YC4	BPR5ES-11	4424
RN11YCC	BPR5ES	7422
RN11YCC4	BPR5ES-11	4424
RN12Y	BPR5ES	7422
RN12YC	BPR5ES	7422
RN12YC4	BPR5ES-11	4424
RN12YC6	BPR5ES-13	3154
RN12YCC	BPR5ES	7422
RN13L	ZGR5C	6334
RN13LYC	ZGR5C	6334
RN14LY	ZGR5C	6334
RN14MC5	BPR5EY-11	3028
RN14PMP5	BPR5EP-11	3971
RN14Y	BPR5ES	7422
RN14Y6	BPR5ES-13	3154
RN14YC	BPR5ES	7422
RN16Y	BPR4ES	7222
RN1C	BR10ES	4832
RN2	BR9ES	5722
RN2C	BR9ES	5722
RN2G	BR9EIX	3981
RN3	BR8ES	5422
RN3C	BR8ES	5422
RN3G	BR8EIX	5044
RN4	BR7ES	5122
RN4C	BR7ES	5122
RN5	BR6ES	4922
RN57YC	BR10EG	3830
RN57YCC	BR10EG	3830
RN5C	BR6ES	4922
RN6	BR6ES	4922
RN6Y	BPR8ES	3923
RN6YC	BPR8ES	3923
RN7GY	BPR7EIX	4055
RN7Y	BPR7ES	2023
RN7YC	BPR7ES	2023
RN7YC4	BPR7ES-11	7226
RN7YCC	BPR7ES	2023
RN7YCC4	BPR7ES-11	7226

CHAMPION	NGK → STOCK No.	
RN8	BR5ES	4722
RN8L	ZGR5C	6334
RN8VTYC4	BUR6ET	3172
RN8WYP	IGR7A	6687
RN9GY	BPR6EIX	6637
RN9LCC	ZGR5B	7345
RN9Y	BPR6ES	7822
RN9YC	BPR6ES	7822
RN9YC4	BPR6ES-11	4824
RN9YCC	BPR6ES	7822
RN9YCC4	BPR6ES-11	4824
RP10HC	DR5HS	4623
RP7	DR8HS	5123
RS12YC	BPR5EFS	2223
RS14YC	BPR5EFS	2223
RS5C	BR7ES	1094
RS8WYP5	ITR6F13	4477
RS9PYP4	PTR5D-10	3784
RS9YC	BPR6EFS	3623
RS9YCC	BPR6EFS	3623
RV12C	BR5FS	4123
RV12C6	BR5FS-15	2224
RV12YC	BPR5FS	2423
RV12YC6	BPR5FS-15	3124
RV15YC	BPR4FS	1127
RV15YC4	BPR4FS-11	2527
RV15YC6	BPR4FS-15	2727
RV17YC	BPR4FS	1127
RV17YC6	BPR4FS-15	2727
RV19YC	BPR4FS	1127
RV8C	BR6FS	4323
RV9YC	BPR6FS	2623
RZ7C	CMR7H	3066
RZ94C	CR8HS	7423
RZ98C	CR6HS	7023
RZN12Y	BPR5EFS	2223
RZN12Y5	BPR5EFS	2223
S10YCC	BP5EFS	3712
S12YC	BP5EFS	3712
S279YC	BP6EFS	3812
S281YC	BP6EFS	3812
S379YC	BP7EFS	3526
S6YC	BP7EFS	3526
S6YCC	BP7EFS	3526
S7YC	BP7EFS	3526
S7YCC	BP7EFS	3526
S9YC	BP6EFS	3812
S9YCC	BP6EFS	3812
UD16	AB6	2910
UF-11Y	APR5FS	3122
UF-14Y	APR5FS	3122
UF-9Y	APR6FS	2922
UJ12	B2	3110
UJ2J	B8S	3810
UJ4J	B7S	3710
UJ6	B6S	3510
UJ8	B6S	3510
UJ81C	B7S	3710
UJ81J	B7S	3710
UK10	AB6	2910
UL17V	BUHXW-1	5526
UL18V	BUHX	2522
UL4J	B7HS	5110
UL77V	BUHXW-1	5526
UL81C	B7HS	5110
UL81J	B7HS	5110
UL12Y	BP5ES	6511
UN19V	BUE	2322
UN79Y	BP6ES	7811
V12YC	BP5FS	3412
V4C	B7FS	3027
V59C	R5673-9	3856
V9YC	BP6FS	3512
XJ4J	B7S	3710

CHAMPION	NGK → STOCK No.	
XJ-8	BR6S	3522
XL-10	BR6HS	3922
XN-8	BR6ES	4922
Y82	CM-6	5812
Z10	C6HSA	3228
Z12	C6HSA	3228
Z6	C8HSA	6821
CHINESE BRANDS NGK → STOCK No.		
A6C	C6HSA	3228
A6RTC	CR6HSA	2983
A6RC	CR6HSA	2983
A6TC	C6HSA	3228
A7C	C7HSA	4629
A7RC	CR7HSA	4549
A7RTC	CR7HSA	4549
A7TC	C7HSA	4629
A8C	C8HSA	6821
A8RC	CR8HSA	2086
A8RTC	CR8HSA	2086
A8TC	C8HSA	6821
B7	C7E	5096
B7R	CR7E	4578
B7RD	CR7EK	7546
B8	C6E	7471
B9	C9E	7499
B9R	CR9E	6263
B9RD	CR9EK	4548
BM6A	BM6A	5921
CMR7H	CMR7H	3066
D7C	D7EA	7912
D7RC	DR7EA	7839
D8C	D8EA	2120
D8RC	DR8EA	7162
D8RTC	DR8EA	7162
D8TC	D8EA	2120
D9C	D9EA	2420
D9RC	DR9EA	3437
DK6RTC	DCPR6E	3481
DK7RTC	DCPR7E	3932
DK8RTC	DCPR8E	4339
E5C	B5HS	4210
E5RC	BR5HS	3722
E5RTC	BPR5HS	6222
E5T	BP5HS	4111
E5TC	BP5HS	4111
E6C	B6HS	4510
E6RC	BR6HS	3922
E6RTC	BPR6HS	7022
E6T	BP6HS	4511
E6TC	BP6HS	4511
E7C	B7HS	5110
E7RC	BR7HS	4122
E7RTC	BPR7HS	6422
E7TC	BP7HS	5111
E8C	B8HS	5510
E8RC	BR8HS	4322
E8RTC	BPR8HS	3725
E8TC	BP8HS	2630
F5TC	BP5ES	6511
F6C	B6ES	7310
F6RC	BR6ES	4922
F6RJY	BUR6ET	3172
F6RTC	BPR6ES	7822
F6TC	BP7ES	2412
F6TJC	BP6ET	1263
F7C	B7ES	1111
F7RC	BR7ES	5122
F7RTC	BPR7ES	2023
F7T	BP7ES	2412
F7TC	BP7ES	2412
F8C	B8ES	2411
F8RC	BR8ES	5422
GL4	B4LM	3410

CHINESE BRANDS NGK → STOCK No.		
K5RF	BKR5E	7938
K5RF-11	BKR5E-11	6953
K5RTC	BKR5E	7938
K5RTC-11	BKR5E-11	6953
K6RF	BKR6E	6962
K6RF-11	BKR6E-11	2756
K6RTC	BKR6E	6962
K6RTC-11	BKR6E-11	2756
L4C	BM4A	5628
L4RTC	BPMR4A	6028
L6C	BM6A	5921
L6RTC	BPMR6A	6726
L6TC	BPM6A	7021
L7C	BM7A	6521
L7RTC	BPMR7A	4626
L7TC	BPM7A	7321
L8RTC	BPMR8Y	2218
LR4C	BMR4A	5728
LR6C	BMR6A	7421
LR7C	BMR7A	4226
T1137C	C7HSA	4629
T4197JC	BP7ES	2412
CHRYSLER GROUP NGK → STOCK No.		
04606402AB	LZTR4A-11	5444
04606591AB	ZFR5LP-13G	7781
SPZFR5LP13G	ZFR5LP-13G	7781
SP000ZFR5N	ZFR5N	7917
SPLZTR5A13	LZTR5AIX-13	2314
CITROEN NGK → STOCK No.		
5960.57	LF6B	6677
5960.F0	BKR6EZ	4619
5960.G1	LZKAR7A	6799
5960.G4	PLZKBR7A-G	5843
59622A	BPR6ES	7822
59622T	BKR6EK	2848
59622X	BKR6E	6962
59625G	BKR6EZ	4619
59627S	BKR6EZ	4619
5962IA	BP5ET	2287
5962IK	BKR6EK	2288
5962IL	BKR5EK	7956
5962OE	BKR6EK	2288
5962S7	BP5ES	6511
5962TO	BKR6E	6962
5962W1	BCPR5ES	6130
5962X8	BCP6ES	4930
5962Z1	BKR6EK	2288
5962Z6	BKR5EK	7956
95496692	BP6HS	4511
95605398	B6HS	4510
95611941	BP6EFS	3812
95619043	BP6ES	7811
96000090	BCP5ES	7496
96037952	BCP5ES	7496
96039962	BCP6ET	4563
96064890	BCPR5ES	6130
96097486	BCP7ET	2078
96145071	BCPR6ET	2197
97533994	BP7EFS	3526
AM212207A	B6HS	4510
MKP00073	BP7ES	2412
ZC9862090U	BP5ES	6511
ZCT000011	BP6HS	4511
ZCT000012	BP7ES	2412
DAIHATSU NGK → STOCK No.		
90048-51006-000	B8ES	2411
90048-51008-000	B7ES	1111
90048-51015-000	B6ES	7310
90048-51020-000	B4H	4110
90048-51022-000	B6HS	4510
90048-51033-000	B5ES	6410

DAIHATSU	NGK → STOCK No.	DENSO	NGK → STOCK No.	DENSO	NGK → STOCK No.	DENSO	NGK → STOCK No.
90048-51034-000	BP6ES 7811	3093	B7ES 1111	3314	DCPR9EVX 6436	4103	D8HA 7112
90048-51034-010	BP6ES 7811	3095	BR7EIX 6664	3314	DCPR9EIX 2316	4105	DR8HS 5123
90048-51047-010	BP5EY 7327	3098	BR7ES 5122	3319	BR8EQ 3328	4106	DPR8Z 4730
90048-51048-000	BPR5EY 2828	3102	BR8ET 4221	3322	BCPR6EP-N-11 4497	4111	DPR9EA-9 5329
90048-51053-000	BP5EY 7327	3103	BR8ET 4221	3324	IFR5T11 4996	4114	D9EA 2420
90048-51054-000	BPR5EY 2828	3107	BR9ET 4528	3329	BKR5EKC 5216	4116	DR8ES 5423
90048-51059-000	BPR6EY 6427	3110	BR5ES 4722	3330	BKUR6ETB-10 5742	4117	DPR9Z 4830
90048-51069-000	BP6EY 7727	3112	ZFR6A-11 1041	3335	IFR6T11 4589	4123	B11EGV 5831
90048-51072-000	BP5ES 6511	3113	BCPR6EP-N-8 5275	3348	ZFR7F-11 2975	4126	CR8E 1275
90048-51077-000	BPR6EKN 1128	3117	BCPR6EP-11 3350	3354	IGR7A 6687	4127	CR8EH-9 5666
90048-51093-000	BPR5EY-11 3028	3119	BKR5EYA 2087	3356	IFR5E11 7994	4128	C9E 7499
90048-51096-000	BPR6ES 7822	3120	BKR5EYA-11 2526	3370	IZFR5G 5887	4129	CR9EH-9 7502
90048-51097-000	BP2ES 3467	3121	BKR6E-11 2756	3372	IFR7G-11KS 7746	4131	CR9E 6263
90048-51100-000	BKR6E-11 2756	3122	BKR6EYA 2249	3373	BKR6EP-8 2215	4135	CR10EK 2360
90048-51104-000	BPR6EKN 1128	3123	BCPR5EP-8 2950	3374	ZFR6K-11 6711	4137	C7E 5096
90048-51105-000	BPR7EKN 7738	3125	BCP6ES 4930	3377	IZFR6K11 6994	4155	CR9EK 4548
90048-51114-000	BPR5ES 7422	3127	BKR6EP-8 2215	3381	LFR6C-11 5788	4158	CR8EK 3478
90048-51118-000	PFR6B-11 4014	3128	BKR6EP-11 2978	3395	IFR5G-11K 3107	4159	BR9ECM 3252
90048-51136-000	BKUR6EK 2213	3130	BKR5E-11 6953	3413	ZFR5F 5165	4160	BR10ECS 5880
90048-51137-000	BKUR6EK 2213	3131	ZFR5F-11 2262	3418	IFR6E11 6741	4161	BPR6HSA 4632
90048-51152-000	BKR6E 6962	3132	ZFR5J-11 5584	3419	IFR7G-11KS 7746	4162	ER9EH 5869
90048-51169-000	BKUR6ETB-10 5742	3133	ZFR6F-11 4291	3427	LZKAR7A 6799	4168	BP7HS-10 7829
90048-51185-000	LFR6C-11 5788	3134	BKR5EP-11 3440	3432	IZFR6K-11S 5266	4169	CR10EIX 6482
90048-51200-000	IKR7D 4759	3135	ZFR5E-11 4435	3439	PLZKAR6A-11 5118	4172	DR9EIX 4772
90919-01061-000	BP5EY 7327	3137	BCPR5E 1145	3443	IFR6G11K 1314	4174	CR7E 4578
90919-01116-000	BPR5EP-11 3971	3139	BKR6EYA-11 4073	3449	IFR6J11 7658	4175	BR8EIX 5044
991-1339-2361-0	AB6 2910	3141	PFR6J-11 2743	3452	IKR6G11 7980	4176	BR10ES 4832
991-2311-2361-00	AB7 3010	3142	PFR6G-11 5555	4002	C6HSA 3228	4178	BP8HS 2630
992-5130-2001-00	B4 3210	3144	BKR6E-N-11 5724	4004	CR6HSA 2983	4185	ER8EH 4011
995-2021-2361-32	B8HS 5510	3145	BKR6E 6962	4006	C7HSA 4629	4186	ER10EH 2862
999-3400-6911-00	BPR6EIX 6637	3146	R7232-9 5516	4008	CR7HSA 4549	4187	CR10E 6264
999-3401-6911-00	BPR5EIX-11 6597	3157	BCPR6EIX 5689	4009	C8HSA 6821	4188	BPR8HS 3725
999-3403-6911-00	BR7EIX 6664	3162	BCPR6EP-11 2978	4010	CR8HS 7423	4189	CR8EIX 4218
999-3407-6911-00	BP5HS 4111	3165	BKR7E 6097	4012	B4H 4110	4191	CR9EIX 3521
999-3409-6911-00	BP6HS 4511	3168	PFR6B-11 4014	4014	BP4HS 3611	4192	BPR5HS 6222
		3169	ZFR6J-11 5585	4017	BR4HS 3322	4196	C8E 7471
		3173	PZFR6F 7550	4018	BPR5EIX-11 6597	4203	CR9EHIX-9 6216
DENSO	NGK → STOCK No.	3174	PFR5J-11 4642	4019	BP5HS 4111	4206	CR8HSA 2086
3004	BPR5EP-11 3971	3176	DCP7E 2363	4021	BP7HS 5111	4222	CR5EH-9 6689
3005	BCPR5EP-11 2097	3178	DCPR6E 3481	4022	BPR7HS 6422	4223	CR8EB 7784
3007	BCPR6E 1269	3179	DCPR7E 3932	4024	BR7HS 4122	4224	CR9EB 6955
3008	BCPR6E-11 3132	3191	BKR5E 7938	4025	B7HS 5110	5008	APR5FS 3122
3009	BCPR6EY-11 3720	3192	BKR7E-11 1283	4026	BR7HIX 7067	5009	APR5FS 3122
3010	BCPR7ES 3330	3194	BKR5EKB-11 3967	4027	B7S 3710	5010	APR5FS 3122
3018	BP5ES 6511	3195	BKR6EKB-11 3583	4028	BP8ES 2912	5012	AP6FS 2710
3021	BPR5ES 7422	3196	BKUR6EK 2213	4030	B8ES 2411	5013	APR6FS 2922
3025	B5ES 6410	3201	BPR5ES-11 4424	4032	B8EGV 5627	5018	FR5-1 7252
3027	BP5EY 7327	3223	BCPR6EP-N-8 5275	4033	BR8ES 5422	5020	BPR4FS 1127
3027	BP5EY 7327	3226	BKR6EP-13 2550	4034	B8EG 3430	5021	BPR4FS-15 2727
3031	BPR5EY 2828	3235	BCRE527Y 2074	4037	BR8HS 4322	5022	BPR5EFS 2223
3031	BPR5EY 2828	3242	DCPR7EVX 1179	4038	B8HS 5510	5024	BP5FS 3412
3032	BPR5EY-11 3028	3242	DCPR7EIX 6046	4039	B8HVX 2634	5025	BPR5FS 2423
3033	BR5HS 3722	3245	PFR7B 4853	4039	BR8HIX 7001	5026	BPR5FS-11 2924
3034	B5HS 4210	3246	PZFR5F-11 4363	4040	B8S 3810	5027	BPR5FS-15 3124
3035	B6L 3212	3247	PZFR6F-11 3271	4045	BR9ES 5722	5029	BR5FS 4123
3043	BP6ES 7811	3249	BKR7EKC-N 2095	4046	B9ES 2611	5030	BR5FS-15 2224
3045	BPR6EIX 6637	3253	BKR6EKP-11 3452	4047	B9EG 3530	5031	BP6EFS 3812
3047	BPR6ES 7822	3255	BCP7ES 5030	4048	B9EGV 5827	5032	BPR6EFS 3623
3049	BPR6ES-11 4824	3257	BCPR7ES-11 1095	4052	B9HS 5810	5034	BP6FS 3512
3051	B6ES 7310	3264	PFR5B-11 2300	4053	BR9HIX 5687	5035	BPR6FS 2623
3054	BR6ES 4922	3265	PFR7G-11S 7772	4054	BR9HS 4522	5038	BR6FS 4323
3056	BR6ES 4922	3270	PGR5A 3987	4057	B9SEGV 2145	5040	BP7EFS 3526
3062	BP6EY 7727	3273	PFR7B 4853	4063	B10EGV 5927	5062	BKUR7ET 7873
3066	BPR6EY 6427	3275	PFR5G-11 2647	4067	B10HVX 2940	5065	BP6ET 1263
3067	BPR6EY-11 4228	3276	BK6E 3536	4075	DR5HS 4623	5067	BUR6ET 3172
3068	BP6HS 4511	3277	BPR6EKN 1128	4078	D6HA 6512	5068	PTR5A-10 5055
3070	BPR6HS 7022	3293	BKR5EVX 2546	4080	DR6HS 4823	5069	BCP7ET 2078
3073	B6HS 4510	3297	IFR6T11 4589	4086	DPR7EA-9 5129	5070	PTR5D-10 3784
3075	B6S 3510	3302	PGR7A 3200	4090	D7EA 7912	5086	TR5A-10 0005
3076	BR6S 3522	3303	IFR5T-8N 3508	4091	DR7ES 3123	5087	ITR6F13 4477
3081	BR7ET 4121	3304	BKR6EKC 2848	4093	DPR8EA-9 4929	5093	PTR5A-10 5055
3082	BR7ET 4121	3306	PGR6A 4984	4096	DPR8EA-9 4929	5301	BCPR5EIX-11 3306
3085	BP7ES 2412	3307	IFR6D10 5344	4099	D8EA 2120	5302	BCPR6EIX-11 4919
3086	BPR7EIX 4055	3312	DCPR8E 4339	4101	DR8ES-L 2923	5303	BKR5EIX-11 5464
3088	BPR7ES 2023						

DENSO	NGK → STOCK No.	DENSO	NGK → STOCK No.	DENSO	NGK → STOCK No.	DENSO	NGK → STOCK No.
5304	BKR6EIX-11 3764	5749	R7438-8 4905	IK27C11	FR9BI-11 4709	K20P-U	BK6E 3536
5306	BPR6EIX-11 3903	5750	R7438-9 4656	IK31	R7434-10 4894	K20R-U	BKR6EYA 2249
5307	BPR7EIX 4055	5752	R7440B-10T 5009	IKH01-24	R7438-8 4905	K20R-U11	BKR6EYA-11 4073
5308	DCPR7EIX 6046	5753	R7440B-11T 5495	IKH01-27	R7438-9 4656	K20R-ZU11	BKR6EP-11 2978
5309	DCPR8EIX 6546	5754	R7440A-9L 3795	IKH22	ILFR7H 5245	K20TNR	BKR6EKC 2848
5310	BKR7EIX 2667	5755	R7440A-10L 4282	IQ01-24	R7436-8 4898	K20TNR-S	BKUR6EK 2213
5311	BKR8EIX 2668	6000	BUHX 2522	IQ01-27	R7436-9 4899	K20TR-11	BKR6EKB-11 3583
5312	BKR9EIX 2669	6001	BUHW 2622	IQ01-31	R7436-10 4900	K20TRX	BKR6EKU 6993
5316	BR8EIX 5044	6002	BUHW-2 5626	IQ02-24	R7436-8 4898	K20TXR	BKR6EKC 2848
5317	BR9EIX 3981	6004	B2 3110	IQ02-27	R7436-9 4899	K22PB	BCP7ET 2078
5319	BR10EIX 6801	6005	BP2ES 3467	IQ02-31	R7436-10 4900	K22PBR-S	BKUR7ET 7873
5321	R7434-10 4894	6009	B4ES 4129	IQ16	BCPR5EIX-11 3306	K22PR-U	BKR7E 6097
5326	BPR6EFIX-11 94658	6011	BPR4ES 7222	IQ20	BCPR6EIX-11 4919	K22PR-U11	BKR7E-11 1283
5336	FR9BI-11 4709	6013	B4L 3112	IQ22	BCPR7EIX 5690	K22PR-ZU	BKR7EIX 2667
5337	DCPR9EIX 2316	6015	BM4A 5628	IRE01 27	R7420-9 6448	K22TMR	BKR7EKC-N 2095
5338	LTR5IX-11 4344	6018	BPMR4A 6028	IRE01 31	R7420-10 5501	K22TMR11	BKR7EKC-N 2095
5339	PLTR6A-10G 3587	6019	BMR4A 5728	IRE01 34	R7420-11 7756	KJ16CR	ZFR5F 5165
5345	ILFR7H 5245	6021	BP4 2911	IRL01-27	R7440A-9L 3795	KJ16CR-11	ZFR5F-11 2262
5348	BKR7EIX 2667	6023	BPM6A 7021	IRL01-31	R7440A-10L 4282	KJ16CR-L11	ZFR5J-11 5584
5349	LZTR5AIX-13 2314	6025	BMR6A 7421	IRT01-31	R7440B-10T 5009	KJ16CR-U11	ZFR5F-11 2262
5351	BKR5EIX-11 5464	6028	B9HS-10 3626	IRT01-34	R7440B-11T 5495	KJ20CR-11	ZFR6F-11 4291
5352	BKR6EIX-11 3764	6033	B4 3210	IT20	BPR6EFIX-11 94658	KJ20CR-L11	ZFR6J-11 5585
5361	CR7EIX 7385	6034	BM4A 5628	ITL16	LZTR5AIX-13 2314	KJ20CR-U11	ZFR6F-11 4291
5362	CR8EIX 4218	6035	B4LM 3410	ITV16	LTR5IX-11 4344	KJ20DR-M11	ZFR6K-11 6711
5363	CR9EIX 3521	6036	BM6A 5921	IU01-27	R0373A-9 3388	KJ22CR-L11	ZFR7F-11 2975
5368	CR8EHIX-9 3797	6039	BM6F 6221	IU01-31	R0373A-10 4940	L14-U	AB6 2910
5369	CR9EHIX-9 6216	6040	BPM6F 5950	IU01-34	R0373A-11 5566	M17	AB6 2910
5372	DR8EIX 6681	6041	BM7F 6421	IU22	CR7EIX 7385	M22	AB7 3010
5373	DR9EIX 4772	6042	BPM7F 1268	IU24	CR8EIX 4218	M24S	AB8 7909
5375	DPR7EIX-9 7803	6043	BPMR7A 4626	IU27	CR9EIX 3521	MA16PR-U	APR5FS 3122
5376	DPR8EIX-9 2202	6044	BPR2ES 2264	IU27D	CR9EIA-9 6289	MA16PR-U11	APR5FS 3122
5377	DPR9EIX-9 5545	6047	B8HS-10 5126	IU31	CR10EIX 6482	MA16PR-U15	APR5FS 3122
5378	BPR6HIX 4085	6048	BM7A 6521	IUF22	CR7HIX 7544	MA17P-U	AP6FS 2710
5379	BR7HIX 7067	6049	BPM7A 7321	IUF24	CR8HIX 7669	MA20PR-U	APR6FS 2922
5380	BR8HIX 7001	6050	CR5HSB 6535	IUH24	CR8EHIX-9 3797	MA20P-U	AP6FS 2710
5383	CR7HIX 7544	6051	B7HS 5110	IUH27	CR9EHIX-9 6216	P16PR8	PGR5A 3987
5384	CR8HIX 7669	6052	B7HS-10 2129	IUH27D	CR9EHI-9 6419	P16R	BPR5EP-11 3971
5388	CR9EHI-9 6419	6053	BR6HS 3922	IW01-27	R7376-9 7763	P20PR8	PGR6A 4984
5390	CR9EIA-9 6289	6054	B6HS 4510	IW01-31	R7376-10 4457	P22PR8	PGR7A 3200
5502	BPR6EIX-LPG 2347	6057	B2LM 1147	IW06-27	R7376-9 7763	PK16PR11	PFR5B-11 2300
5603	IFR5J11 7418	6060	B8HS 5510	IW06-31	R7376-10 4457	PK16PR-L11	PFR5G-11 2647
5607	BPR7EIX 4055	6068	BR8ES 5422	IW20	BPR6EIX-11 3903	PK16PR-P11	PFR5J-11 4642
5614	IJR7A9 7901	6069	BR9ES 5722	IW22	BPR7EIX 4055	PK16R11	BKR5EP-11 3440
5615	IFR6L11 3678	6070	CR4HSB 4695	IW24	BR8EIX 5044	PK20PR11	PFR6B-11 4014
5616	IFR8H11 5068	6071	BR2LM 5798	IW27	BR9EIX 3981	PK20PR-L11	PFR6G-11 5555
5618	ILFR6J-11K 4458	6073	B8HS-10 5126	IW31	BR10EIX 6801	PK20PR-P11	PFR6J-11 2743
5619	ILFR7H 5245	6076	IFR5A-11 6376	IWF20	BPR6HIX 4085	PK20PR-P8	PFR6B 3500
5628	IFR5L11 6502	6079	CM-6 5812	IWF22	BR7HIX 7067	PK20R11	BKR6EP-11 2978
5630	IFR9H11 6588	90919-01217	IFR5T11 4996	IWF24	BR8HIX 7001	PK20R-13	BKR6EP-13 2550
5631	IMR9B-9H 4888	90919-01218	IFR5T11 4996	IWM-01-32	R6179A-105P 2697	PK20R8	BKR6EP-8 2215
5633	IZFR6F11 4095	90919-01240	IFR5T11 4996	IX22B	DPR7EIX-9 7803	PK20TR11	BKR6EKP-11 3452
5642	IMR9C-9HES 5766	9807B-5615P	ZFR6K-11 6711	IX24	DR8EIX 6681	PK22PR11	PFR7G-11S 7772
5701	R7434-8 4892	9807B-5615W	IZFR6K11 6994	IX24B	DPR8EIX-9 2202	PK22PR8	PFR7B 4853
5702	R7434-9 4658	FXE20HR11	PLZKAR6A-11 5118	IX27	DR9EIX 4772	PK22PR-L11	PFR7G-11S 7772
5703	R7434-10 4894	IA01-32	R7282A-105 4614	IX27B	DPR9EIX-9 5545	PK22PR-L11S	PFR7G-11S 7772
5704	R7434-8 4892	IA01-34	R7282A-11 4754	IXU22	DCPR7EIX 6046	PK22PR-TP	PFR7M 4877
5705	R7434-9 4658	IAE01-32	R7282-105 4985	IXU24	DCPR8EIX 6546	PKJ16CR-L11	PZFR5F-11 4363
5706	R7434-10 4894	IAE01-34	R7282-11 2001	IXU27	DCPR9EIX 2316	PKJ20CR8	PZFR6F 7550
5707	R7436-8 4898	IK01-24	R7434-8 4892	K14P-U11	BKR5E-11 6953	PKJ20CR-L11	PZFR6F-11 3271
5708	R7436-9 4899	IK01-27	R7434-9 4658	K16GPR-U11	ZFR5E-11 4435	PQ16R	BCPR5EP-11 2097
5709	R7436-10 4900	IK01-31	R7434-10 4894	K16HPR-U11	IFR5A-11 6376	PQ16R8	BCPR5EP-8 2950
5710	R7436-8 4898	IK02-24	R7434-8 4892	K16PRP11	BKR5EVX 2546	PQ20R	BCPR6EP-11 3350
5711	R7436-9 4899	IK02-27	R7434-9 4658	K16PR-U	BKR5E 7938	PQ20R8	BCPR6EP-N-8 5275
5712	R7436-10 4900	IK02-31	R7434-10 4894	K16PR-U11	BKR5E-11 6953	PQ20R-P11	BCPR6EP-N-11 4497
5714	R7376-9 7763	IK16	BKR5EIX-11 5464	K16R-U	BKR5EYA 2087	PQ20R-P8	BCPR6EP-N-8 5275
5716	R7376-10 4457	IK16G	BKR5EIX-11 5464	K16R-U11	BKR5EYA-11 2526	PT16EPR10	PTR5D-10 3784
5724	R7282A-105 4614	IK16L	ZFR5F1X-11 2477	K16TNR-S9	BKR5EKC 5216	PT16EPR13	PTR5D-10 3784
5725	R7282A-11 4754	IK20	BKR6EIX-11 3764	K16TR-11	BKR5EKB-11 3967	PT16EPR13	PTR5D-10 3784
5728	R6179A-105P 2697	IK20G	BKR6EIX-11 3764	K20BR-S10	BKUR6ETB-10 5742	PT16VR10	PTR5A-10 5055
5735	R0373A-9 3388	IK20L	ZFR6FIX-11 6441	K20HR-U11	IFR6C-11 5788	PT16VR-13	PTR5A-10 5055
5736	R0373A-10 4940	IK22	BKR7EIX 2667	K20PR-L11	BKR6E-N-11 5724	PTJ16CR15	PZTR5A-15 7862
5737	R0373A-11 5566	IK22G	BKR7EIX 2667	K20PR-U	BKR6E 6962	Q16PR-U	BCPR5E 1145
5747	R7282-105 4985	IK24	BKR8EIX 2668	K20PR-U11	BKR6E-11 2756	Q20PR-U	BCPR6E 1269
5748	R7282-11 2001	IK27	BKR9EIX 2669	K20PSR-B8	IFR6S 99404	Q20PR-U11	BCPR6E-11 3132

DENSO	NGK → STOCK No.	DENSO	NGK → STOCK No.	DENSO	NGK → STOCK No.	DENSO	NGK → STOCK No.				
Q20P-U	BCP6ES	4930	U22FS-L	C7HSA	4629	W16EPR-U11	BPR5ES-11	4424	W22FP-U	BP7HS	5111
Q20R-U11	BCPR6EY-11	3720	U22FSR-L	CR7HS	7223	W16EP-U	BP5ES	6511	W22FP-U10	BP7HS-10	7829
Q22PR-U	BCPR7ES	3330	U22FSR-U	CR7HSA	4549	W16EP-ZU	BPR5EIX-11	6597	W22FS	B7HS	5110
Q22PR-U11	BCPR7ES-11	1095	U22FS-U	C7HSA	4629	W16ES	B5ES	6410	W22FS-GU	BR7HIX	7067
Q22P-U	BCP7ES	5030	U24ES-N	C8E	7471	W16ES-L	BR5ES	4722	W22FSR	BR7HS	4122
Q27A-Z	R7232-9	5516	U24ESR-N	CR8E	1275	W16ESR-U	BR5ES	4722	W22FS-U	B7HS	5110
QJ16AR-U	BCRE527Y	2074	U24ESR-NB	CR8EB	7784	W16ES-U	B5ES	6410	W22FS-U10	B7HS-10	2129
QJ16HR-U	FR5-1	7252	U24ESR-NZU	CR8EIX	4218	W16EXR-U	BPR5EY	2828	W22FS-ZU	BR7HIX	7067
QJ16HR-U9	FR5-1	7252	U24ETR	CR8EK	3478	W16EXR-U11	BPR5EY-11	3028	W22M	BM7A	6521
QJ20CR-11	ZFR6A-11	1041	U24FER9	CR8EH-9	5666	W16EX-U	BP5EY	7327	W22MPR-U	BPMR7A	4626
S22PR-A7	IGR7A	6687	U24FS	C8HSA	6821	W16FP	BP5HS	4111	W22MP-U	BPM7A	7321
SC20HR11	ILKAR7B11	4912	U24FS-C	C8HSA	6821	W16FPR	BPR5HS	6222	W22MP-US	BPM7A	7321
SF-10	BUHX	2522	U24FS-L	C8HSA	6821	W16FPR-U	BPR5HS	6222	W22M-U	BM7A	6521
SF-50	BUHW	2622	U24FSR-C	CR8HSA	2086	W16FP-U	BP5HS	4111	W22M-US	BM7A	6521
SF-51	BUHW-2	5626	U24FSR-U	CR8HS	7423	W16FS	B5HS	4210	W22S	B7S	3710
SK16PR11	IFR5G-11K	3107	U24FS-U	C8HSA	6821	W16FSR	BR5HS	3722	W22S-U	B7S	3710
SK16PR-A11	IFR5E11	7994	U27ES-N	C9E	7499	W16FS-U	B5HS	4210	W24EP	BP8ES	2912
SK16PR-L11	IFR5G-11K	3107	U27ESR-N	CR9E	6263	W16LS	B6L	3212	W24EP-11	BP8ES	2912
SK16R11	IFR5T11	4996	U27ESR-NB	CR9EB	6955	W16P-U	BP5S	3011	W24EP-U	BP8ES	2912
SK16R-P8	IFR5T-8N	3508	U27ESR-NZU	CR9EIX	3521	W17ES	B6ES	7310	W24ES	B8ES	2411
SK20PR-A11	IFR6E11	6741	U27ETR	CR9EK	4548	W20EPB	BP6ET	1263	W24ES-GU	BR8EIX	5044
SK20PR-L11	IFR6G11K	1314	U27FER-9	CR9EH-9	7502	W20EPBRS	BJR6ET	3172	W24ESR	BR8ES	5422
SK20PR-L9	IFR6D10	5344	U27FER-ZU9	CR9EHIX-9	6216	W20EP-GU	BPR6EIX	6637	W24ESR-U	BR8ES	5422
SK20R11	IFR6T11	4589	U31ESR-N	CR10E	6264	W20EPR-U	BPR6ES	7822	W24ESR-ZU	BR8EIX	5044
SK20R-P11	IFR6T11	4589	U31ESR-NZU	CR10EIX	6482	W20EPR-U10	BPR6ES-11	4824	W24ES-U	B8ES	2411
SK22PR-M11	IFR7G-11KS	7746	U31ETR	CR10EK	2360	W20EPR-U11	BPR6ES-11	4824	W24ES-V	B8EG	3430
SK22PR-M11S	IFR7G-11KS	7746	VK16	IFR5J11	7418	W20EPR-ZU	BPR6EIX	6637	W24ES-ZU	B8EGV	5627
SKJ16CR-A8	IZFR5G	5887	VK16PR-Z11	IFR5L11	6502	W20EP-U	BP6ES	7811	W24FPR	BPR8HS	3725
SKJ20DR-M11	IZFR6K11	6994	VK20PR-Z11	IFR6L11	3678	W20EP-ZU	BPR6EIX	6637	W24FP-U	BP8HS	2630
SKJ20DR-M11S	IZFR6K-11S	5266	VK20T	BKR6EIX-LPG	3356	W20ES	B6ES	7310	W24FS	B8HS	5510
SVK20R-Z11	IFR6J11	7658	VK24PR-Z11	IFR8H11	5068	W20ES-L	BR6ES	4922	W24FS-GU	B8HVX	2634
SVK20R-Z8	BKR6EP-8	2215	VK27PR-Z11	IFR9H11	6588	W20ESR	BR6ES	4922	W24FS-GU	BR8HIX	7001
SXU22PR9	IKR7D	4759	VKH20	ILFR6J-11K	4458	W20ESR-L	BR6ES	4922	W24FSR	BR8HS	4322
T14PR-U	BPR4FS	1127	VKH20Y	ILFR6B	6481	W20ESR-U	BR6ES	4922	W24FS-U	B8HS	5510
T14PR-U15	BPR4FS-15	2727	VKH22	ILFR7H	5245	W20ES-U	B6ES	7310	W24FS-U10	B8HS-10	5126
T16EPR-U	BPR5EFS	2223	VKJ20RZ-M11	IZFR6F11	4095	W20ETR-L	BPR6EKN	1128	W24FS-ZU	B8HVX	2634
T16EX-U	BP5EFS	3712	VNH27Z	IMR9B-9H	4888	W20EXR-U	BPR6EY	6427	W24FS-ZU	BR8HIX	7001
T16PR-U	BPR5FS	2423	VUH24D	IMR8C-9H	3653	W20EXR-U11	BPR6EY-11	4228	W24S	B8S	3810
T16PR-U11	BPR5FS-11	2924	VUH27D	IMR9C-9H	6777	W20EX-U	BP6EY	7727	W24S-U	B8S	3810
T16PR-U15	BPR5FS-15	3124	VUH27ES	IMR9C-9HES	5766	W20FP	BP6HS	4511	W25EB	BR8ET	4221
T16P-U	BP5FS	3412	VUH27Z	IMR9A-9H	6966	W20FPR	BPR6HS	7022	W25EBR	BR8ET	4221
T16R-U	BR5FS	4123	VW20T	BPR6EIX-LPG	2347	W20FPR-U	BPR6HS	7022	W25EDR	BR8EQ	3328
T16R-U15	BR5FS-15	2224	VW22	BPR7EIX	4055	W20FP-U	BP6HS	4511	W25EN	B8EG	3430
T16VR-U10	TR5A-10	0005	VX22BC	IJR7A9	7901	W20FP-U10	BP6HS-10	6326	W25EPT	BR8EGP	2046
T20EPR-U	BPR6EFS	3623	VX22BZ	IJR7A9	7901	W20FR-L	BPR6HSA	4632	W25FN	B8HVX	2634
T20EP-U	BP6EFS	3812	W14	B4	3210	W20FS	B6HS	4510	W25FN	BR8HIX	7001
T20EX-U	BP6EFS	3812	W14E	B4ES	4129	W20FSR	BR6HS	3922	W27EBR	BR9ET	4528
T20MP-U	BPM6F	5950	W14EPR-U	BPR4ES	7222	W20FSR-U	BR6HS	3922	W27EMR-C	BR9ECM	3252
T20M-U	BM6F	6221	W14ER-U	BR4ES	1097	W20FS-U	B6HS	4510	W27EN	B9EG	3530
T20PR-U	BPR6FS	2623	W14F	B4H	4110	W20M	BM6A	5921	W27ES	B9ES	2611
T20PR-U15	BPR6FS	2623	W14FP	BP4HS	3611	W20MP-U	BPM6A	7021	W27ES-GU	BR9EIX	3981
T20P-U	BP6FS	3512	W14FP-L	BP4HS	3611	W20MR-U	BMR6A	7421	W27ESR	BR9ES	5722
T20R-U	BR6FS	4323	W14FPR	BPR4HS	7823	W20M-U	BM6A	5921	W27ESR-U	BR9ES	5722
T22EP-U	BP7EFS	3526	W14FPR-L	BPR4HS	7823	W20M-US	BM6A	5921	W27ES-U	B9ES	2611
T22MP-U	BPM7F	1268	W14FPR-UL	BPR4HS	7823	W20S	B6S	3510	W27ES-V	B9EG	3530
T22M-U	BM7F	6421	W14FPR-UL10	BPR4HS-10	5024	W20SR-U	BR6S	3522	W27ES-ZU	B9EGV	5827
TR20	B6HS	4510	W14FP-U	BP4HS	3611	W20S-U	B6S	3510	W27FS	B9HS	5810
TR22	B7HS	5110	W14FP-UL	BP4HS	3611	W22EB	BR7ET	4121	W27FS-GU	BR9HIX	5687
TR22-10	B7HS-10	2129	W14FR-U	BR4HS	3322	W22EBR	BR7ET	4121	W27FSR	BR9HS	4522
TR24	B8HS	5510	W14F-U	B4H	4110	W22EDR	BR7EQ	5128	W27FS-U	B9HS	5810
TR24-10	B8HS-10	5126	W14L	B4L	3112	W22EP	BP7ES	2412	W27FS-U10	B9HS-10	3626
U14FSR-UB	CR4HSB	4695	W14LMR-US	BR4LM	4133	W22EP-GU	BPR7EIX	4055	W27FS-ZU	BR9HIX	5687
U16FER-9	CR5EH-9	6689	W14LM-U	B4LM	3410	W22EPR-U	BPR7ES	2023	W29ES-GU	B95EGV	2145
U16FSR-UB	CR5HSB	6535	W14LM-US	B4LM	3410	W22EP-U	BP7ES	2412	W29ES-ZU	B95EGV	2145
U20EPR-U	CPR6EA-9	6899	W14MMPR-U10	BPMR4A	6028	W22EP-ZU	BPR7EIX	4055	W31EN	B10EG	3630
U20ESR-N	CR6E	6965	W14MR-U	BMR4A	5728	W22ES	B7ES	1111	W31EPT	B10EGP	5224
U20FS	C6HSA	3228	W14M-U	BM4A	5628	W22ES-GU	BR7EIX	6664	W31ES-GU	B10EIX	6801
U20FS-L	C6HSA	3228	W14M-US	BM4A	5628	W22ESR	BR7ES	5122	W31ESR-U	BR10ES	4832
U20FSR-U	CR6HSA	2983	W14P	BP5S	3011	W22ESR-U	BR7ES	5122	W31ES-ZU	B10EGV	5927
U20FS-U	C6HSA	3228	W14PR-U	BP4	2911	W22ES-U	B7ES	1111	W31FS-GU	B10HVX	2940
U20M-U	CM-6	5812	W14-U	B4	3210	W22ES-ZU	BR7EIX	6664	W31FS-ZU	B10HVX	2940
U22ES-N	C7E	5096	W14-US	B4	3210	W22FP	BP7HS	5111	W32EPT	B10EGP	2077
U22ESR-N	CR7E	4578	W16EP-GU	BPR5EIX-11	6597	W22FPR	BPR7HS	6422	W34ES-ZU	B11EGV	5831
U22FS	C7HSA	4629	W16EPR-U	BPR5ES	7422	W22FPR-U	BPR7HS	6422	W9	B2	3110

DENSO	NGK → STOCK No.	ENKER/BOSNA	NGK → STOCK No.	EYQUEM	NGK → STOCK No.	EYQUEM	NGK → STOCK No.				
W9EP	BP2ES	3467	FE65CP	BP6ES	7811	500J	BR6FS	4323	C62LJS	BP6EFS	3812
W9EXR-U	BPR2ES	2264	FE65CPD	BP6ET	1263	500JS	BPR4FS	1127	C62LS	BP6E	7529
W9EX-U	BP2ES	3467	FE70C	B6ES	7310	500M	B5HS	4210	C62LS	BP6ES	7811
W9FP	BP2HS	7926	FE75C	B7ES	1111	502 MOTO	B4H	4110	C62LS3X	BP5ET	2287
W9FP-L	BP2HS	7926	FE80C	B8ES	2411	502CT	B4LM	3410	C62S	BP7HS	5111
W9FP-UL	BP2HS	7926	FE85CP	BP7ES	2412	505JS	BP5FS	3412	C72LJS	BP7EFS	3526
W9LMR-US	BR2LM	5798	FE95CP	BP8ES	2912	50AM	B6L	3212	C72LS	BP7ES	2412
W9LM-US	B2LM	1147	FET65CP	BP5EFS	3712	50M	B5HS	4210	C72LS3X	BP6ET	1263
W9P	BP4	2911	FET75CP	BP6EFS	3812	520CS	BP5S	3011	C82LJS	BP7EFS	3526
W9-U	B2	3110	FS20	B2	3110	550CS	BP5S	3011	C82LS	BP7ES	2412
WA20M	BM6F	6221	FS30	B4	3210	550JS	BPR5FS	2423	C92LS	BP8ES	2912
WA20M-U	BM6F	6221	FS50CP	BP5S	3011	550LS	BP5ES	6511	D1000	D8HA	7112
WA22M	BM7F	6421	FS70	B6S	3510	550S	BP4HS	3611	D1000 MOTO	D8HA	7112
WA22M-U	BM7F	6421	FS75C	B7S	3710	580LS	BP5ES	6511	D1000L	D9EA	2420
X16FSR-U	DR5HS	4623	FS80	B8S	3810	580S	BP4HS	3611	D1050L	D9EA	2420
X20FSR-U	DR6HS	4823	FSC50C	BM6A	5921	600CS	BP5S	3011	D755 MOTO	D6HA	6512
X20FS-U	D6HA	6512	FSC50P	BPM6A	7021	600JS	BPR6FS	2623	D775	D6HA	6512
X22EPR-U9	DPR7EA-9	5129	FSC70P	BPM6A	7021	600L	B6ES	7310	D800L	D7EA	7912
X22ESR-U	DR7ES	3123	FSC75CP	BPM7A	7321	600LS	BP6ES	7811	D800L MOTO	D7EA	7912
X22ES-U	D7EA	7912	FT45CP	BP5FS	3412	600S	BP5HS	4111	D900L	D8EA	2120
X24EPR-U9	DPR8EA-9	4929	FT55CP	BP6FS	3512	700	B6HS	4510	FC52LS	BCP5ES	7496
X24EP-U9	DPR8EA-9	4929	FT85CP	BP7FS	3612	700 MOTO	B6HS	4510	FC52LS	BCP5ES	7496
X24ES-GU	DR8EIX	6681	M30	AB2	3020	700CM	B6S	3510	FC58LS	BCP6ES	4930
X24ESR-U	DR8ES-L	2923	M60	AB6	2910	700CTS	BPM6A	7021	FC62LS	BCP6ES	4930
X24ES-U	D8EA	2120	M75	AB7	3010	705JS	BP7FS	3612	FC62LS2	BCP6ES	4930
X24FSR-U	DR8HS	5123	M80	AB8	7909	705L	B6ES	7310	FC62LS3	BCP6ET	4563
X24FS-U	D8HA	7112	MT55CP	AP6FS	2710	705L MOTO	B6ES	7310	FC62LS3X	BCP6ET	4563
X24GPR-U	DPR8Z	4730	MT65CP	AP7FS	2127	705S	BP6HS	4511	FC72LS	BCP7ES	5030
X27EPR-U9	DPR9EA-9	5329	SFE55CP	BCPR5ES	6130	707LS	BP6ES	7811	FC82LS	BCP7ES	5030
X27ESR-U	DR8ES	5423	SFE65CP	BCPR6ES	2330	70M	B6HS	4510	FC82LS1	BCP7ES	5030
X27ESR-ZU	DR9EIX	4772	SFE65CPD	BCP6ET	4563	750	BP6HS	4511	FC82LS2	BCP7ES	5030
X27ES-U	D9EA	2420	SFE85CP	BCPR7ES	3330	750L	B6ES	7310	K200M	AB6	2910
X27GPR-U	DPR9Z	4830	SFE85CPD	BCP7ET	2078	750LJS	BP6EFS	3812	K300M	AB6	2910
XE20HR-U9	LZKAR7A	6799	T70	C6HSA	3228	750LS	BP6ES	7811	K500M	AB6	2910
XU20EPR-U	DCPR6E	3481	T90	C7HSA	4629	753LJS	BP6EFS	3812	K550JS	AP6FS	2710
XU22EPR-U	DCPR7E	3932	EVINRUDE	NGK → STOCK No.		755	B6HS	4510	K600M	AB6	2910
XU22EPR-ZU	DCPR7EVX	1179	204470091	BR7ES	5122	755 MOTO	B6HS	4510	K750M	AB7	3010
XU22EP-U	DCP7E	2363	278000237	BR7ES	5122	755CJT	BM7F	6421	KC62JS	AP6FS	2710
XU22HDR-9	LKR7B-9	5847	278000608	BR7ES	5122	755CM	B6S	3510	R1000	BR8HS	4322
XU22PR-9	DCPR7EA-9	6651	278000609	BR8ES	5422	755CT	BM7A	6521	R1000L	BR8ES	5422
XU24EPR-U	DCPR8E	4339	MCBR10EG	BR10EG	3830	755L	B6ES	7310	R850	BR7HS	4122
XU27EPR-ZU	DCPR9EVX	6436	MCBR8EG	BR8EG	3130	755L MOTO	B6ES	7310	RC42S	BPR6HS	7022
XU27EPR-ZU	DCPR9EIX	2316	MCBR8HS	BR8HS	4322	755LJS	BP6EFS	3812	RC52LJS	BPR5EFS	2223
Y24FER-C	ER8EH	4011	MCBR9EG	BR9EG	3230	755LS	BP6ES	7811	RC52LZ3EX	BUR5ET	3377
Y27FER	ER9EH	5869	MCBR9ES	BR9ES	5722	755LS MOTO	BP6ES	7811	RC52LZE	ZGR5A	5839
Y27FER-C	ER9EH	5869	EYQUEM	NGK → STOCK No.		755M	B6HS	4510	RC58LZ3EX	BUR6ET	3172
Y31FER-C	ER10EH	2862	1000	B8HS	5510	755S	BP6HS	4511	RC62HJS6	TR5A-10	0005
Z20ES-U	D6EA	7512	1000 MOTO	B8HS	5510	75LM	B6ES	7310	RC62HJSP	PTR5A-10	5055
ZT20EPR11	ITR6F13	4477	1000CM	B7S	3710	75M	B6HS	4510	RC62HJSDP	PTR5A-10	5055
ZXU20PR11	IKR6G11	7980	1000L	B8ES	2411	775SX	BP6HS	4511	RC62LJS	BPR6EFS	3623
DODGE - see CHRYSLER GROUP			1000L MOTO	B8HS	5510	775X	B6HS	4510	RC62LS	BPR6ES	7822
DUCATI	NGK → STOCK No.		1000M	B8HS	5510	800L	B6ES	7310	RC62LS5	BPR6ES-11	4824
6704038A1	MAR10A-J	4706	100M	B8HS	5510	800LJS	BP6EFS	3812	RC62S	BPR7HS	6422
ENKER/BOSNA	NGK → STOCK No.		1100	B9HS	5810	800LS	BP6ES	7811	RC82LS	BPR7ES	2023
F100C	B8HS	5510	1100L	B8ES	2411	802L	B6ES	7310	RFC42LS	BKR5E	7938
F45CP	BP4HS	3611	1100L MOTO	B8ES	2411	803LJS	BP6EFS	3812	RFC42LS2E	BKR5EK	7956
F50C	B5HS	4210	1150L	B9ES	2611	805L	B6ES	7310	RFC50LZ2E	BKR5EK	7956
F55CP	BP5HS	4111	200	B4H	4110	805L MOTO	B6ES	7310	RFC52LS	BCPR5ES	6130
F65CP	BP6HS	4511	202CT	B2LM	1147	805LJS	BP7EFS	3526	RFC52LS3	BKR6EKUB	3584
F75C	B6HS	4510	300AM	B4L	3112	805LJSP	BP7EFVX	3344	RFC52LS5	BKR5E-11	6953
F80C	B7HS	5110	30AM	B4L	3112	805LJSP	BP7EIX	3690	RFC52LZE	ZFR5F	5165
F85CP	BP7HS	5111	400J	BR5FS	4123	805LP	BR7EIX	6664	RFC52LZK	BKR5EZ	7642
FA50	B4L	3112	406	BP6HS	4511	850	B7HS	5110	RFC58LS	BKR6E	6962
FA70	B6L	3212	450JS	BPR4FS-15	2727	850 MOTO	B7HS	5110	RFC58LS2E	BKR6EK	2288
FE100C	B9ES	2611	450L	B5ES	6410	850LS	BP7ES	2412	RFC58LS3	BCPR6ET	2197
FE30C	B4ES	4129	480CS	BP5S	3011	C32	B5HS	4210	RFC58LS5	BKR6E-11	2756
FE45CP	BP5ES	6511	500AM	B6L	3212	C32LS	BP5ES	6511	RFC58LSP	BKR6EZ	4619
FE50C	B5ES	6410	500C	B6S	3510	C32S	BP5HS	4111	RFC58LZ	BKR6EY	3696
FE55CP	BP5ES	6511	500CJT	BM6F	6221	C42LJS3	BP6EFS	3812	RFC58LZ2	BKR6EKC	2848
FE55CPD	BP5ET	2287	500CM	B6S	3510	C42S	BP6HS	4511	RFC58LZ3EX	BKUR6ET	6437
			500CS	BP5S	3011	C52LS	BP5ES	6511	RFC58LZDP	PFR6B	3500
			500CT	BM6A	5921	C62	B7HS	5110	RFC58LZE5	ZFR6F-11	4291
						C62LJS	BP6EF	4666	RFC58LZK	BKR6EZ	4619
									RFC58LZP	PFR6B	3500

EYQUEM	NGK → STOCK No.	FORD	NGK → STOCK No.	FUJI	NGK → STOCK No.	HONDA	NGK → STOCK No.
RFC62LS3X	BCPR6ET 2197	1032705	BKR5EKUP 2890	065-01404-30	BPM6A 7021	98056-57918	CR7HSA-9 5147
RFC62LS5	BCPR6ES-11 7121	1077002	PTR5A-10 5055	065-01404-60	BM6A 5921	98056-58713	C8HSA 6821
RFC62LZ3X	BKUR7ET 7873	1088847	TR5A-10 0005	065-01404-70	BMR6A 7421	98056-58716	CR8HS 7423
RFC82LS	BCPR7ES 3330	1202935	PLTR6A-10G 3587	065-01405-00	B9HS 5810	98056-58718	CR8HSA 2086
RFC82LS3	BCPR7ET 2164	1204572	PTR6F-13 7569	065-01405-10	BR6HS 3922	98059-55916	CR5EH-9 6689
RFC82LS5	BCPR7ES-11 1095	1219309	TR5B-13 4559	932-05410-00	B5ES 6410	98059-57916	CR7EH-9 3486
RFN52HZ	LF5B 7113	1120170	PZFR5D-11 7968	982-05486-00	B6ES 7310	98056-57918	CR7HSA 4549
RFN52LZ	BKR5EZ 7642	1120820	APR6FS 2922			98059-58916	CR8EH-9 5666
RFN58HZ	LF6B 6677	1120830	BCPR6ES 6130			98059-59916	CR9EH-9 7502
RFN58LZ	BKR6EZ 4619	1120831	BCPR6ES 6130	GUTBROD	NGK → STOCK No.	98059-5991U	IMR9A-9H 6966
RWC52HSK	LZKAR7A 6799	1120836	BPR6ES 7822	000.81.345	B4LM 3410	98059-599U	CR9EH-9 6419
T850	C7HSA 4629	1233897	PTR5A-10 5055	090.33.668	B4H 4110	98061-58616	DPR8Z 4730
XKC62JS	APR6FS 2922	1255464	TR5B-13 4559	090.50.805	BPR6ES 7822	98061-59616	DPR9Z 4830
		1307093	PTR6F-13 7569	092.05.406	BR2LM 5798	98066-54716	DR4HS 3326
		1315691	ITR6F13 4477	092.05.900	B6S 3510	98066-55716	DR5HS 4623
FIAT	NGK → STOCK No.	1369704	TR6AF-13 5809	092.13.609	BR4LM 4133	98066-56716	DR6HS 4823
46144731	DCPR8E 4179	1505812	ILFR6B 6481	092.25.081	BP5ES 6511	98066-56717	D6HA 6512
46229251	BP6ES 7811	1M50 12405 CA	PLTR6A-10G 3587	092.32.278	BCPR5ES 6130	98066-58716	DR8HS 5123
46417010	BKR6E 6962	1S7J 12405 DA	PTR6F-13 7569	092.38.072	BPR5ES 7422	98066-58717	D8HA 7112
46449690	BKR6EKPA 2513	1S7J 12405 EB	PTR6F-13 7569	092.38.467	BM6A 5921	98069-38716	DR8ES-L 2923
46463801	BKR6EK 2848	2W93 12405 CAB	IFR5N10 7866	092.40.182	BPR5EFS 2223	98069-55916	DPR5EA-9 2887
46472021	BKR6EK 2848	3SJ4 12405 AB	ITR6F13 4477			98069-56717	D6EA 7512
46475164	BCPR7ET 2164	5M5G 12405 AA	TR6AP-13 5809	HARLEY-DAVIDSON	NGK → STOCK No.	98069-56916	DPR6EA-9 5531
46521529	BKR6EKPA 2513	6M8G 12405 BB	ILTR5A-13G 3811	10R12A	DCPR9E 2641	98069-57716	DR7ES 3123
46521530	PMR7A 4259	95VW 12405 DA	BKR5EKUP 2890	3	B6L 3212	98069-57717	D7EA 7912
46531917	DCPR8EK 7168	AGFS22FE13J	PTR6F-13 7569	3-4	BP5S 3011	98069-5771P	DR7EA 7839
55188857	DCPR7E-N-10 4983	AGPR32PD	BKR5EKUP 2890	4	B6L 3212	98069-57911	DPR7EA-9 5129
55190788	ZKR7A-10 1691	AGPS44F13J	PZFR5D-11 7968	4-5	BP7HS 5111	98069-57912	DPR7EIX-9 7803
55198201	DCPR7E-N-10 4983	AYFS22FE1J	PLTR6A-10G 3587	4R	B6L 3212	98069-57912	DPR7EIX-9 7803
55210685	IKR9F8 5756	AYFS32CJ	TR5B-13 4559	4R5	BPR7HS-10 1092	98069-57916	DPR7EA-9 5129
55233997	LKR9CI-8 94786	AYFS32BB	ILTR5A-13G 3811	5	B6S 3510	98069-5791U	IJR7A9 7901
5894585	BPR7ES 2023	C2A1535	IFR5N10 7866	5A6	BP5ES 6511	98069-58716	DR8ES 5423
5894586	BKR6E 6962	YM21 12405 AA	PZFR5D-11 7968	5R6	BPR5ES 7422	98069-58717	D8EA 2120
5894588	BCPR7ES 3330	YN2F 12405 A2A	TR5B-13 4559	5R6A	BPR5ES-11 4424	98069-58912	DPR8EIX-9 2202
5896824	BKR6EK 2848	YN2J 12405 AA	TR5B-13 4559	5RL	ZGR5C 6334	98069-58916	DPR8EA-9 4929
5984036	BPR6ES 7822			6R12	DCPR7E 3932	98069-59717	D9EA 2420
60504563	BP6ES 7811			8	B10EGV 5927	98069-59912	DPR9EIX-9 5545
60512848	BCP6ET 4563	FOMOCO - see FORD				98069-59916	DPR9EA-9 5329
60512929	B7ES 1111			HONDA	NGK → STOCK No.	98069-5991F	DPR9EIX-9 5545
60569957	PFR6B 3500	FUJI	NGK → STOCK No.	12290-PNE-0030	ZFR6K-11 6711	98073-52710	B2 3110
60597490	BCP7ES 5030	065-01400-10	B4 3210	12290-PRB-A01	IFR7G-11KS 7746	98073-54710	B4 3210
60800325	BPR7ES 2023	065-01400-20	B4H 4110	12290-RMX-003	ILFR6J-11K 4458	98073-54740	BM4A 5628
60806024	BP6ET 1263	065-01400-31	B6HS 4510	12290-RMX-013	ILFR6J-11K 4458	98073-54744	BMR4A 5728
60810689	PFR6B 3500	065-01400-41	B7HS 5110	12290-RSH-003	ILFR6G11K 1314	98073-54776	BPMR4A 6028
71711638	BKR6E 6962	065-01400-50	B7ES 1111	31909-MEN-A310-M1	SILMAR9A9S 6213	98073-54944	BPMR4A-10 6328
71711639	BPR6ES 7822	065-01400-60	B6HS 4510	31911-KRN-731	R0409B-8 7791	98073-56740	BM6A 5921
71711640	BPR6ES 7822	065-01400-80	B4 3210	31912-KRN-731	R0409B-9 7792	98073-56741	BPM6A 7021
71711806	BPR6ES 7822	065-01400-90	B7HS 5110	31911-MBW-E11	IMR8C-9H 3653	98073-56744	BMR6A 7421
71711808	BKR6E 6962	065-01401-00	B6ES 7310	31912-MBW-E110	IMR9C-9H 6777	98073-56944	BPMR6A-10 1029
7546519	BKR6E 6962	065-01401-10	B4H 4110	31912-MCW-0030	IMR9B-9H 4888	98076-52711	BP2HS 7926
7544436	BPR7ES 2023	065-01401-30	B7ES 1111	31916-MEH-003	SIMR8A9 91064	98076-54710	B4H 4110
7554442	BP6ES 7811	065-01401-40	B8ES 2411	31912-MEL-003	IMR9C-9HES 5766	98076-54711	BP4HS 3611
7554444	BPR6ES 7822	065-01401-50	BR6HS 3922	31912-MGH-641	IMR8E-9HES 95397	98076-54716	BR4HS 3322
7554445	BP6HS 4511	065-01401-60	B9ES 2611	31915-ZOH-003	CMR5H 5799	98076-54717	BPR4HS 7823
7565476	BR8ES 5422	065-01401-70	BP4HS 3611	31916-KRM-841	CPR8EA-9 2306	98076-54746	BR4HS 3322
7686643	BP6ET 1263	065-01401-80	BR7HS 4122	31916-KWB-601	CPR6EA-9S 1582	98076-54747	BPR4HS 7823
7760381	BPR7ES 2023	065-01401-90	BP4HS 3611	31916-MEH-003	SIMR8A9 81064	98076-54914	BPR4HS-10 5024
7760382	BPR6ES 7822	065-01402-10	BP6HS 4511	31916-ZOH-003	CMR6H 3365	98076-54944	BPR4HS-10 5024
7760383	BKR6E 6962	065-01402-20	BR10EIX 6801	31918-MEB-671	IFR8H11 5068	98076-55711	BP5HS 4111
7760384	BCPR7ES 3330	065-01402-30	BP5ES 6511	31922-MGH-642	IMR8E-9HES 95397	98076-55716	BR5HS 3722
7769243	BCPR6ET 2197	065-01402-40	BR8ES 5422	31988-GEV-761	ER8EH-N 5606	98076-55717	BPR5HS 6222
7772453	BKR6E 6962	065-01402-50	BR9ES 5722	94701-00408	CR9EIA-9 6289	98076-55719	BP5HS 4111
7772515	BPR7ES 2023	065-01402-60	BP5HS 4111	98049-58716	ER8EH 4011	98076-55747	BPR5HS 6222
7910247204	BPR6EFS 3623	065-01402-70	BPR4HS 7823	98049-59716	ER9EH 5869	98076-56711	B6HS 4510
7FYSR	BPR7ES 2023	065-01402-80	BPR5ES 7422	98049-60716	ER10EH 2862	98076-56715	BPR6HSA 4632
7FYSSR	BPR7ES 2023	065-01403-00	BP6ES 7811	98052-56471	CM-6 5812	98076-56716	BR6HS 3922
7GBYSR4	BCPR7ET 2164	065-01403-10	BR4HS 3322	98056-17U	IFR6L11 3678	98076-56717	BPR6HS 7022
7GYSSR	BCPR7ES 3330	065-01403-20	BPR4HS-10 5024	98056-55777	CR5HSB 6535	98076-56719	BP6HS 4511
9614738680	BKR6EK 2848	065-01403-30	BPR4ES 7222	98056-56713	C6HSA 3228	98076-5671G	BR6HSA 4296
9618494580	BKR5EK 7956	065-01403-40	BP2HS 7926	98056-56716	CR6HS 7023	98076-56741	B6HS 4510
9618571880	BKR6EK 2848	065-01403-60	BP2HS 7926	98056-56718	CR6HSA 2983	98076-56747	BPR6HS 7022
9619624580	BKR5EK 7956	065-01403-70	BM4A 5628	98056-57713	C7HSA 4629	98076-56917	BPR6HS-10 2623
9FYSSR	BPR6ES 7822	065-01403-80	BMR4A 5728	98056-57716	CR7HS 7223	98076-57710	B7HS 5110
9GYSSR	BKR6E 6962	065-01403-90	BP4HS 3611	98056-57718	CR7HSA 4549	98076-57711	BP7HS 5111
FPT55210685	IKR9F8 5756	065-01404-20	BPR6HS 7022				

HONDA	NGK → STOCK No.	HONDA	NGK → STOCK No.	ISKRA	NGK → STOCK No.	ISOLATOR	NGK → STOCK No.					
98076-57716	BR7HS	4122	98079-57847	BR7ES	5122	FE155P	BPR8EIX	6684	FM14-225/2	BP7ES	2412	
98076-57717	BPR7HS	6422	98079-57876	BR7ES	5122	FE45P	BP5E	4669	M14-145	B5HS	4210	
98076-57740	B7HS	5110	98079-57877	BR7ES	5122	FE50	B5ES	6410	M14-175	B6HS	4510	
98076-58710	B8HS	5510	98079-57946	BPR7EIX	4055	FE55LRS	ZGR5A	5839	M14-175/2	B6ES	7310	
98076-58711	BP8HS	2630	98079-58644	BR8EIX	5044	FE55LTXS	BUR5ET	3377	M14-225	B7HS	5110	
98076-58716	BR8HS	4322	98079-58646	BR8EIX	5044	FE55LXS	ZGR5A	5839	M14-240	B8HS	5510	
98076-58717	BPR8HS	3725	98079-58648	B8EG	3430	FE55PRS	BPR5ES	7422	M14-260	B9HS	5810	
98076-5871G	BR8HSA	5539	98079-58649	BR8EG	3130	FE55PS	BP5ES	6511	M14-95	B4H	4110	
98076-58740	B8HS	5510	98079-58678	B8EG	3430	FE55PTS	BP5ET	2287	M18-225	AB7	3010	
98076-58747	BPR8HS	3725	98079-58679	BR8EG	3130	FE65LTXS	BUR6ET	3172	M18-240	AB7	3010	
98076-59710	B9HS	5810	98079-58810	B8ES	2411	FE65PP2	BPR6EIX	6637	PM14-225	BP7HS	5111	
98076-59716	BR9HS	4522	98079-58816	BR8ES	5422	FE65PRP2	BPR6ES	7822	U7D	BCP6ES	4930	
98079-5414G	ZFR4F-11	4043	98079-58819	BR8ECS	3972	FE65PRS	BPR6ES	7822	U8D	BCP5ES	7496	
98079-54817	BPR4ES	7222	98079-58840	B8ES	2411	FE65PS	BP6ES	7811	ZM14-260	B8HS	5510	
98079-54846	BPR4ES	7222	98079-58842	B8ECS	2821	FE65PTS	BP6ET	1263				
98079-55145	BPR5ES-11	4424	98079-58845	BR8ECM	3035	FE75RS	BR7ES	5122				
98079-55146	BPR5EY-11	3028	98079-58846	BR8ES	5422	FE75S	B7ES	1111	ISUZU	NGK → STOCK No.		
98079-55147	BCPR5ES-11	3524	98079-58847	BPR8ES	3923	FE80RS	BR8ES	5422	5-81380001-0	BPR5ES	7422	
98079-55148	BCPR5E-11	1273	98079-58870	B8ES	2411	FE80S	B8ES	2411	5-81380003-0	BPR5EIX-11	6597	
98079-5514E	BKR5E-11	6953	98079-58876	BR8ES	5422	FE85PRS	BPR7ES	2023	5-81380004-0	BPR6EIX	6637	
98079-5514H	PFR5G-11	2647	98079-59644	BR9EIX	3981	FE85PS	BP7ES	2412	5-81380012-0	BP5EY	7327	
98079-5514P	ZFR5J-11	5584	98079-59646	BR9EIX	3981	FET55PRS	BPR5EFS	2223	5-81380013-0	BP6EY	7727	
98079-5515G	ZFR6F-11	4291	98079-59648	B9EG	3530	FET55PS	BP5EFS	3712	8-94120560-0	BPR5ES-11	4424	
98079-5515U	IFR5L11	6502	98079-59649	BR9EG	3230	FET65PRS	BPR6EFS	3623	8-94217232-0	BPR6ES-11	4824	
98079-5517U	FR6BI-11	4709	98079-59678	B9EG	3530	FET65PS	BP6EFS	3812	8-94219943-0	BPR6ES	7822	
98079-5517V	IFR5G-11K	3107	98079-59679	BR9EG	3230	FET75PS	BP7EFS	3526	8-94328373-0	BKR7E-11	1283	
98079-55810	B5ES	6410	98079-59810	B9ES	2611	FS50KR	BR2LM	5798	8-97012928-0	BKR6E	6962	
98079-55811	BP5ES	6511	98079-59811	B9ES	2611	FS70	B6S	3510	9-82513103-0	BP6ES	7811	
98079-55816	BR5ES	4722	98079-59816	BR9ES	5722	FS70C	BPM6A	7021	9-82513105-0	B6ES	7310	
98079-55817	BPR5ES	7422	98079-59819	BR9ECS	3570	FS75	B7S	3710	9-82513106-0	BP5ES	6511	
98079-55840	B5ES	6410	98079-59842	B9ECS	7058	FS75C	BPM7A	7321	9-82513107-0	B5ES	6410	
98079-55841	BP5ES	6511	98079-59845	BR9ECM	3252	FT65PS	BP6FS	3512	9-82513113-0	B7ES	1111	
98079-55844	BPR5EIX-11	6597	98079-59847	BR9ES	5722	FUT55PRP-13	PTR5A-10	5055				
98079-55846	BPR5ES	7422	98079-59870	B9ES	2611	M60	AB6	2910	ITALJET	NGK → STOCK No.		
98079-55847	BR5ES	4722	98079-59876	BR9ES	5722	M75	AB7	3010	94004	BR7HS	4122	
98079-55941	BP5EY	7327	98079-60616	BR10EIX	6801	M80	AB8	7909	94015	DR8EA	7162	
98079-55946	BPR5EY	2828	98079-60646	BR10EIX	6801	MT65PRS	APR6FS	2922	94025	BR8HS	4322	
98079-56145	BPR6ES-11	4824	98079-60648	B10EG	3630	MT65PS	AP6FS	2710	94029	BR9ES	5722	
98079-56146	BPR6EY-11	4228	98079-60649	BR10EG	3830	SFE55LRS	ZFR5F	5165	94032	CR7E	4578	
98079-56147	BCPR6ES-11	7121	98079-60676	BR10EIX	6801	SFE55LXS	ZFR5F	5165				
98079-56148	BCPR6E-11	3132	98079-60678	B10EG	3630	SFE55PRS	BCPR5ES	6130	JAGUAR	NGK → STOCK No.		
98079-56149	BCPR6EY-11	3720	98079-60679	BR10EG	3830	SFE55PRS	BKR5E	7938	2W93	12405	CAIFR5N10	7866
98079-5614E	BKR6E-11	2756	98079-60817	BR10ES	4832	SFE55PS	BCP5ES	7496	96JV12405	EAA	PFR5G-11E	3000
98079-5614G	ZFR6F-11	4291	98079-60819	BR10ECS	5880	SFE65LDRS	BKR5EK	7956	96JV12405	FAA	BKR5EVXA-13	1188
98079-5614H	PFR6G-11	5555	98079-60845	BR10ECM	4234	SFE65LRS	ZFR6A-11	1041	96JV12405	HAA	PFR5G-13E	2761
98079-5614J	BKR6E-N-11	5724	9807B-561BW	IZFR6K-11S	5266	SFE65LTXS	BKUR6ET	6437	96JV12405	HBA	PFR6G-13E	2341
98079-5614N	PZFR6F-11	3271	9807B-5615W	IZFR6K11	6994	SFE65LXS	ZFR6A-11	1041	AB3850DA	BR6EF		3177
98079-5614P	ZFR6J-11	5585	9807B-5617W	IZFR6K11	6994	SFE65PDRS	BKR6EKC	2848	AJ812146	ILKAR6C10		95843
98079-5615G	ZFR6F-11	4291	98179-56841	BP6ES	7811	SFE65PRS	BKR6E	6962	AJ84575	IFR5N10		7866
98079-5615N	PZFR6F-11	3271				SFE65PRS	BKR6ES	3783	C2A1535	IFR5N10		7866
98079-5617U	IFR6L11	3678	HYUNDAI	NGK → STOCK No.		SFE65PS	BCP6ES	4930	C2S46895	TR6AP-13E		4968
98079-56810	B6ES	7310	18 827 090 80	LKR6D-10E	96569	SFE65PTRS	BCPR6ET	2197	CA 3850 DA2	BKR6EVXA-11		6838
98079-56811	BP6ES	7811	18 854 100 80	LZKR6B-10E	1578	SFE65PTS	BCP6ET	4563	CA 3850 FA1	BKR5EVXA-13		1188
98079-56817	BR6ES	4922	18 855 100 60	LZKR6B-10E	1578	SFE85LDRS	BKR6EK	2288	CA 3850 HA2	PFR6G-13E		2341
98079-56840	B6ES	7310				SFE85LTRS	BKUR7ET	7873	EAC8344	B8ES		2411
98079-56841	BP6ES	7811	ISKRA	NGK → STOCK No.		SFE85PR5	BKR7E	6097	EAC8554	BR7EFS		1094
98079-56844	BPR6EIX	6637	F100RS	BR8HS	4322	SFE85PRS	BCPR7ES	3330	EBC4021	BR7EF		3346
98079-56846	BPR6ES	7822	F100S	B8HS	5510	SFE85PS	BCP7ES	5030	EBC8523	B7ES		1111
98079-56847	BR6ES	4922	F20	B4H	4110	SFE85PTRS	BCPR7ET	2164	JC2S	46895	TR6AP-13E	4968
98079-56941	BP6EY	7727	F50	B5HS	4210	SFE85PTS	BCP7ET	2078	NCA 3850 DA2	BKR6EVXA-11		6838
98079-56946	BPR6EY	6427	F55PS	BP5HS	4111	T90	C7HSA	4629	NCA 3850 FA1	BKR5EVXA-13		1188
98079-57145	BPR7ES-11	7226	F65PRS	BPR6HS	7022	TWE85PRS	DCPR8E	4179	NCA 3850 HA2	PFR6G-13E		2341
98079-5714E	BKR7E-11	1283	F65PS	BP6HS	4511	TWE85PS	DCP7E	2363	XR819660	TR6AP-13E		4968
98079-5714G	ZFR7F-11	2975	F70	B5HS	4210				XR842795	TR6AP-13E		4968
98079-5714H	PFR7G-11S	7772	F75RS	BR6HS	3922	ISOLATOR	NGK → STOCK No.					
98079-5715H	PFR7G-11S	7772	F75S	B6HS	4510	6B	BP6HS	4511	JAPCAR	NGK → STOCK No.		
98079-571BV	IFR7G-11KS	7746	F80RS	BR7HS	4122	7A	B6HS	4510	123762	BP5ES		6511
98079-57614	BR7EIX	6664	F80S	B7HS	5110	7B	BP6HS	4511	123770	BP6ES		7811
98079-57810	B7ES	1111	F85PS	BP7HS	5111	7D	BP6ES	7811	123778	BPR5ES		7422
98079-57811	BP7ES	2412	F95PS	BP7HS	5111	A5D	BP7EFS	3526	123789	BPR6ES		7822
98079-57816	BR7ES	5122	FE100RS	BR9ES	5722	A7D	BP6EFS	3812	123801	BPR7ES		2023
98079-57840	B7ES	1111	FE100S	B9ES	2611	FM14-145/2	BP5ES	6511	123825	BPR5ES-11		4424
98079-57841	BP7ES	2412	FE145P	BP9ES	7526	FM14-175/2	BP6ES	7811	123834	BPR6ES-11		4824
98079-57846	BPR7ES	2023	FE155P	BP8EVX	2671	FM14-200/2	BP6ES	7811	123887	BPR5ES		7422
									123899	BPR6ES		7822

JAPCAR	NGK → STOCK No.	
123908	BPR7ES	2023
123932	BPR5ES-11	4424
123940	BPR6ES-11	4824
123993	BPR7ES-11	7226
123996	BR7ES	5122
124040	BPR7ES-11	7226
124144	BPR6ES-11	4824
166573	BPR6ES	7822
167605	PFR6J-11	2743
170006	BPR6ES-11	4824
172988	BPR5ES	7422
173939	BKR6E-11	2756
177391	BKR6E-11	2756
207417	PFR6J-11	2743
239214	PFR5J-11	4642
277200	BKR5E-11	6953
277201	BKR5E-11	6953
279427	PFR5J-11	4045

JEEP - see CHRYSLER GROUP

JENN FENG	NGK → STOCK No.	
9111-310002	BPMR6F	1270
9295-320001	BMR6F	2144
9295-310002	BPMR6F	1270
9295-310502	CMR7H	3066
9295-331501	BPMR7A	4626

JG - see CHINESE BRANDS

JIGUANG - see CHINESE BRANDS

JOHNSON	NGK → STOCK No.	
204470091	BR7ES	5122
278000237	BR7ES	5122
278000608	BR7ES	5122
278000609	BR8ES	5422
MCBR10EG	BR10EG	3830
MCBR8EG	BR8EG	3130
MCBR8HS	BR8HS	4322
MCBR9EG	BR9EG	3230
MCBR9ES	BR9ES	5722

K & N	NGK → STOCK No.	
XP422	PFR6G-11	5555

KAWASAKI	NGK → STOCK No.	
(E)92070-1063	BR9EG	3230
(E)92070-1064	BR8EG	3130
(E)92070-1165	DR7EA	7839
(E)92070-1173	BR10ES	4832
(E)92070-2077	BPR5ES	7422
92070-0010	R6918B-9	2954
92070-0016	BR9ECMVX	2434
92070-1142	C9E	7499
92070-1146	D6EA	7512
92070-1241	R6252K-105	2741
92070-1264	CR9EK	4548
92070-1265	CR8EK	3478
92070-1266	CR9E	6263
92070-2052	BP4HS	3611
92070-2061	BPR4HS	7823
92070-2070	BR4HS	3322
92070-2108	BPMR6A	6726
92070-2110	BPR2ES	2264
92070-3707	PMR9B	4717
92070-7004	BPR4ES	7222
E92070-0001	B7HS	5110
E92070-014	B6ES	7310
E92070-036	B9HS	5810
E92070-037	B8ES	2411
E92070-054	B9ES	2611
E92070-1002	B7ES	1111
E92070-1014	BP8ES	2912

KAWASAKI	NGK → STOCK No.	
E92070-1019	DR8ES	5423
E92070-1022	BR8ES	5422
E92070-1024	BP6ES	7811
E92070-1025	BPR6ES	7822
E92070-1026	BP7ES	2412
E92070-1027	BPR7ES	2023
E92070-1034	D9EA	2420
E92070-1044	BPR8ES	3923
E92070-1053	BR9ES	5722
E92070-1057	B8EG	3430
E92070-1058	B9EG	3530
E92070-1065	DPR8EA-9	4929
E92070-1068	DPR9EA-9	5329
E92070-1109	BR9ES	5722
E92070-1113	DR7ES	3123
E92070-1114	C6HSA	3228
E92070-1116	DR8ES-L	2923
E92070-1125	DPR7EA-9	5129
E92070-1132	B10EG	3630
E92070-1133	BR10EG	3830
E92070-1138	DPR6EA-9	5531
E92070-1143	CR9E	6263
E92070-1145	CR9EK	4548
E92070-1154	CR7HSA	4549
E92070-1155	CR8HSA	2086
E92070-1158	CR8EK	3478
E92070-1169	CR8E	1275
E92070-1173	BR10ES	4832
E92070-1178	BP5ES	6511
E92070-1186	BR10EIX	6801
E92070-1189	DR9EA	3437
E92070-1199	DR8EA	7162
E92070-1209	CR7E	4578
E92070-1212	BR9EIX	3981
E92070-1250	DPR5EA-9	2887
E92070-1254	CR9EKPA	7785
E92070-2072	BMR4A	5728
E92070-2100	BMR2A	7677

KIA	NGK → STOCK No.	
18854-10080	LZKR6B-10E	1578
18855-10060	LZKR6B-10E	1578
OK55818110	PFR6N-11	3546

KLK	NGK → STOCK No.	
F100	B8HS	5510
F20	B4H	4110
F220	B9HS	5810
F50	B5HS	4210
F55P	BP5HS	4111
F65P	BP6HS	4511
F70	B5HS	4210
F75	B6HS	4510
F80	B7HS	5110
F85P	BP6HS	4511
F95P	BP7HS	5111
FA50	B4L	3112
FA70	B6L	3212
FE100	B8ES	2411
FE125P	BP6ES	7811
FE135P	BP7ES	2412
FE145P	BP8ES	2912
FE155P	BP8ES	2912
FE220	B9ES	2611
FE30	B4ES	4129
FE45P	BP5ES	6511
FE50	B5ES	6410
FE55P	BP5ES	6511
FE65P	BP6ES	7811
FE70	B5ES	6410
FE75	B6ES	7310
FE80	B7ES	1111
FE85P	BP6ES	7811
FE95P	BP7ES	2412

KLK	NGK → STOCK No.	
FS100	B8S	3810
FS20	B2	3110
FS30	B4	3210
FS35P	BP4	2911
FS45P	BP5S	3011
FS50	B6S	3510
FS70	B6S	3510
FS75	B7S	3710
FS75H	B7S	3710
FT55P	BP5FS	3412
FT65P	BP5FS	3412
FT85P	BP6FS	3512
FT95P	BP7FS	3612
GT4S	BP5S	3011
GT5	BP5HS	4111
GT5L	BP5ES	6511
GT6	BP6HS	4511
GT6L	BP6ES	7811
GT6T	AP6FS	2710
GT7	BP7HS	5111
GT7L	BP7ES	2412
GT8L	BP8ES	2912
M30	AB2	3020
M50	AB6	2910
M60	AB6	2910
M75	AB7	3010
M80	AB8	7909
MT75P	AP6FS	2710
MT85P	AP6FS	2710
T30	C6HSA	3228
T70	C7HSA	4629
T90	C8HSA	6821
TENL100	C8HSA	6821
TENL30	C7HSA	4629
TFS20	B2	3110
TFS30	B4	3210
TFS50	B6S	3510
TW100	D6HA	6512
TW220	D6HA	6512
TW240	D8HA	7112
TW270	D6HA	6512
TW275	D6HA	6512
TW280	D8HA	7112
TWE270	D8EA	2120
TWE275	D9EA	2420

KTM	NGK → STOCK No.	
452390-93000	LR8B	6208
590390-93100	DCPR8E	4179
515390-93000	BR9ECMVX	2434
610390-93000	DCPR8E	4339
611390-93000	KR8DI	4742
612390-93200	LKAR9BI9	6205
750390-93000	LKAR8AI-9	6706
780390-93000	LKAR8A-9	4786

KUBOTA	NGK → STOCK No.	
07909-2225-0	BM6A	5921
07909-2226-0	BM7A	6521
10202-6771-6	AB6	2910
10261-6771-6	G2Z	3320
12268-6771-1	BP2ES	3467
12366-6771-6	BR4HS	3322
12392-6771-1	BP5ES	6511
12647-6771-1	BPR6HS	7022
12681-6774-1	BR5ES	4722
12691-6771-1	BCP4ES-11	1086
12863-6771-1	BP5ES	6511
12866-6771-1	BP5ES	6511
12992-6771-1	BPR5ES	7422
13078-6771-6	BP6ES	7811
13157-6771-2	BM4A	5628
13211-6771-6	B4	3210
13281-6771-6	B4H	4110

KUBOTA	NGK → STOCK No.	
13301-6771-6	AB2	3020
13373-6774-1	BMR4A	5728
13374-6774-1	BPR4HS	7823
13375-67740	BP5ES	6511
13375-6774-1	BPR4HS-10	5024
13401-6771-6	B6S	3510
13412-6771-6	B7S	3710
13451-6771-6	B6HS	4510
13581-6771-6	B7HS	5110
13582-6771-1	B6HS	4510
13641-6771-1	B4H	4110
13901-6771-6	BP6HS	4511
13979-6771-1	BP4HS	3611

LAND ROVER	NGK → STOCK No.	
LR005253	IFR5N10	7866
LR005483	ILFR6B	6481
LR019484	ILKAR6C10	95843

LD - see CHINESE BRANDS

LEXUS - see TOYOTA

LG - see CHINESE BRANDS

LIXIN - see CHINESE BRANDS

LODGE	NGK → STOCK No.	
15HLNY	BP6ES	7811
25HLD	BCP6ET	4563
25HLNY	BP7ES	2412
25XL	BP6ES	7811
2H	B7HS	5110
2H12	D8HA	7112
2HA	B6S	3510
2HL	B7ES	1111
2HL10	C7HSA	4629
2HLD	BCP6ES	4930
2HL-E	B7ES	1111
2HLN	B7ES	1111
2HLNY	BP7ES	2412
2HN	B7HS	5110
2HNY	BP7HS	5111
2H-TNY	AP7FS	2127
2HTY	BP6FS	3512
2HV	AB8	7909
2XL	BP6ES	7811
3HAN	B8S	3810
3HLN	B8ES	2411
3HLNY	BP7ES	2412
3HN	B8HS	5510
3HNY	BP8ES	2912
4HLNY	BP8ES	2912
5HLNY	BP8ES	2912
B14	B4H	4110
BAN	B4	3210
BANY	BP5S	3011
BBANY	BP4	2911
BBL	AB6	2910
BBNY	BP4HS	3611
BLN	B4ES	4129
BLNY	BP5ES	6511
BLTY	BPR5EFS	2223
BN	B4H	4110
B-TY	BP5FS	3412
BV	AB2	3020
CAN	B6S	3510
CANB	BPM6A	7021
CANC	BM6A	5921
CB14	B5ES	6410
CL14	B5ES	6410
CLN	B6ES	7310
CLN14P	B5ES	6410
CLNH	B5ES	6410

LODGE	NGK → STOCK No.	
CLNY	BP5ES	6511
CN	B5HS	4210
CNY	BP5HS	4111
CSN	B4L	3112
CTY	BP5FS	3412
CV	AB6	2910
H	B6HS	4510
H12	D6HA	6512
H18	AB7	3010
HA	B7S	3710
HAN	B7S	3710
HAN/M	B7S	3710
HB12	D6HA	6512
HBAN	B6S	3510
HBL12	D8EA	2120
HBLN	B5ES	6410
HBN	B5HS	4210
HBSN	B6L	3212
HBTNY	AP6FS	2710
HBTY	BP5FS	3412
HBV	AB6	2910
HL	B6ES	7310
HL12	D9EA	2420
HL14	B6ES	7310
HL-E	B6ES	7310
HLN	B6ES	7310
HLNP	B6ES	7310
HLNY	BP6ES	7811
HN	B6HS	4510
HNY	BP6HS	4511
HT14	BP5FS	3412
HT18	AP6FS	2710
HTNY	AP6FS	2710
H-TY	BP6FS	3512
HV	AB7	3010

MARCHAL/VALEO	NGK → STOCK No.	
17C	AB7	3010
19C	AB7	3010
19E	AB7	3010
19L	AB7	3010
2/13	AB8	7909
2/32	B8HS	5510
2/32H	B8ES	2411
2/33	B8HS	5510
2/33H	B7ES	1111
20C	AB6	2910
20E	AB6	2910
20L	AB6	2910
21C	AB6	2910
21E	AB6	2910
21L	AB6	2910
22L	AB2	3020
22LM	AB2	3020
23F	A6FS	2210
34/5HS	BP6ES	7811
34C	B7S	3710
34CM	B7S	3710
34HS	B7ES	1111
34HSM	B7ES	1111
34S	B7HS	5110
35	B6HS	4510
35/1	BP6HS	4511
35/1B	BP6HS	4511
35/1D	BP6HS	4511
35/36D	B6HS	4510
35/36P	B6HS	4510
35/36R	B6HS	4510
35B	B6HS	4510
35C	B6S	3510
35CM	B6S	3510
35HA	BP6ES	7811
35HS	B6ES	7310
35M	B6HS	4510

MARCHAL/VALEO	NGK → STOCK No.	
35P	B6HS	4510
36	B5HS	4210
36B	B5HS	4210
36C	B4	3210
36CM	B4	3210
36D	B5HS	4210
36HS	B5ES	6410
36M	B5HS	4210
36P	B5HS	4210
37S	B5HS	4210
4N	B7HS	5110
5H	B7ES	1111
5N	BP6HS	4511
5N CYCLO	BP6HS	4511
64H	BP7ES	2412
67HP	BR8EIX	5044
6H	BP7ES	2412
6N	BP5HS	4111
70H	BP6ES	7811
76H	BP5ES	6511
7H	BP6ES	7811
84H	BP5ES	6511
88N	B5HS	4210
8H	BP6ES	7811
9H	BP5ES	6511
C64H	BP6EFS	3812
C68H	BP6EFS	3812
C7H	BP6EFS	3812
F70H	BCP7ES	5030
F74H	BCP6ES	4930
F80H	BCP7ES	5030
GT34	BP7HS	7811
GT34/2H	BP6ES	7811
GT34/5	BP6HS	4511
GT34/5D	BP6HS	4511
GT34/5H	BP6ES	7811
GT34/5HA	BP6ES	7811
GT34/5HD	BP6ES	7811
GT34D	BP7HS	5111
GT34H	BP7ES	2412
GT34HD	BP6ES	7811
GT35	BP5HS	4111
GT35D	BP5HS	4111
GT35H	BP5ES	6511
GT35HD	BP5ES	6511
H32RG	B9EG	3530
H33RG	B8EG	3430
H34F	B8ES	2411
HA32/2	B8ES	2411
HA32RS	B9EG	3530
HF34	B7ES	1111
HF34F	B8ES	2411
RR31HS	B10EG	3630
RR32HS	B9EGV	5827
RR33HSS	B8EGV	5627
SCGT34/5H	BP6EFS	3812
SCGT35H	BP6EFS	3812
V36A	B5HS	4210
V6N SOLEX	B5HS	4210

MARELLI	NGK → STOCK No.	
7LCR	BKR6E	6962
7LPR	BKR6E	6962
8LCR	BCPR7ES	3330
8LDCR	PTR5A-10	5055
8LPR	BCPR7ES	3330
AW56C	BM7A	6521
AW5C	BM6A	5921
CM1N	AB2	3020
CM2N	AB2	3020
CM3N	AB6	2910
CM4N	AB6	2910
CM5N	AB6	2910
CM6N	AB7	3010

MARELLI	NGK → STOCK No.	
CU7N	C7HSA	4629
CW101L	B85EGV	7498
CW10L	B8EG	3430
CW112L	B9EG	3530
CW11L	B9EG	3530
CW12L	B9EG	3530
CW12NV	BUH	2422
CW13L	B10EG	3630
CW14L	B10EG	3630
CW225A	B6HS	4510
CW250A	B7HS	5110
CW25N	B4H	4110
CW260N	B7HS	5110
CW2C	B2	3110
CW2CJ	B2	3110
CW2L	B4ES	4129
CW2N	B4H	4110
CW3C	B4	3210
CW3CJ	B4	3210
CW3CP	BP4	2911
CW3L	B4ES	4129
CW3N	B4H	4110
CW4A	B5ES	6410
CW4C	B4	3210
CW4CJ	B4	3210
CW4CP	BP4	2911
CW4L	B4ES	4129
CW4N	B4H	4110
CW4NJ	B4H	4110
CW55N	B5HS	4210
CW5C	B4	3210
CW5CP	BP5S	3011
CW5L	B5ES	6410
CW5LJ	B5ES	6410
CW5LP	BP5ES	6511
CW5LS	B5ES	6410
CW5LSZ	B5ES	6410
CW5N	B5HS	4210
CW5NJ	B5HS	4210
CW5NP	BP5HS	4111
CW5NR	BR5HS	3722
CW5NS	B5HS	4210
CW5NSZ	B5HS	4210
CW67L	B6ES	7310
CW67LP	BP6ES	7811
CW67N	BP6HS	4511
CW67NJ	B6HS	4510
CW67NR	BR6HS	3922
CW67P	BP5ES	6511
CW6C	B6S	3510
CW6CE	BM6A	5921
CW6CJ	B6S	3510
CW6L	B5ES	6410
CW6LJ	B5ES	6410
CW6LP	BP5ES	6511
CW6LR	BR5ES	4722
CW6LS	B5ES	6410
CW6LSZ	B5ES	6410
CW6N	B6HS	4510
CW6NE	BM6A	5921
CW6NJ	B6HS	4510
CW6NP	BP6HS	4511
CW6NPR	BPR6HS	7022
CW6NR	BR6HS	3922
CW75LP	BP6ES	7811
CW78L	B6ES	7310
CW78LP	BP6ES	7811
CW78LPR	BPR6ES	7822
CW78LPS	BP6ES	7811
CW7C	B6S	3510
CW7L	B6ES	7310
CW7LCR	BKR6E	6962
CW7LJ	B6ES	7310
CW7LP	BP6ES	7811

MARELLI	NGK → STOCK No.	
CW7LPH	BP6ES	7811
CW7LPR	BPR6ES	7822
CW7LR	BR6ES	4922
CW7N	B6HS	4510
CW7NJ	B6HS	4510
CW7NP	BP6HS	4511
CW7NPR	BPR6HS	7022
CW7NR	BR6HS	3922
CW89LP	BP7ES	2412
CW8CJ	B7S	3710
CW8L	B7ES	1111
CW8LCR	BCPR7ES	3330
CW8LJ	B7ES	1111
CW8LP	BP7ES	2412
CW8LPR	BPR7ES	2023
CW8LPS	BP7ES	2412
CW8N	B7HS	5110
CW8NP	BP7HS	5111
CW8NR	BR7HS	4122
CW9L	B8ES	2411
CW9LJ	B8ES	2411
CW9LP	BP8ES	2912
CW9N	B8HS	5510
CWC12NJ	B8HS	5510
CWC67NJ	B6HS	4510
CWC6NJ	B6HS	4510
CWC7NJ	B6HS	4510
CWC9NJ	B7HS	5110
CWF11L	BR8EIX	5044
CWP10L	BR9EIX	3981
CWP10N	BR9HIX	5687
CWP11L	B10EGV	5927
CWP8L	BR7EIX	6664
CWP8N	BR7HIX	7067
CWP9L	BR8EIX	5044
CWP9N	B8HVX	2634
CWP9N	BR8HIX	7001
CX6N	D6HA	6512
CX8L	D8EA	2120
CX8N	D8HA	7112
DW4CJR	BR6S	3522
F6NC	BP5HS	4111
F6NCR	BPR5HS	6222
F7LC	BP6ES	7811
F7LCR	BPR6ES	7822
F7NC	BP6HS	4511
F7NCR	BPR6HS	7022
F8LC	BP7ES	2412
F8LCR	BPR7ES	2023
FC6N	B5HS	4210
FC7N	B6HS	4510
FC9L	BP8ES	2912
SW5C	BM6F	6221
T7LC	BP6EFS	3812
T7LCR	BPR6EFS	3623
T8LC	BP7EFS	3526
TM4NP	AP6FS	2710
TW4LP	BP5EFS	3712
TW5NP	BP5FS	3412
TW6NP	BP6FS	3512
TW78LP	BP6EFS	3812
TW78LPR	BPR6EFS	3623
TW78NPR	BPR6FS	2623
TW7LP	BP6EFS	3812
TW7LPR	BPR6EFS	3623
TW7NP	BP6FS	3512

MAZDA	NGK → STOCK No.	
0190 18 110	B6HS	4510
0259 18 110	BP6ES	7811
0370 18 110	BPR6EIX	6637
0371 18 110	BPR5EIX-11	6597
0376 18 110	BPR7EIX	4055
0419 18 110	B7ES	1111

MAZDA	NGK → STOCK No.
0420 18 110	B8ES 2411
0512 18 110	B6ES 7310
0660 18 110	BP5ES 6511
0745 18 110	BP7ES 2412
1002 77 550	BP5EY 7327
1003 77 550	BP6EY 7727
1482 18 600A	BR8EQ 3328
1690 18 110	BPR6ES 7822
3648 18 600	BR7ET 4121
3649 18 600	BR8ET 4221
4885 18 110	BPR2ES 2264
4894 18 110	BP2ES 3467
8182 18 600	BR7EQ 5128
8344 18 600	BR9ET 4528
8914 18 110	BPR5ES 7422
A501 18 110	BP6E 7529
AY02 18 110	DCP7E 2363
AZ08 18 110	BPR5E 7075
B601 18 110	BPR5ES-11 4424
B695 18 110	BCPR6E 1269
B6B3 18 110	BCPR5E-11 1273
BP01 18 110	BKR5E-11 6953
BP03 18 110	BKR6E-11 2756
BP05 18 110	BKR7E-11 1283
BP13 18 110	BKR5E-11 6953
BP47 18 110	BKR5E 7938
BP49 18 110	BKR6E 6962
BP51 18 110	BKR7E 6097
F201 18 110	ZFR6A-11 1041
F203 18 110	ZFR5A-11 5084
F210 18 110	BCPR5E 1145
F220 18 110	BCPR6E-11 3132
F285 18 110	ZFR6F-11 4291
F287 18 110	ZFR5F-11 2262
F289 18 110	ZFR7F-11 2975
FE79 18 110	BPR6ES-11 4824
JE03 18 110	BCPR7E 1272
KJ11 18 110	PZFR6F 7550
L303 18 110	ITR5F13 6044
L3K9 18 110	ITR6A-8G 3787
L3K9 18 110A	ITR6A-8G 3787
L3Y2 18 110	ILTR5A-13G 3811
L3Y3 18 110	ILTR6A-8G 3787
L3YD 18 110	SILTR6A7G 95369
L813 18 110	ITR6F13 4477
N322 18 110	BR10ET 7480
N342 18 110	BUR9EQ 5483
N3A1 18 110	BUR9EQP 5255
N3A3 18 110	BUR8EQP 4582
N3Y4-18-110A	RE9B-T 2809
N3Z5-18-110	RE8C-L 5745
ZM0118110	IZFR5G 5887

MCC - see SMART

McCULLOCH	NGK → STOCK No.
9111-310002-CH	BPMR6F 1270

MEGA FIRE	NGK → STOCK No.
SE8JC	BM6A 5921

MERCEDES	NGK → STOCK No.
002 159 18 03	BP7ES 2412
002 159 22 03	BP5ES 6511
002 159 24 03	BP6ES 7811
002 159 27 03	BP7ES 2412
002 159 28 03	BP6ES 7811
002 159 29 03	BP5ES 6511
002 159 31 03	BP5ES 6511
002 159 41 03	BP6ES 7811
002 159 42 03	BP6ES 7811
002 159 48 03	BP5ES 6511
002 159 49 03	BP6EFS 3812
002 159 56 03	BP6EFS 3812

MERCEDES	NGK → STOCK No.
002 159 57 03	BP5EFS 3712
002 159 58 03	BP5EFS 3712
002 159 64 03	BP7EFS 3526
002 159 65 03	BP7EFS 3526
002 159 68 03	BP6EFS 3812
002 159 69 03	BP6EFS 3812
002 159 76 03	BP5EFS 3712
002 159 77 03	BCP5ES 7496
003 159 04 03	BP5EFS 3712
003 159 05 03	BP5EFS 3712
003 159 06 03	BP6EFS 3812
003 159 07 03	BP6EFS 3812
003 159 08 03	BP7EFS 3526
003 159 12 03	BP6ESZ 7639
003 159 13 03	BP6ESZ 7639
003 159 14 03	BP7ES 2412
003 159 16 03	BCP6ES 4930
003 159 30 03	BCP5ES 7496
003 159 31 03	BCP6ES 4930
003 159 33 03	BP7EFS 3526
003 159 34 03	BP6EFS 3812
003 159 35 03	BP6EFS 3812
003 159 36 03	BP5EFS 3712
003 159 37 03	BCP5ES 7496
003 159 40 03	BP5EFS 3712
003 159 41 03	BP5EFS 3712
003 159 42 03	BCP5ES 7496
003 159 45 03	BP6ESZ 7639
003 159 56 03	BP7ES 2412
003 159 57 03	BP6ESZ 7639
003 159 75 03	BKUR5ET 2789
003 159 78 03	BKUR6ET-10 2397
003 159 91 03	BKR5EKUP 2890
003 159 97 03	IFR6D10 5344
004 159 13 03	ILFR6A 3588
004 159 14 03	IFR6Q-G 5648
004 159 20 03	IFR6D10 5344
004 159 25 03	SILZKR7A-S 7718
004 159 30 03	BKR6EZB 4293
004 159 30 03 26	BKR6EZB 4293
004 159 36 03	BKR6EZB 4293
004 159 39 03	ILZKAR7A10 6043
004 159 44 03	PLKR7B8E 94716
004 159 45 03	ILFR6A 3588
004 159 49 03	PLKR7A 4288
004 159 58 03	PLKR7B8E 94716

MERCURISER NGK → STOCK No.

33-104	BR7ES 5122
33-11458M	B6HS-10 1052
33-12127	BP6HS-10 6326
33-123	BR6ES 4922
33-12343	BP8HS-10 3823
33-12343B	BP8HS-10 3823
33-136862	BU8H 6431
33-136862B	BU8H 6431
33-14	BP5S 3011
33-14103550	BUZHW 2147
33-14103568	BUZ8H 7447
33-14103570	BUZHW-2 2173
33-14814548	BPZ8HS-10 3133
33-14814568	BPZ8HS-15 3180
33-17719547	BPR7HS-10 1092
33-18	BPR4FS-11 2527
33-18S	BPR4FS-11 2527
33-19424	BP8HS-15 6729
33-19796	BPR6HS-10 2623
33-306	B6HS 4510
33-312	BP6HS-10 6326
33-327	BPR6HS 7022
33-328	BP7HS 5111
33-33828C	BZ7HS-10 3579
33-400	BR6FS 4323
33-400S	BR6FS 4323

MERCURISER	NGK → STOCK No.
33-401	BP6EFS 3812
33-406	BPR6FS 2623
33-41263B	B7HS-10 2129
33-41263M	B7HS-10 2129
33-592	BR6S 3522
33-59571	BR6FS 4323
33-59571B	BR6FS 4323
33-63	BP5S 3011
33-670	R5673-8 4140
33-803507	DCPR6E 3481
33-807C	B8HS 5510
33-807S	B8HS 5510
33-809679	BR9ES 5722
33-809679B	BR9ES 5722
33-809680	BR8ES 5422
33-809680B	BR8ES 5422
33-811	B7HS 5110
33-811S	B7HS 5110
33-813413	B7S 3710
33-8134141	BP7HS 5111
33-813415	B8S 3810
33-813421	R5673-8 4140
33-813423	BPR6HS 7022
33-813469	B6S 3510
33-8134711	BR6ES 4922
33-814	BPR7HS-10 1092
33-816336	BPR6EFS 3623
33-8167372	BR8H-N-10 4838
33-8167372B	BR8H-N-10 4838
33-8168372	BPZ8H-N-10 4495
33-8168372B	BPZ8H-N-10 4495
33-818	BR9ES 5722
33-818S	BR9ES 5722
33-821916	BR7HS 4122
33-821C	B9HS-10 3626
33-821S	B9HS-10 3626
33-823	B6S 3510
33-82370M	B6HS 4510
33-82370M1	B6HS 4510
33-82371B	B7HS 5110
33-82371M	B7HS 5110
33-82372M	B8HS 5510
33-823S	B6S 3510
33-824	BUHX 2522
33-825C	B7S 3710
33-825S	B7S 3710
33-827858	DPR6EA-9 5531
33-827859	CR6HS 7023
33-827C	BUHW 2622
33-828C	BZ7HS-10 3579
33-828S	BZ7HS-10 3579
33-833C	BUHW-2 5626
33-833S	BUHW-2 5626
33-838	BUZHW-2 2173
33-841C	B6S 3510
33-84409B	B8HS-10 5126
33-84409M	B8HS-10 5126
33-84675M	B5HS 4210
33-8556721	PZFR5F-11 4363
33-8557171	ZFR5F-11 2262
33-859495	LFRA5A-11 6376
33-874	BR7HS 4122
33-876	BUZ8H 7447
33-880	BR8ES 5422
33-881284	LFRA6A-11 3672
33-883	BR7HS 4122
33-885C	BU8H 6431
33-885S	BU8H 6431
33-886	BUZ8H 7447
33-896	B5HS 4210
33-898	BUZHW 2147
33-918	ZFR6F-11 4291
33-924	BP8HS-15 6729
33-936C	BP8HS-10 3823

MERCURISER	NGK → STOCK No.
33-936S	BP8HS-10 3823
33-938	BPZ8HS-10 3133
33-938	BPZ8HS-10 3133
33-939	BPZ8HS-15 3180
33-941	BR8HS 4322
33-97180	BUHW 2622
33-97180B	BUHW 2622
33-97182	BUHW-2 5626
33-97182B	BUHW-2 5626
33-97184	BP7HS-10 7829
33-97186	B9HS-10 3626
33-97186B	B9HS-10 3626
33-97389	BPR6FS 2623

MINI (BMW)	NGK → STOCK No.
12 12 0 030 548	BKR6EQUP 3199
12 12 0 031 708	BKR7EQUP 4285
12 12 0 034 098	PLZKBR7A-G 5843
12 12 0 035 531	ILZKBR7A-8G 5992

MITSUBISHI	NGK → STOCK No.
1822A005	ILZFR6C-K 6645
18822A021	ILKR8E6 1422
1822A022	ILFR7H 5245
MD 313 443	PPR6G-11 5555
MD 314 766	BKR7EKC-N 2095
MD 338 991	PGR7A 3200
MD 360 019	IZFR6B 3116
MD 360 383	IZFR5B 4080
MD 371 434	IGR7A 6687
MD 372 588	IFR6E11 6741
MD 374 841	IGR7A-G 3106
MN 119 487	IFR6S 99404
MN 119 500	IGR6A11 5743
MN 137 919	LFRA6C-11 5788
MN 158 596	LZFR6AI 3656
MN 163 235	FR5E1 1313
MS 851 022	BP5ES 6511
MS 851 023	BP6ES 7811
MS 851 024	BP7ES 2412
MS 851 102	BP5EY 7327
MS 851 104	BP6EY 7727
MS 851 111	B4 3210
MS 851 113	B6S 3510
MS 851 121	BP4 2911
MS 851 126	BPR6E 6464
MS 851 132	B5HS 4210
MS 851 133	B6HS 4510
MS 851 134	B7HS 5110
MS 851 162	B5ES 6410
MS 851 163	B6ES 7310
MS 851 164	B7ES 1111
MS 851 165	B8ES 2411
MS 851 174	BR7ES 5122
MS 851 182	BP5ES 6511
MS 851 183	BP6ES 7811
MS 851 184	BP7ES 2412
MS 851 192	BP6ES 7811
MS 851 232	BPR5ES 7422
MS 851 233	BPR6ES 7822
MS 851 234	BPR7ES 2023
MS 851 235	BPR5ES 7422
MS 851 236	BPR6ES 7822
MS 851 237	BPR5ES-11 4424
MS 851 238	BPR6ES-11 4824
MS 851 239	BPR7ES-11 7226
MS 851 243	BP5EY 7327
MS 851 263	G2Z 3320
MS 851 283	BP6E 7529
MS 851 286	BP5EY 7327
MS 851 287	BP6EY 7727
MS 851 301	PGR5A-11 3573
MS 851 317	DCPR7E 3932
MS 851 327	DCPR7EVX 1179

MITSUBISHI	NGK → STOCK No.	
MS 851 327	DCPR7EIX	6046
MS 851 332	PFR6B-11	4014
MS 851 335	PFR5J-11	4642
MS 851 336	PFR6J-11	2743
MS 851 347	PFR7M	4877
MS 851 352	BK6E	3536
MS 851 357	BKR5E-11	6953
MS 851 358	BKR6E-11	2756
MS 851 367	BKR5E	7938
MS 851 368	BKR6E	6962
MS 851 403	BPR6ES-11	4824
MS 851 408	BPR6ES-11	4824
MS 851 412	BPR5ES	7422
MS 851 413	BPR6ES	7822
MS 851 414	BPR7ES	2023
MS 851 417	BPR5ES-11	4424
MS 851 418	BPR6ES-11	4824
MS 851 419	BPR7ES-11	7226
MS 851 454	BR7ES	5122
MS 851 473	PFR6B-11	4014
MS 851 473	PFR6J-11	2743
MS 851 478	BPR6ES-11	4824
MS 851 502	PFR6J-11	2743
MS 851 722	BK6E	3536
MS 851 727	BKR5E-11	6953
MS 851 728	BKR6E-11	2756
MS 851 737	BKR5E	7938
MS 851 738	BKR6E	6962
MS 851 882	BPR7EKN	7738
Z 2152 944	BPR6ES-11	4824
Z 2152 945	BPR6ES	7822
Z 2152 946	BR7ES	5122
Z 2152 947	BPR7ES	2023
Z 2152 948	BPR7ES-11	7226
Z 2152 949	BCPR7ES-11	1095
Z 2152 950	BCPR6ES-11	7121

MONTESA	NGK → STOCK No.	
98059-56916-00	CR6EH-9	2688

MOPAR - see CHRYSLER GROUP

MOTORCRAFT	NGK → STOCK No.	
A11	B2	3110
A11NX	BM4A	5628
A11U	B2	3110
A11X	B2	3110
A1CU	B8S	3810
A21X	B8S	3810
A22NX	BPM7A	7321
A2NX	BM7A	6521
A3CU	B6S	3510
A3NX	BM6A	5921
A3X	B6S	3510
A42	BP5S	3011
A42CU	BP5S	3011
A5	B6S	3510
A5CU	B6S	3510
A5X	B6S	3510
A52	BP5S	3011
A52CU	BP5S	3011
A7	B4	3210
A7LM	B4LM	3410
A7N	BM6A	5921
A7NU	BM6A	5921
A7NX	BM6A	5921
A7U	B4	3210
A7X	B4	3210
A82	BP4	2911
A9	B4	3210
A901	B8S	3810
A9X	B4	3210
AE1C	B7HS	5110
AE1X	B7HS	5110

MOTORCRAFT	NGK → STOCK No.	
AE2	B7HS	5110
AE2C	B7HS	5110
AE2X	B7HS	5110
AE22	BP6HS	4511
AE22C	BP6HS	4511
AE3	B6HS	4510
AE3X	B6HS	4510
AE32	BP6HS	4511
AE32C	BP6HS	4511
AE3C	B6HS	4510
AE4	B5HS	4210
AE4X	B5HS	4210
AE42	BP5HS	4111
AE6	B5HS	4210
AE62	BP5HS	4111
AE7	B4H	4110
AE901	B9HS	5810
AE901X	B9HS-10	3626
AER32	BPR6HS	7022
AER4	BR5HS	3722
AER4X	BR5HS	3722
AF12	BP7FS	3612
A-2	B7FS	3027
AF22	BP6FS	3512
AF32	BP6FS	3512
AF3NX	BM7F	6421
AF42	BP5FS	3412
AF5NX	BM6F	6221
AG1	B8ES	2411
AG1C	B8ES	2411
AG1X	B8ES	2411
AG12	BP7ES	2412
AG12C	BP7ES	2412
AG12CU	BP7ES	2412
AG2	B7ES	1111
AG2C	B7ES	1111
AG2CU	B7ES	1111
AG2X	B7ES	1111
AG203	B11EGP	2191
AG22	BP6ES	7811
AG22C	BP6ES	7811
AG22CU	BP6ES	7811
AG23	B7ECS	2528
AG252	BP6ES	7811
AG252C	BP6ES	7811
AG3	B6ES	7310
AG3C	B6ES	7310
AG3X	B6ES	7310
AG32A	BP6ES	7811
AG32C	BP6ES	7811
AG32CU	BP6ES	7811
AG4	B5ES	6410
AG403	B10EGP	5224
AG403C	B10EGP	5224
AG42	BP5ES	6511
AG42CU	BP5ES	6511
AG44	ZGR5C	6334
AG44CU	BP5EY	7327
AG5	B5ES	6410
AG501X	B10EGV	5927
AG52	BP5ES	6511
AG54	ZGR5C	6334
AG5CU	B5ES	6410
AG7	B5ES	6410
AG701	B9ES	2611
AG701C	B9ES	2611
AG701CU	B9ES	2611
AG701X	B9EGV	5827
AG9	B4ES	4129
AG9U	B4ES	4129
AG901	B9ES	2611
AG901C	B9ES	2611
AG901CU	B9ES	2611
AG901X	B8EGV	5627

MOTORCRAFT	NGK → STOCK No.	
AG902	BP8ES	2912
AG903	B8EG	3430
AGF12	BP7EFS	3526
AGF12C	BP7EFS	3526
AGF22C	BP6EFS	3812
AGF32CU	BP6EFS	3812
AGFS22C1	BPR5EFS	2223
AGFS22F13J	TR6AP-13	5809
AGFS22FE13J	PTR6F-13	7569
AGFS22IPJ	ITR6F13	4477
AGKO	BUE	2322
AGN42	BP5ES	6511
AGP12C	BCP7ES	5030
AGP22C	BCP6ES	4930
AGP701C	R7435-10	4897
AGPR12C	BCPR7ES	3330
AGPR12PP8	PFR7B	4853
AGPR22C	BKR6E	6962
AGPR22C1	BCPR6ES-11	7121
AGPR22CD	BKR6E	6962
AGPR22CD1	BCPR6ES-11	7121
AGPR22PP	PFR6B-11	4014
AGPR22PPJ	PFR6B-11	4014
AGPR32C	BKR6E	6962
AGPR32CD1	BCPR6ES-11	7121
AGPR32PD	BKR5EKUP	2890
AGPR902P	R7436-9	4899
AGPS22C	BCPR6ES	6130
AGPS22P1	BKR6EIX	6418
AGPS22PP1	PFR6B	3500
AGPS32C	BCPR6ES	6130
AGPS44F	PZFR5D-11	7968
AGPS44F11J	PZFR5D-11	7968
AGR1X	BR8ES	5422
AGR12C	BPR7ES	2023
AGR16C	BR8ET	4221
AGR2C	BR7ES	5122
AGR21	BR6ES	4922
AGR22	BPR6ES	7822
AGR22C	BPR6ES	7822
AGR22CU	BPR6ES	7822
AGR3X	BR6ES	4922
AGR31	BR6ES	4922
AGR32	BPR6ES	7822
AGR32C	BPR6ES	7822
AGR32CU	BPR6ES	7822
AGR34CU	BPR6EY	6427
AGR41	BR5ES	4722
AGR42	BPR5ES	7422
AGR42C	BPR5ES	7422
AGR42CU	BPR5ES	7422
AGR44CU	BPR5EY	2828
AGR44CU-11	BPR5EY-11	3028
AGR51	BR5ES	4722
AGR52	BPR5ES	7422
AGR701X	BR9EIX	3981
AGR82	BPR4ES	7222
AGR901X	BR8EIX	5044
AGRF22C	BPR6EFS	3623
AGRF22C1	BPR6EFS	3623
AGRF22PP1	PTR5D-10	3784
AGRF32	BPR6EFS	3623
AGRF32C1	BPR6EFS	3623
AGRF42	BPR5EFS	2223
AGRF52	BPR5EFS	2223
AGRP52	ZFR4F-11	4043
AGS22C	BPR6ES	7822
AGS32C	BPR5ES	7422
AGS32C-11	BPR5ES-11	4424
AGSF22PPJ	PTR6F-13	7569
AGSF32C	BPR5EFS	2223
AGSF32FM	PTR5D-13	6644
AGSP32	BCPR6ES-11	7121

MOTORCRAFT	NGK → STOCK No.	
AGSP32C	BCPR6ES-11	7121
AGSP33C	ZFR6F-11	4291
AGSP52	BKR5E	7938
AL11	B4L	3112
AL5	B6L	3212
AL5X	B6L	3212
AL7	B6L	3212
AL7U	B6L	3212
AL7X	B6L	3212
AL9	B4L	3112
AL9X	B4L	3112
AR21X	BR6S	3522
AR31	BR6S	3522
AR41	BR6S	3522
AR42	BP5S	3011
AR51	BR6S	3522
AR52	BP5S	3011
AR7N	BMR6A	7421
AR82	BP4	2911
ARF2	BR6FS	4323
ARF22	BPR6FS	2623
ARF22C	BPR6FS	2623
ARF22CU	BPR6FS	2623
ARF3	BR6FS	4323
ARF32	BPR6FS	2623
ARF32-6	BPR6FS	2623
ARF32C-6	BPR6FS	2623
ARF32M	BPR6FS	2623
ARF4	BR5FS	4123
ARF41CU15	BR5FS-15	2224
ARF42	BPR5FS	2423
ARF42-6	BPR5FS-15	3124
ARF42CU	BPR5FS	2423
ARF4-6	BR5FS-15	2224
ARF52	BPR4FS	1127
ARF52-6	BPR4FS-15	2727
ARF6	BR5FS	4123
ARF62	BPR4FS	1127
ARF62-6	BPR4FS-15	2727
ARF8	BR5FS	4123
ARF8-6	BR5FS-15	2224
ASF32	BPR6FS	2623
ASF32C	BPR6FS	2623
ASF32M	BPR6FS	2623
ASF42	BPR5FS-11	2924
ASF42-6C	BPR5FS-15	3124
ASF42C	BPR5FS-11	2924
ASF52	BPR4FS	1127
ASF52-6	BPR4FS-15	2727
ASF52C	BPR5FS	2423
AT1	B8S	3810
AT10	B2	3110
AT2	B7S	3710
AT3	B6S	3510
AT4	B6S	3510
AT42	BP5S	3011
AT6	B6S	3510
AT8	B4	3210
ATL3	B6L	3212
ATL4	B6L	3212
ATL8	B4L	3112
AV1X	B8HS	5510
AV22CU	BP6HS	4511
AV2CU	B7HS	5110
AV2X	B7HS	5110
AV3CU	B6HS	4510
AV4	B5HS	4210
AV42	BP5HS	4111
AV52	BP5HS	4111
AV6	B4H	4110
AV6CU	B4H	4110
AV701CU10	B9HS-10	3626
AV82	BP4HS	3611
AV901CU	B9HS	5810

MOTORCRAFT	NGK → STOCK No.	
AV901X-4	B9HS-10	3626
AVKO	BUH	2422
AVKOD	BUHW	2622
AVZKO	BUHX	2522
AWRF32	BPR6EFS	3623
AWRF42	BPR5EFS	2223
AWSF22C	BPR6EFS	3623
AWSF22FS	PTR6D-13	5598
AWSF32	BPR6EFS	3623
AWSF32C	BPR6EFS	3623
AWSF32F	PTR5D-10	3784
AWSF32P	PTR5D-10	3784
AWSF32PP	PTR5D-10	3784
AWSF42	BPR5EFS	2223
AWSF42C	BPR5EFS	2223
AWSF52C	BPR5EFS	2223
AWSFA32C	BPR5EFS	2223
AYFS092FEC	PLTR6A-10G	3587
AYFS22C	TR5A-10	0005
AYFS22CB	TR5B-13	4559
AYFS22FE1J	PLTR6A-10G	3587
AYFS22P1	PTR5A-10	5055
AYFS22PP1	PTR5A-10	5055
AYFS32CJ	TR5B-13	4559
AYRF22PP	PTR5A-10	5055
AYSF32YPC	ILTR5A-13G	3811
AZ2	B7S	3710
AZ3	B6S	3510
AZ9	B4	3210
AZ901	B8S	3810
AZFS22PP	PTR5A-10	5055
AZFS32FE	PTR5A-10	5055
B2W	AB8	7909
B3W	AB7	3010
B3X	AB7	3010
B4X	AB7	3010
B6W	AB6	2910
B8X	AB6	2910
BF12	AP8FS	2227
BF22	AP6FS	2710
BF22C	AP6FS	2710
BF22CU	AP6FS	2710
BF22CX	AP6FS	2710
BF22X	AP6FS	2710
BF32	AP6FS	2710
BF32CU	AP6FS	2710
BF32CX	AP6FS	2710
BF32X	AP6FS	2710
BR8	AB6	2910
BRF22	APR6FS	2922
BRF22C	APR6FS	2922
BRF32	APR6FS	2922
BRF42	APR5FS	3122
BRF82	APR5FS	3122
BSF32C	APR6FS	2922
BSF42C	APR5FS	3122
BSF82	APR5FS	3122
BSF92	APR5FS	3122
BT10	AB6	2910
BT15	AB2	3020
BT2	AB8	7909
BT3	AB7	3010
BT4	AB7	3010
BT6	AB6	2910
BT8	AB6	2910
BT9	AB6	2910
BTF3	A6FS	2210
BTF31	A6FS	2210
BTF6	A6FS	2210
BTRF42	APR5FS	3122
BZ8	AB6	2910
HG2	D8EA	2120
HG22	D8EA	2120
HG2CU	D8EA	2120

MOTORCRAFT	NGK → STOCK No.	
HGR2C	DR8ES-L	2923
HV2	D8HA	7112
HV22	D6HA	6512
HV3	D6HA	6512
PV2	C7HSA	4629
PV3	C6HSA	3228
TT4	G2Z	3320
TT8	G2Z	3320
YN2F-12405A2A	TR5B-13	4559

MV AGUSTA	NGK → STOCK No.	
7699116	CR9EKB	2305

NANDA - see CHINESE BRANDS

NHSP LD - see CHINESE BRANDS

NIPPON DENSO - see DENSO

NISSAN NGK → STOCK No.

-01P15	BCPR5ES-11	3524
-01P16	BCPR6ES-11	7121
-01P17	BCPR7ES-11	1095
-02P15	BCPR5E-11	1273
-02P16	BCPR6E-11	3132
-10F15	BCP5ES	7496
-10F16	BCP6ES	4930
-10F17	BCP7ES	5030
-12E15	BCPR5ES	6130
-12E16	BKR6E	6962
-12E17	BCPR7ES	3330
-1P115	PFR5G-11	2647
-1P116	PFR6G-11	5555
-1P117	PFR7G-11S	7772
-20J05	BKR5E	7938
-20J06	BKR6E	6962
-20J07	BKR7E	6097
22401-5M015	PLFR5A-11	6240
22401-BC01B	LFR5E-11	1669
22401-CK87B	PLZKAR6A-11	5118
22401-FU412	FR2A-D	4768
22401-FU42A	FR2B-D	1598
22401-JA01B	DILKAR6A11	9029
22401-JF01D	DILKAR8A8	93026
22401-JK01D	DF8H-11B	1305
22401-RS345-8	R7345-8	4379
-30R15	ZFR5E-11	4435
-50Y05	BKR5E-11	6953
-50Y06	BKR6E-11	2756
-53J05	BKR5EY	7390
-53J06	BKR6EY	3696
-53J16	PFR6B-9	4377
-53J66	PFR6B-9	4377
-58S16	PFR6A-11	4045
-85E15	BKR5E-11	6953
-85E16	BKR6E-11	2756
-85E17	BKR7E-11	1283
-99B07	BCPR7ES-11	1095
-99B09	BCPR6ES-11	7121
-99B12	BCPR5ES-11	3524
-F2000	BPR4ES	7222
-P8315	BPR5ES-11	4424
-P8316	BPR6ES-11	4824
-P8317	BPR7ES-11	7226
-S2000	BPR5ES	7422
-S2100	BPR6ES	7822
-V1414	BPR4ES	7222
-V1415	BPR5ES	7422
-V1416	BPR6ES	7822
-V1417	BPR7ES	2023
-W8915	BP5ES	6511
-W8916	BP6ES	7811
-W8917	BP7ES	2412

OMC	NGK → STOCK No.	
115206	BP6HS	4511
387694	B7HS	5110
437929	BPR7HS	6422
445098	D6HA	6512
502177	B6HS	4510
502194	B7HS-10	2129
502196	BR6S	3522
502894	BUZ8H	7447
503948	BPR6HS	7022
503949	BR6HS	3922
503950	BR6HS	3922
504082	BR6HS	3922
509921	BUHW	2622
509922	BUHW-2	5626
509924	BUZ8H	7447
509925	BZ7HS-10	3579
509926	BUHXW-1	5526
509928	B6S	3510
509929	B7HS	5110
584918	DCPR7E	3932
771770	BUZHW-2	2173

OPEL - see VAUXHALL

OREGON - see BRISK

PAL	NGK → STOCK No.	
14-5	B4H	4110
14-5Y	BP4HS	3611
14-7	B5HS	4210
14-7Y	BP5HS	4111
14-8	B6HS	4510
14-8R	BR6HS	3922
14-8Y	BP6HS	4511
14-9	B8HS	5510
14-9R	BR7HS	4122
14-9Y	BP7HS	5111
14K-5	B4	3210
14K-5Y	BP4	2911
14K-7Y	BP5S	3011
14K-8	B6S	3510
14L-5	B5ES	6410
14L-5R	BR5ES	4722
14L-5Y	BP5ES	6511
14L-7	B6ES	7310
14L-7R	BR6ES	4922
14L-7Y	BP6ES	7811
14L-8	B6ES	7310
14L-8Y	BP6ES	7811
14L-9	B7ES	1111
14L-9Y	BP7ES	2412
17-9	B7HS	5110
18-5	AB6	2910
18-5R	AB6	2910
18-7	AB7	3010
B14YC	DPR8EA-9	4929
D14YC	BCP7ES	5030
D15YC	BCP6ES	4930
D17YC	BCP5ES	7496
DR14YC	BCPR7ES	3330
DR15YC	BKR6E	6962
DR17YC	BCPR5ES	6130
G14YC	BP7EFS	3526
G15YC	BP6EFS	3812
G17YC	BP5EFS	3712
K17C	B6S	3510
K17Y	BP5S	3011
K19	B4	3210
L08W	B11EGV	5831
L12W	BR9EIX	3981
L12YC	BP9ES	7526
L14C	B8ES	2411
L14YC	BP7ES	2412
L15C	B7ES	1111

PAL	NGK → STOCK No.	
L15W	BR8EIX	5044
L15YC	BP6ES	7811
L17C	B6ES	7310
L17YC	BP5ES	6511
L19C	B5ES	6410
L5Y	BP5ES	6511
L7Y	BP6ES	7811
L8	B6ES	7310
L8Y	BP6ES	7811
L9Y	BP7ES	2412
LR12YC	BPR8ES	3923
LR14YC	BPR7ES	2023
LR15YC	BPR6ES	7822
N12YC	BP8ES	2912
N14C	B9HS	5810
N14YC	BP7HS	5111
N15C	B7ES	1111
N15YC	BP6HS	4511
N17C	B6HS	4510
N17Y	BP4HS	3611
N17YC	BP5HS	4111
N19	B4H	4110
N19C	B5HS	4210
N7	B6HS	4510
N7Y	BP6HS	4511
N8	B7HS	5110
N8Y	BP7HS	5111
NR12YC	BPR8HS	3725
NR15YC	BPR6HS	7022
P15	BM7A	6521
P15Y	BPM7A	7321
P17	BM6A	5921
P17Y	BPM6A	7021
PR15Y	BPMR7A	4626
PR17Y	BPMR6A	6726
S14L-13	B8EG	3430
S14L-15	B9EG	3530
S14L-17	B10EG	3630
U17	BM6F	6221

PEUGEOT NGK → STOCK No.

5960.83	LZKAR7A	6799
5960.F0	BKR6EZ	4619
5960.G1	LZKAR7A	6799
5962.05	BP6EFS	3812
5962.09	BP6EFS	3812
5962.13	BP6ES	7811
5962.14	BP6EFS	3812
5962.15	BP6EFS	3812
5962.16	BP6ES	7811
5962.21	BP6ET	1263
5962.22	BPR6EIX	6637
5962.5G	BKR6EZ	4619
5962.6V	BKR6EZ	4619
5962.71	BKR6ES	3783
5962.72	BP6EFS	3812
5962.7S	BKR6EZ	4619
5962.80	BP6HS	4511
5962.82	BP6ES	7811
5962.87	BP6EFS	3812
5962.88	BP8ES	2912
5962.90	BP6HS	4511
5962.94	BP7ES	2412
5962.98	BP7ES	2412
5962.A1	BP7ES	2412
5962.A2	BP6ES	7811
5962.A3	BP6HS	4511
5962.A5	PLZKBR7A-G	5843
5962.AO	BP7ES	2412
5962.C5	BKR6ES	3783
5962.C6	BKR6ES	3783
5962.CO	BP5EFS	3712
5962.E2	BCP6ES	4930
5962.F7	BCP6ES	4930

PEUGEOT	NGK → STOCK No.	
5962.F8	BCP6ES	4930
5962.G8	BP7ES	2412
5962.H2	BKR6ES	3783
5962.H8	BKR5E	7938
5962.H9	BCPR5ES	6130
5962.J9	BKR6ES	3783
5962.JO	BCP6ES	4930
5962.K1	BCPR7ES	3330
5962.K3	BCP7ET	2078
5962.K4	BKR6ES	3783
5962.K6	BKR6ES	3783
5962.K7	BCPR6ET	2197
5962.KO	BCPR7ES	3330
5962.R5	BCPR6ET	2197
5962.R9	BKR6ES	3783
5962.S2	BKR6E	6962
5962.S4	BKR5E	7938
5962.T8	BKR6ES	3783
5962.V6	BKR5E	7938
5962.V7	BKR6ES	3783
5962.V8	BCPR7ES	3330
5962.W4	BCPR6ET	2197
5962.W6	BCPR7ES	3330
5962.W7	BCPR7ES	3330
5962.W9	BKR5EK	7956
5962.X5	BCP6ES	4930
5962.Y2	BKR5EK	7956
5962.Y8	BKR6EK	2288
5962.ZO	BKR6EK	2288

PORSCHE	NGK → STOCK No.	
999 170 223 90	BKR7EQUP	4285

PRESTOLITE	NGK → STOCK No.	
10E2	C7HSA	4629
10E3	C7HSA	4629
10E4	C6HSA	3228
12E2	D8HA	7112
12E22	D6HA	6512
12E3	D8HA	7112
12E42	D6HA	6512
12G2	D8EA	2120
12G3	D8EA	2120
14-11	B2	3110
14-11N	BPM6A	7021
14-11X	B2	3110
14-2X	B6S	3510
14-3	B6S	3510
14-3N	BM7A	6521
14-3X	B6S	3510
14-4	B6S	3510
14-42	BP5S	3011
14-5	B6S	3510
14-52	BP5S	3011
14-5X	B6S	3510
14-7	B4	3210
14-7N	BM6A	5921
14-7X	B4	3210
14-82	BP4	2911
14-9	B4	3210
14-9X	B4	3210
14E01	BUH	2422
14E1	B8HS	5510
14E2	B7HS	5110
14E22	BP7HS	5111
14E3	B6HS	4510
14E32	BP6HS	4511
14E4	B5HS	4210
14E42	BP6HS	4511
14E52	BP5HS	4111
14E6	B5HS	4210
14E62	BP5HS	4111
14E82	BP4HS	3611
14ER4	BR6HS	3922

PRESTOLITE	NGK → STOCK No.	
14ER6	BR6HS	3922
14F22	BP6FS	3512
14F32	BP6FS	3512
14F3N	BM7F	6421
14F42	BP5FS	3412
14F52	BPR4FS	1127
14F7N	BM6F	6221
14G01	BUE	2322
14G1	B8ES	2411
14G12	BP8ES	2912
14G2	B7ES	1111
14G22	BP6ES	7811
14G3	B6ES	7310
14G32	BP5ES	6511
14G4	B6ES	7310
14G42	BP5ES	6511
14G5	B5ES	6410
14G52	BP5ES	6511
14G7	B5ES	6410
14G902	BP8ES	2912
14GF22	BP6EFS	3812
14GR22	BPR6ES	7822
14GR32	BPR5ES	7422
14GR4	BR6ES	4922
14GR42	BPR5ES	7422
14GR52	BPR4ES	7222
14GR53	ZGR5C	6334
14GR7	BR5ES	4722
14GRF22	BPR6EFS	3623
14GRF32	BPR5EFS	2223
14GRF52	BPR5EFS	2223
14L4	B6L	3212
14L7	B6L	3212
14L9	B4L	3112
14R3	BR6S	3522
14R32	BP5S	3011
14R4	BR6S	3522
14R42	BP5S	3011
14R5	BR6S	3522
14R52	BP4	2911
14R53	BP4	2911
14R7N	BM6A	5921
14R8	B6S	3510
14RF22	BPR6FS	2623
14RF32	BPR5FS	2423
14RF32-6	BPR5FS-15	3124
14RF32A	BPR5FS-15	3124
14RF42	BPR5FS	2423
14RF42-6	BPR5FS-15	3124
14RF42A	BPR5FS-15	3124
14RF52	BPR4FS	1127
14RF52-6	BPR4FS-15	2727
14RF52A	BPR4FS-15	2727
14RF62	BPR4FS	1127
14RF62-6	BPR4FS-15	2727
14RF62A	BPR4FS-15	2727
18-10	AB6	2910
18-3	AB6	2910
18-4	AB6	2910
18-8	AB6	2910
18-9	AB6	2910
18F22	AP6FS	2710
18F3	A6FS	2210
18F32	AP6FS	2710
18F6	A6FS	2210
18RF32	APR6FS	2922
18RF42	APR6FS	2922
18RF82	APR6FS	2922
78-10	G2Z	3320
78-8	G2Z	3320

PROTECNICA	NGK → STOCK No.	
4708	BR2LM	5798
4843	BPM7A	7321

PROTON	NGK → STOCK No.	
8200030765	LZKAR7A	6799
MS851232E	BPR5ES	7422
MS851233E	BPR6ES	7822
MS851358E	BKR6E-11	2756
PVW811750	BPR6EF-11	95420
LAP6FS	AP6FS	2710
LBCPR6ES	BCPR6ES	2330
LBCP6ES	BCP6ES	4930
LBPR6EFS	BPR6EFS	3623
LBP5ES	BP5ES	6511
LBP6EFS	BP6EFS	3812
LBP6ES	BP6ES	7811
PVW811750	BPR6EF-11	95420

RAM - see CHRYSLER GROUP

RENAULT	NGK → STOCK No.	
77 00 101 401	BCPR5ES	6130
77 00 103 502	BPR5ES	7422
77 00 103 503	BPR5ES	7422
77 00 103 533	BKR5EK	7956
77 00 107 916	BKR5EK	7956
77 00 260 637	BCP7ET	2078
77 00 266 295	BPR6EFS	3623
77 00 267 140	BPR6EFS	3623
77 00 267 805	BP7EFVX	3344
77 00 267 805	TR7IX	3690
77 00 273 462	BKR6E	6962
77 00 273 698	BKR6EIX	6418
77 00 500 155	BKR6EZ	4619
77 00 500 192	LFRA4P-11	5613
77 00 553 622	BP6ES	7811
77 00 565 155	BR9EIX	3981
77 00 587 168	BP6HS	4511
77 00 714 540	BPR6EFS	3623
77 00 722 095	BP6EFS	3812
77 00 724 821	BP6ES	7811
77 00 725 302	BPR5ES	7422
77 00 726 503	BP7EFS	3526
77 00 727 383	BPR6ES	7822
77 00 731 583	BP7EFS	3526
77 00 732 626	BP8ES	2912
77 00 733 422	BP5HS	4111
77 00 736 149	BP7EFS	3526
77 00 736 150	BP7EFS	3526
77 00 737 457	BP7EFS	3526
77 00 737 458	BP6EFS	3812
77 00 737 459	BP7ES	2412
77 00 737 612	BCP5ES	7496
77 00 742 094	BP7ES	2023
77 00 743 137	BCP5ES	7496
77 00 743 920	BP5ES	6511
77 00 749 163	BCP5ES	7496
77 00 824 821	BP6ES	7811
77 00 852 522	BP6EFS	3812
77 00 852 543	BP7EFVX	3344
77 00 852 543	TR7IX	3690
77 00 855 463	BCP6ET	4563
77 00 855 918	BP5EFS	3712
77 00 856 342	BCP6ET	4563
77 00 859 910	BCP5ES	7496
77 00 859 967	BP5ES	6511
77 00 861 471	BP7ES	2412
77 00 861 472	BP6ESZ	7639
77 00 862 054	BP5ES	6511
77 00 868 864	BPR7ES	2023
77 00 871 617	BCPR6ET	2197
77 01 021 767	BP6EFS	3812
77 01 041 214	BP5ES	6511
77 01 041 215	BP6EFS	3812
77 01 042 816	BKR6E	6962
77 01 043 624	BCPR6ET	2197
77 01 045 018	BP7EFS	3526
77 01 366 057	BP6HS	4511

RENAULT	NGK → STOCK No.	
77 01 366 084	BR8EIX	5044
77 01 366 085	BR7EIX	6664
77 01 366 086	BP6ES	7811
77 01 366 087	BP7ES	2412
77 01 366 137	BP6EFS	3812
77 01 366 267	BP6HS	4511
77 01 366 268	BP7ES	2412
77 01 366 269	BP6ES	7811
77 01 366 270	BP6EFS	3812
77 01 366 513	BP5HS	4111
77 01 366 514	BP6EFS	3812
77 01 366 515	BP6HS	4511
77 01 366 516	BP6ES	7811
77 01 366 533	B6HS	4510
77 01 366 539	BP5ES	6511
77 01 366 903	BP5ES	6511
77 01 414 022	BP5HS	4111
77 01 414 025	BP6ES	7811
77 01 414 026	BP7EFS	3526
77 01 414 027	BP7EFS	3526
77 01 414 031	BPR6ES	7822
82 00 030 765	LZKAR7A	6799
82 00 314 928	PPR7G-9	4371
82 00 322 273	LZKAR7A	6799
82 00 363 384	PPR6G-9	4377
82 00 492 426	PPR7Z-TG	5768
82 00 587 901	ILKAR7A7	91432
82 00 592 215	LZKAR7B	5942
82 00 662 185	LZKAR7A	6799
83 04 504 277	ZFR5F	5165
89 33 003 862	BKR6ES	3783
96 26 575 480	BKR6EK	2288
96 32 182 880	BKR6EK	2288
96 32 182 880	PPR6E-10	3688

SAAB	NGK → STOCK No.	
12620540	ILTR5D	5476
55564215	BKR7ESC-11	6313

SEAT - see VW GROUP

SKODA - see VW GROUP

SMART	NGK → STOCK No.	
000 3085 V005 0000 00	BKR6EKE	5649
A 003 159 92 03	BKR6EKE	5649

SPLITFIRE	NGK → STOCK No.	
TP006A	BP8EVX	2671
TP006A	BPR8EIX	6684
TP006B	BPR7EIX	4055
TP006C	BPR6EIX	6637
TP006D	BPR5EIX-11	6597
TP006E	BPR5EIX-11	6597
TP406B	BR9EIX	3981
TP406B	BR9EIX	3981
TP406C	BR8EIX	5044
TP406C	BR8EIX	5044
TP430B	CR9EIX	3521
TP430C	CR8EIX	4218

SUBARU	NGK → STOCK No.	
22401AA020	BP6ES	7811
22401AA090	BP7ES	2412
22401AA120	BPR6ES-11	4824
22401AA220	BPR6ES	7822
22401AA230	BPR7E	1142
22401AA310	BKR6E-11	2756
22401AA370	PPR6B-11	4014
22401AA400	PPR6B	3500
22401AA480	BPR5ES-11	4424
22401AA510	BKR6EIX	6418
22401AA670	SILFR6A6	8659
22401KA080	BKR6E	6962

UNIPART	NGK → STOCK No.
GSP2117	BPR5ES 7422
GSP2118	BPR6ES 7822
GSP2119	BPR6ES-11 4824
GSP2120	BPR6EFS 3623
GSP2121	BP5EFS 3712
GSP2122	PFR6N-11 3546
GSP2136	BKR6EQUP 3199
GSP2137	LF6B 6677
GSP2138	LF5B 7113
GSP2149	ZFR6S-Q 6449
GSP2151	IZKR7B 7563
GSP2212	PFR6N-11 3546
GSP244	BPR5ES 7422
GSP263	BPR6ES 7822
GSP264	BPR5ES 7422
GSP281	BPR7ES 2023
GSP30	B6S 3510
GSP331	BP5EFS 3712
GSP351	BP5EFS 3712
GSP361	BP6EFS 3812
GSP381	BP7EFS 3526
GSP4154	AP6FS 2710
GSP4266	B5HS 4210
GSP4352	BP6ES 7811
GSP4356	BP6HS 4511
GSP4362	BP6ES 7811
GSP4366	BP6HS 4511
GSP4372	BP5ES 6511
GSP4376	BP5HS 4111
GSP4382	BP5ES 6511
GSP4452	BPR7ES 2023
GSP4462	BPR6ES 7822
GSP4472	BPR5ES 7422
GSP4552	BCP7ES 5030
GSP4562	BCP6ES 4930
GSP4563	BP6EFS 3812
GSP4573	BP5EFS 3712
GSP461	BPR6EFS 3623
GSP4652	BCPR7ES 3330
GSP4662	BKR6E 6962
GSP4663	BPR6EFS 3623
GSP531	BP5HS 4111
GSP540	B5HS 4210
GSP541	BP6HS 4511
GSP550	B6HS 4510
GSP560	B7HS 5110
GSP571	BP7HS 5111
GSP634	BCPR5ES 6130
GSP6356	BP6HS 4511
GSP6382	BP5ES 6511
GSP6452	BPR7ES 2023
GSP6462	BPR6ES 7822
GSP6468	BPR6ES-11 4824
GSP6472	BPR5ES 7422
GSP664	BKR6E 6962
GSP665	BCP6ES 4930
GSP6651	PTR5A-10 5055
GSP6652	BCPR7ES 3330
GSP6658	BCPR7ES-11 1095
GSP6662	BKR6E 6962
GSP6663	BPR6EFS 3623
GSP6668	BCPR6ES-11 7121
GSP684	BCPR7ES 3330
GSP685	BCP7ES 5030
GSP761	BP6FS 3512
GSP881	BPR6FS 2623
GSP9652	PFR6N-11 3546
GSP981	AP6FS 2710

VAUXHALL/OPEL NGK → STOCK No.	
12 14 000	BKR5EK 7956
12 14 066	IFR7X7G 91039
12 620 540	ILTR5D 5476
55 564 748	DILFR7B10G 97218

VAUXHALL/OPEL NGK → STOCK No.	
55 564 763	ZFR6BP-G 1748
55 565 219	ZFR6V-G 8894
55 576 026	IFR7X7G 91039
90 239 568	BPR6ES 7822
90 239 569	BPR6HS 7022
90 336 461	BKR6ES 3783
90 338 179	BCPR6ET 2197
90 355 136	BPR6ES 7822
90 356 323	BPR5ES 7422
90 357 729	BKR6EK 2288
90 357 780	BKR6ES 3783
90 423 215	BKR6ES 3783
90 512 989	BKR5EK 7956
91 132 086	BKR5EQUB 1567
91 951 09	BKR5EK 7956
91 958 68	BKR5EQUB 1567
91 990 38	LTR6B-10T 5948
93 161 199	PFR6G-9 4377
93 176 801	ZFR5F 5165

VESPA NGK → STOCK No.	
137778	B6HS 4510
137917	B6ES 7310

VOLVO NGK → STOCK No.	
13 06 604	BPR6ES 7822
13 06 605	BPR6ES 7822
13 57 828	BPR7HS 6422
13 67 528	BPR6ES 7822
13 67 529	BPR6ES 7822
271 603	BKR6E 6962
271 727	BKR6E 6962
271 207	BKR6EKUB 3584
272 313	PFR6B 3500
30637308	PFR6B 3500
30637385	LF6D 4704
30650379	PLFR5A-11 7654
30731425	TR5B-13 4559
30751468	ILFR6B 6481
30777349	TR6AP-13 5809
35 17 980	BKR6E 6962
8658474	PLFR6A-11 7654
8694749	ITR6F13 4477
9146775	BKR6ETUC 3384
9202064	BKR6ETUC 3384

VW GROUP NGK → STOCK No.	
03F 905 600A	IZFR6P7 97153
06H 905 601A	PFR7S8EG 1675
101 000 000AB	BP6ESZ 7639
101 000 001AB	BP6ET 1263
101 000 001AC	BP6ET 1263
101 000 001AD	BP5ET-10 5156
101 000 001AE	BP5ET 2287
101 000 002AB	BP6ESZ 7639
101 000 003AA	BCP7ET 2078
101 000 004AA	BCP7ET 2078
101 000 005AA	BP6ET 1263
101 000 005AB	BP6ET 1263
101 000 005AD	BP5ET-10 5156
101 000 005AE	BP5ET 2287
101 000 005AF	BP5ET 2287
101 000 006AB	BP6ESZ 7639
101 000 006AC	BP6ESZ 7639
101 000 007AA	BP6ET 1263
101 000 007AB	BP6ET 1263
101 000 007AC	BP5ET-10 5156
101 000 007AD	BP6ET 1263
101 000 016AA	PFR7B 4853
101 000 016AB	PFR6Q 6458
101 000 017AA	BCP7ET 2078
101 000 026AB	BUR6ET 3172
101 000 027AA	BP6ET 1263
101 000 027AB	BP5ET 2287

VW GROUP NGK → STOCK No.	
101 000 027AC	BP5ET-10 5156
101 000 028AA	BCP7ET 2078
101 000 029AB	BUR6EFSZ 6837
101 000 033AA	BKR6ET-10 2397
101 000 033AB	BKR6ET 7873
101 000 033AC	BKR5ET 2789
101 000 033AF	BKR6ET 6437
101 000 033AG	BKR5ET-10 7553
101 000 034AA	BP6ESZ 7639
101 000 035AB	BKR5EKU 3964
101 000 035AH	BKR5EKUP 2890
101 000 035HJ	BKR6EKUB 3584
101 000 036AA	BUR6ET 3172
101 000 036AB	BUR5ET 3377
101 000 036AC	BUR5ET-10 7264
101 000 038AA	BPR5EKU 5685
101 000 038AB	BPR5EKU 5685
101 000 039AA	BPR5EKU 5685
101 000 039AB	BPR5EKU 5685
101 000 040AC	BUR5ET 3377
101 000 040AD	BUR6ET 3172
101 000 040AE	BUR5ET-10 7264
101 000 041AC	BKR6ET-10 2397
101 000 041AD	BKR6ET 6437
101 000 041AE	BKR6ET 7873
101 000 047AC	BKR6EIX 6418
101 000 049AD	BKR6ETA-10 7998
101 000 050AA	BUR5ET 3377
101 000 050AB	BUR5ET-10 7264
101 000 050AC	BUR6ET 3172
101 000 051AA	BKR6ET-10 2397
101 000 051AB	BKR6ET 7873
101 000 052AA	BUR6EFSZ 6837
101 000 060AA	BKR5ET-10 7553
101 000 062AB	PZFR5D-11 7968
101 000 063AA	PFR6Q 6458
101 000 063AC	PFR7Q 7963
101 000 065AA	BKR6ETA-10 7998
101 000 068AA	ZFR6S-Q 6449
101 905 600	PZFR5J-11 7743
101 905 600 A	PZFR6J-11 3586
101 905 600 B	PZFR6Q-11 5965
101 905 601	PZFR5D-11 7968
101 905 601B	PZFR5P-G 6893
101 905 601F	ZFR6T-11G 5960
101 905 606A	IZKR7B 7563
101 905 607	BKR6EKUE 9892
101 905 611	PFR6U-11G 5874
101 905 611A	PFR6X-11 5757
101 905 611G	PFR8S8EG 94460
101 905 616	BKR6EQUA 6872
101 905 617	ZFR5P-G 6893
101 905 617C	ZFR6T-11G 5960
101 905 618A	ZFR6T-11G 5960
101 905 620	PZFR5N-11T 7742
101 905 621	PFR7W-TG 5592
101 905 621B	PFR6W-TG 5547
101 905 622	ILZKR7A 1961
101 905 626	PZFR6R 5758
101 905 631C	PFR6Q 6458
101 905 631G	PFR8S8EG 94460
101 905 631H	PFR7S8EG 1675
400 905 619	PFR7G 4364

WOLF NGK → STOCK No.	
1015 306	AB6 2910
1018 301	BM6A 5921
1022 304	AB6 2910
2000 305	BMR6A 7421
2016 301	B7HS 5110
2050 324	BMR6A 7421
2085 300	BR6ES 4922
2090 306	BPR6ES 7822

YAMAHA NGK → STOCK No.	
14B-R465B-70	R0465B-10 7506
90793 20029	B95EGV 2145
90793 20030	B105EGV 2171
90793 20032	B10EG 3630
90890 78082	B10EGV 5927
94701 00039	B6HS 4510
94701 00040	B7HS 5110
94701 00041	B8HS 5510
94701 00042	B9HS 5810
94701 00043	B6ES 7310
94701 00044	B7ES 1111
94701 00045	B8ES 2411
94701 00046	B9ES 2611
94701 00050	BP7HS 5111
94701 00061	BR8EIX 5044
94701 00063	BR5EIX 3981
94701 00069	B5HS 4210
94701 00078	B5ES 6410
94701 00108	BP6HS 4511
94701 00110	BR7HS 4122
94701 00111	BR6ES 4922
94701 00112	BR7ES 5122
94701 00113	BR8EIX 5044
94701 00116	BP6ES 7811
94701 00117	BP7ES 2412
94701 00118	BP8ES 2912
94701 00148	B8HVX 2634
94701 00148	BR8HIX 7001
94701 00157	D8EA 2120
94701 00159	BP4HS 3611
94701 00160	B8HS-10 5126
94701 00168	BP5HS 4111
94701 00188	BR9ES 5722
94701 00189	D7EA 7912
94701 00193	BR9EIX 3981
94701 00194	BPR5HS 6222
94701 00195	BR8HS 4322
94701 00198	BPR6HS 7022
94701 00203	DR8ES-L 2923
94701 00204	BR8ES 5422
94701 00208	DR7ES 3123
94701 00217	B7HS-10 2129
94701 00218	BPR7ES 2023
94701 00219	BPR8ES 3923
94701 00227	BPR7HS 6422
94701 00232	BP6HS-10 6326
94701 00234	BPR6ES 7822
94701 00237	BP8HS-10 3823
94701 00241	DPR8EA-9 4929
94701 00248	BR6HS 3922
94701 00250	CR7HS 7223
94701 00251	BR9HS 4522
94701 00254	C7HSA 4629
94701 00256	C6HSA 3228
94701 00258	BPR4HS 7823
94701 00262	DPR7EA-9 5129
94701 00264	BP7HS-10 7829
94701 00266	D9EA 2420
94701 00268	BP8HS 2630
94701 00273	B6HS-10 1052
94701 00274	BR6HS-10 1090
94701 00280	BPR8HS 3725
94701 00282	CR6HS 7023
94701 00284	BPR6EIX 6637
94701 00285	BPR6EIX 6637
94701 00287	DR8ES 5423
94701 00292	BPR6HS-10 2633
94701 00300	CR5HS 2874
94701 00309	BR9HS-10 4551
94701 00311	BR5ES 4722
94701 00318	CR9E 6263
94701 00328	BPR5ES 7422
94701 00330	CR8E 1275
94701 00332	R5184-105 3334

YAMAHA		NGK → STOCK No.	
94701 00333	DR8EA	7162	
94701 00340	DR9EA	3437	
94701 00345	DR7EA	7839	
94701 00353	CR7E	4578	
94701 00361	DPR9EA-9	5329	
94701 00365	BR6FS	4323	
94701 00372	CR6HSA	2983	
94701 00375	DPR6EA-9	5531	
94701 00395	CR9EK	4548	
94701 00403	CR9EK	4548	
94701 00406	DPR5EA-9	2887	
94701 00408	CR9EIA-9	6289	
94702 00044	B7ES	1111	
94702 00045	B8ES	2411	
94702 00046	B9ES	2611	
94702 00149	B7HS	5110	
94702 00188	BR9ES	5722	
94702 00193	BR9EIX	3981	
94702 00195	BR8HS	4322	
94702 00204	BR8ES	5422	
94702 00211	BPMR6A	6726	
94702 00247	BR8HS-10	1134	
94702 00248	BR6HS	3922	
94702 00249	BR5HS	3722	
94702 00271	BR7HS-10	1098	
94702 00272	BR7HS	4122	
94702 00274	BR6HS-10	1090	
94702 00309	BR9HS-10	4551	
94702 00317	B9HS-10	3626	
94702 00323	B8EG	3430	
94702 00324	BR9EG	3230	
94702 00325	B9EG	3530	
94702 00326	BR8EG	3130	
94702 00331	BPR4ES	7222	
94702 00343	BR4ES	1097	
94702 00348	BPR2ES	2264	
94702 00349	BR7ES	5122	
94702 00357	BR9ECM	3252	
94702 00367	B10EG	3630	
94702 00372	CR6HSB	6500	
94702 00391	LF85A-11	6376	
94702 00400	LF86A-11	3672	
94702 00404	BKR7EKU	5881	
94702 00405	BKR6EKU	6993	
94702 00409	CR9EB	6955	
94702 00419	CR4HSB	4695	
94703 00277	B9EGV	5827	
94703 00420	CPR7EA-9	3901	

YANMAR		NGK → STOCK No.	
124190-78010	BPR4ES	7222	
160110-78011	B6HS	4510	
160232-78010	B4H	4110	
160560-78010	BPMR4A	6028	
160610-78010	BP4HS	3611	
160690-78010	BP6ES	7811	
160693-78010	BPR6ES	7822	
160769-78010	BR4HS	3322	
160793-78010	BPR5ES	7422	
160810-78010	BPR4HS	7823	
160998-78010	BPR6EY	6427	
181630-78010	BUHW	2622	

YHX - see CHINESE BRANDS



SPARK PLUG COVERS

STANDARD PLUG COVERS



EPDM RUBBER PLUG COVERS



The NGK range of resistor covers are designed to give perfect noise suppression across all frequencies whilst engine performance is not adversely affected whatsoever.

Featuring a resistor element pressed in between the plug terminal and the high tension wire connection, the construction is extremely durable, the resistor element is long enough to prevent interior flashover, and steady resistance is maintained. Superlative ceramic materials are incorporated that resist deterioration and have small resistance variation under over-load, whilst the plug connector is made of sturdy phenolic resin, practically oblivious to tremendous heat and high tension, and very rugged rubber material. The heat press insertion makes the construction all the more tough and vibration-resistant. Special rubber liners on both ends prevent moisture from causing electrical leakage.

All motorcycle manufacturers now comply with current legislation which demands a standard of noise suppression on every vehicle. This is achieved usually by fitting NGK resistor covers though in many cases a combination of NGK resistor covers and NGK resistor spark plugs (R type) is necessary to satisfy the ministry tests. It is emphasized that despite the use of both resistor covers and spark plugs in such engines, due to the unique and superior construction of NGK products there is no loss of performance or shortening of service life.

LBO5EMH and SDO5FM being of tough EPDM rubber construction are intended for competition/trial applications.

COVER SYMBOLS EXPLANATION CHART

External appearance		Resistance		Special Feature	
L	90° Elbow Type	None	Non-resistor	A	Special design
S	Straight	01	1 k Ω	H	Compact type
X	102° Elbow Std.	05	5 k Ω	P	Special waterproof cover
V	120° Elbow (Long)	10	10 k Ω	K	Silicon waterproof cover
Y	120° Elbow (Short)			M	Rubber sheathed
T	'T' Type			G	With rubber grommet
				W	Double connector springs
				F	For \varnothing 5mm HT cable
				L	Inductive resistor type
				Y	With handle
				Z	Special design

Suitable \varnothing Plug Thread		Suitable Terminal Type	
B	14 mm minimum	E	Terminal nut or solid post
C	10 mm minimum	F	Terminal stud
D	10 & 12 mm		
Z	10, 12 & 14 mm		

NGK RESISTOR PLUG COVERS

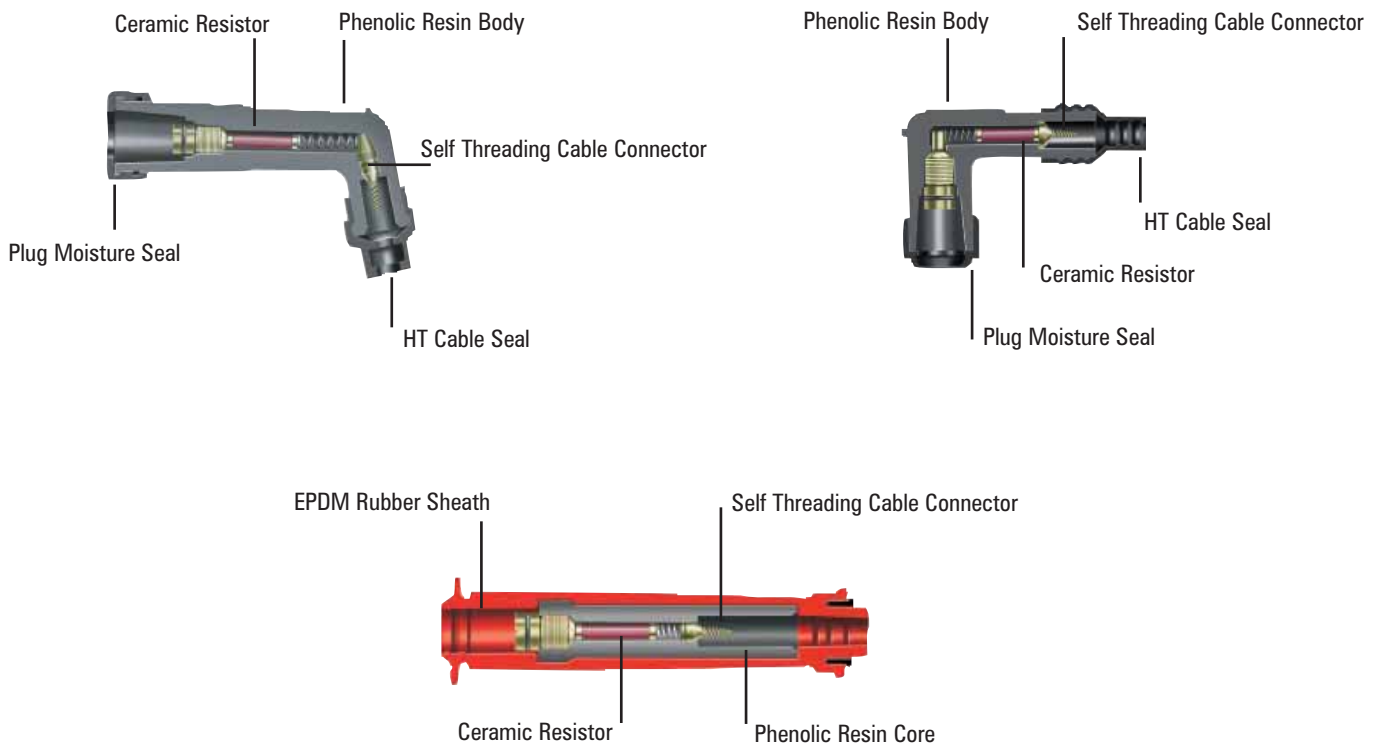

See pages 100 to 101 for full range of plug covers

SPARK PLUG COVERS

Part No.	Stock No.	Colour	Resistor	Ø Plug	Terminal Type
LB05E	8031	Black	5 kΩ	14mm	
LB05E-R	8898	Red	5 kΩ	14mm	
LB05F	8051	Black	5 kΩ	14mm	
LB05F-R	8854	Red	5 kΩ	14mm	

Description: 90° Elbow Type Material: Phenolic Resin

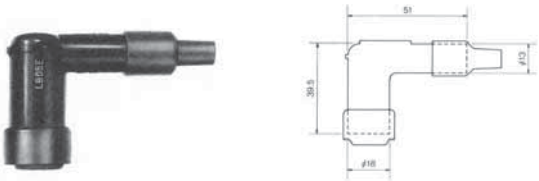

Part No.	Stock No.	Colour	Resistor	Ø Plug	Terminal Type
LZFH	8710	Black	None	10 - 14mm	

Description: 90° Non-resistor type Material: Phenolic Resin

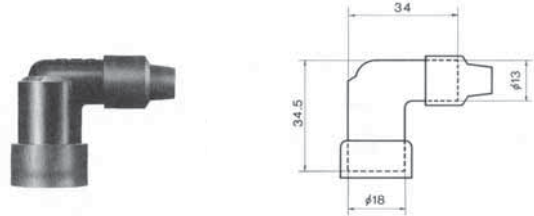

Part No.	Stock No.	Colour	Resistor	Ø Plug	Terminal Type
LB05EH	8334	Black	5 kΩ	14mm	
LB05EH-R	8688	Red	5 kΩ	14mm	
LB10EHF	8055	Black	10 kΩ	14mm	
LB10EHF-R	8058	Red	10 kΩ	14mm	

Description: 90° Elbow Type Material: Phenolic Resin

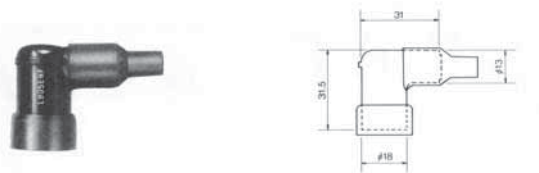

Part No.	Stock No.	Colour	Resistor	Ø Plug	Terminal Type
LB05EMH	8338	Black	5 kΩ	14mm	
LB05EMH-R	8160	Red	5 kΩ	14mm	

Description: 90° Rubber Sheathed Material: EPDM Rubber

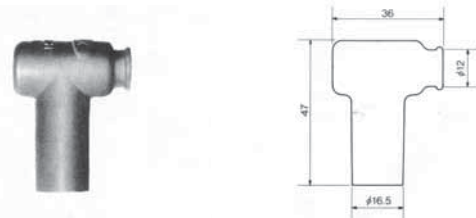

Part No.	Stock No.	Colour	Resistor	Ø Plug	Terminal Type
LD05F	8060	Black	5 kΩ	10 - 12mm	
LD05F-R	8231	Red	5 kΩ	10 - 12mm	

Description: 90° Elbow Type Material: Phenolic Resin

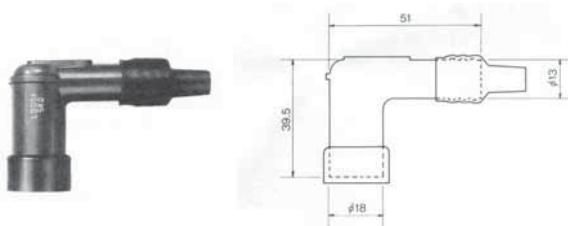

Part No.	Stock No.	Colour	Resistor	Ø Plug	Terminal Type
SB05E	8374	Black	5 kΩ	14mm	
SB05EC	8511	Red	5 kΩ	14mm	
SB05F	8080	Black	5 kΩ	14mm	
SB05F-R	8567	Red	5 kΩ	14mm	
SD05F	8022	Black	5 kΩ	10 - 12mm	
SD05F-R	8238	Red	5 kΩ	10 - 12mm	

Description: Straight Type Material: Phenolic Resin



Part No.	Stock No.	Colour	Resistor	Ø Plug	Terminal Type
SD05FM	8392	Black	5 kΩ	10 - 12mm	
SD05FM-R	8673	Red	5 kΩ	10 - 12mm	

Description: Straight Rubber Sheathed Material: EPDM Rubber

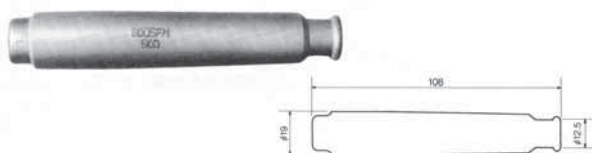

Part No.	Stock No.	Colour	Resistor	Ø Plug	Terminal Type
TB05EMA	8636	Black	5 kΩ	14mm	

Description: 90° Rubber Sheathed Material: Silicon Rubber

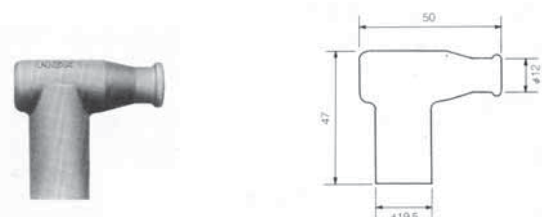

SPARK PLUG COVERS

Part No.	Stock No.	Colour	Resistor	Ø Plug	Terminal Type
XB05F	8062	Black	5 kΩ	14mm	
XB05F-R	8592	Red	5 kΩ	14mm	
XD05F	8072	Black	5 kΩ	10 - 12mm	
XD05F-R	8768	Red	5 kΩ	10 - 12mm	

Description: 102° Elbow Type Material: Phenolic Resin

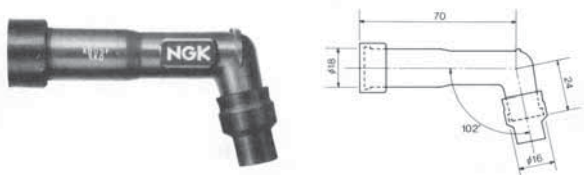

Part No.	Stock No.	Colour	Resistor	Ø Plug	Terminal Type
VB05F	8032	Black	5 kΩ	14mm	
VB05F-R	8759	Red	5 kΩ	14mm	
VD05F	8052	Black	5 kΩ	10 - 12mm	
VD05F-R	8376	Red	5 kΩ	10 - 12mm	

Description: 120° Elbow (Long) Type Material: Phenolic Resin



Part No.	Stock No.	Colour	Resistor	Ø Plug	Terminal Type
YB05F	8082	Black	5 kΩ	14mm	
YB05F-R	8162	Red	5 kΩ	14mm	

Description: 120° Elbow (Short) Type Material: Phenolic Resin

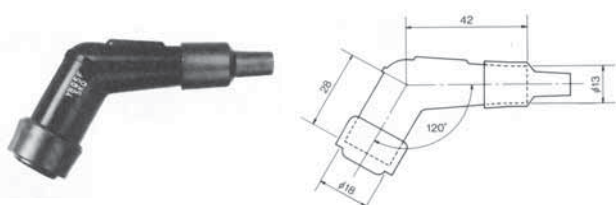

Part No.	Stock No.	Colour	Resistor	Ø Plug	Terminal Type
LBER-R	8307	Red	None	14mm	
LBER-B	8308	Blue	None	14mm	

Description: 90° Rubber Sheathed Material: Silicon Rubber

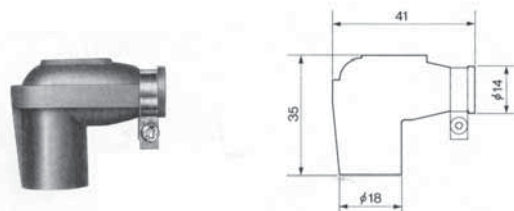

Part No.	Stock No.	Colour	Resistor	Ø Plug	Terminal Type
TRS1225-B	8787	Blue	5 kΩ	14mm	Special*

Description: 90° Compact Type Material: Silicon Rubber

**Suitable for use with R6120-□ racing spark plugs only*
**Suitable for use with R7282-□ racing spark plugs only*

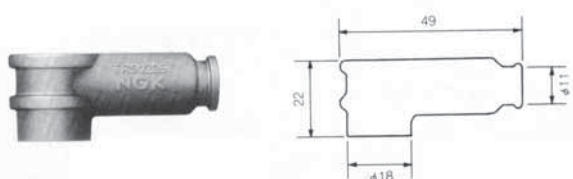

Part No.	Stock No.	Colour	Resistor	Ø Plug	Terminal Type
TRS1408F-B	8871	Blue	5 kΩ	14mm	Special*

Description: 90° Compact Type Material: Silicon Rubber

**Suitable for use with R5300A-□ racing spark plugs only*

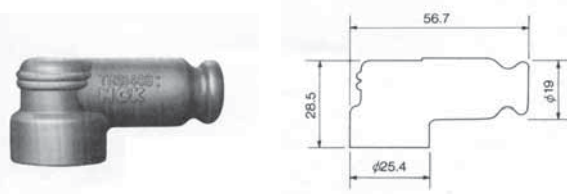

Part No.	Stock No.	Colour	Resistor	Ø Plug	Terminal Type
TRS1409-R	8733	Red	None	14mm	

Description: 90° Compact Type Material: Silicon Rubber

**Suitable for use with R5540F-□ racing spark plugs*

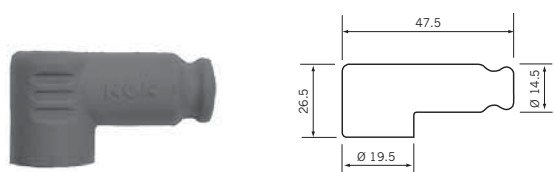

Part No.	Stock No.	Colour	Resistor	Ø Plug	Terminal Type
SD05EG	5818	Black	5 kΩ	10 - 12mm	

Description: Straight Type Material: Phenolic Resin

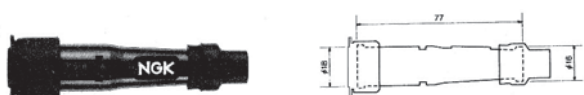

PLUG COVER SUPERSESSIONS

Current Part No.	Stock Number	replaced by	Replacement Part No.	Stock Number
LB05E (red)	8898	→	LB05E-R	8898
LB05EH (red)	8688	→	LB05EH-R	8688
LB05EMH (red)	8160	→	LB05EMH-R	8160
LB05F (red)	8854	→	LB05F-R	8854
LB10EHF (red)	8058	→	LB10EHF-R	8058
LBER (blue)	8308	→	LBER-B	8308
LBER (red)	8307	→	LBER-R	8307
LD05F (red)	8231	→	LD05F-R	8231
SB05F (red)	8567	→	SB05F-R	8567
SD05F (red)	8238	→	SD05F-R	8238
SD05FM (red)	8673	→	SD05FM-R	8673
TRS1225	8787	→	TRS1225-B	8787
TRS1408F	8871	→	TRS1408F-B	8871
TRS1409	8733	→	TRS1409-R	8733
VB05F (red)	8759	→	VB05F-R	8759
VD05F (red)	8376	→	VD05F-R	8376
XB05F (red)	8592	→	XB05F-R	8592
XD05F (red)	8768	→	XD05F-R	8768
YB05F (red)	8162	→	YB05F-R	8162

To assist in identifying the red or blue coloured variant for popular plug covers a small change to the descriptive part number has been instigated. Implementation will be managed on a running change basis i.e. when current stocks are exhausted orders will be fulfilled by supplying the replacement item. There is no change to the Stock Number. Black covers which are considered standard are unaffected.

NTK LAMBDA SENSORS FOR MOTORCYCLES

Reducing the pollution created by the internal combustion engine is a great concern for us all. To ensure that manufacturers build cleaner engines, the allowable limits for certain polluting gases are set by various government bodies. These limits are getting ever tighter and engine designers are under great pressure to find ways of meeting the targets. A vital part of the pollution control used on many engines is the exhaust gas oxygen sensor - more commonly known as the Lambda sensor. Commonplace on cars since the 1990's, Lambda sensors have been used on motorcycles since 1999 and are now fitted to an increasing number of machines over 125cc.

WHAT DOES THE LAMBDA SENSOR DO?

The most popular method used by vehicle manufacturers to reduce engine emissions is the three-way catalyst (catalytic converter). This device has the ability to take the three main toxic gases produced by an engine which are carbon monoxide (CO), oxides of nitrogen (NO_x) and hydrocarbons (HC) and convert them to considerably less harmful, non-poisonous gases: carbon dioxide (CO₂), water (H₂O) and nitrogen (N₂).

To carry out this conversion of gases efficiently the catalyst must operate within a specified temperature range but also be provided with exhaust gases that are within certain very tight tolerances dependant predominantly on air/fuel ratio. The precise control required to operate this system is provided by the use of an exhaust gas oxygen (Lambda) sensor installed upstream of the catalyst. A Lambda sensor has the ability to precisely measure the residual oxygen present in exhaust gases. By sending a signal to the control unit it can initiate a change to keep the fuelling system operating within the very tight tolerances required. This is known as a closed-loop control system.

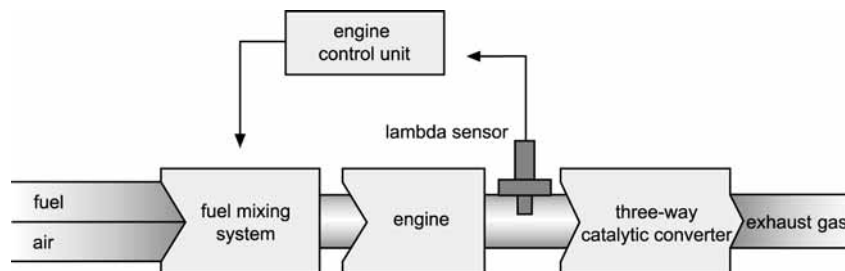

A worn or damaged sensor may affect the bike's general performance, increase fuel consumption, increase unwanted emissions and even damage the catalyst.

TECHNICAL INFORMATION

TORQUE FIGURES

Torque figures and thread form information:
M18 x 1.5mm - 35 ~ 45Nm **M12 x 1.5mm - 18 ~ 23Nm**

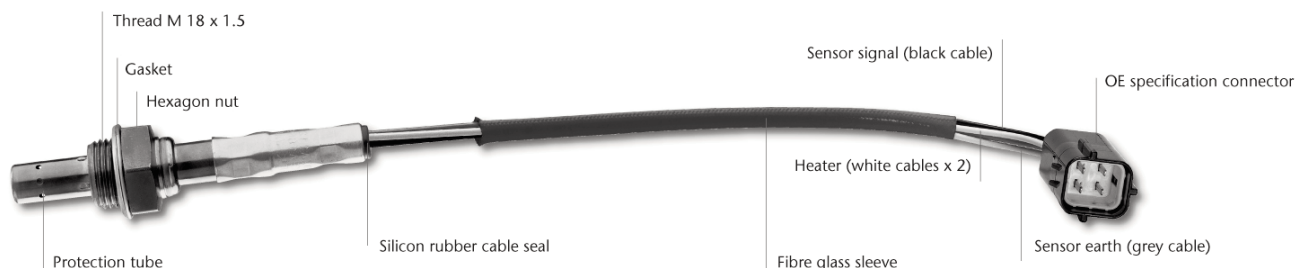

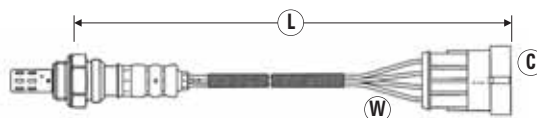

(W) = Number of Wires
 (C) = Connector Type (see page 108)
 (L) = Length of Sensor and Lead (mm)

CC/MODEL	ENGINE	OE-NO.	DATE	(W)	(C)	(L)	NTK PART NO.	STOCK NO.
APRILIA								
1000								
RSV 1000 R	Rotax V2	A2 C 53025886	04.04→	4	31	590	OZA591-SZ1	1767
RSV 1000 R Factory	Rotax V2	A2 C 53025886	10.03→	4	31	590	OZA591-SZ1	1767
ETV 1000 Caponord		AP8127295	04→07	4	33	890	OZA222-SG2	0034

BMW								
650								
F650CS		11787 685 320	11.01→12.03	4	68	341	OZA630-BM3	0074
F650CS	K14/02	11787 685 320	01.04→12.05	4	68	341	OZA630-BM3	0074
F650GS/GS Dakar		11787 685 320	09.99→12.03	4	68	341	OZA630-BM3	0074
F650GS/GS Dakar	R13Mü	11787 685 320	12.03→11.07	4	68	341	OZA630-BM3	0074
G650 Xchallenge, Xcountry, Xmoto	K15	11787 674 452	07→	4	99	231	OZA630-BM1	0072
800								
F650GS/GS Dakar		11787 672 785	11/07→	4	99	521	OZA630-BM2	0073
F800GS	K72	11787 672 785	11/07→	4	99	521	OZA630-BM2	0073
F800R	K73	11787 672 785	05/09→	4	99	521	OZA630-BM2	0073
F800S/ST	K71	11787 672 785	12.05→	4	99	521	OZA630-BM2	0073
850								
R850R	R28	11787 671 756	07.02→08.05	4	69	922	OZA522-BM1	0053
R850RT	R22	11787 671 756	03.01→12.04	4	69	922	OZA522-BM1	0053
1085								
R1100S	259S	11787 671 756	01.03→12.03	4	69	922	OZA522-BM1	0053
1150								
R1150GS	R21	11787 671 756	11.01→12.03	4	69	922	OZA522-BM1	0053
R1150GS Adventure	R21	11787 671 756	11.01→09.06	4	69	922	OZA522-BM1	0053
R1150R	R28	11787 671 756	10.02→08.05	4	69	922	OZA522-BM1	0053
R1150RS/RT	R22	11787 671 756	03.01→12.04	4	69	922	OZA522-BM1	0053
1170								
HP2 Enduro	K25 HP	11787 674 452	12.05→	4	99	231	OZA630-BM1	0072
HP2 Megamoto	K25 HP	11787 674 452	07→	4	99	231	OZA630-BM1	0072
HP2 Sport	K29 HP	11787 672 785	08→	4	99	521	OZA630-BM2	0073
1200								
K1200GT	K41GT	11787 671 756	11.02→08.05	4	69	922	OZA522-BM1	0053
K1200GT	K44	11787 672 785	12.05→	4	99	521	OZA630-BM2	0073
K1200R	K43	11787 672 785	03.05→	4	99	521	OZA630-BM2	0073
K1200R Sport	K43	11787 672 785	11/07→	4	99	521	OZA630-BM2	0073
K1200S	K40	11787 672 785	06.04→	4	99	521	OZA630-BM2	0073
K1200LT	K589	11787 671 757	01.04→	4	69	554	OZA522-BM2	0054
K1200RS	K41	11787 671 756	01.01→12.04	4	69	922	OZA522-BM1	0053
R1200C/CL	259C/K30	11787 671 756	02.02→12.04	4	69	922	OZA522-BM1	0053
R1200GS	K25	11787 674 452	11.03→09	4	99	231	OZA630-BM1	0072
R1200RT	K26	11787 674 452	10.04→	4	99	231	OZA630-BM1	0072
R1200S	K29	11787 674 452	10.05→	4	99	231	OZA630-BM1	0072
R1200ST	K28	11787 674 452	12.04→	4	99	231	OZA630-BM1	0072
1300								
K1300GT	K44	11787 672 785	09→	4	99	521	OZA630-BM2	0073
K1300R	K43	11787 672 785	09→	4	99	521	OZA630-BM2	0073
K1300S	K40	11787 672 785	09→	4	99	521	OZA630-BM2	0073

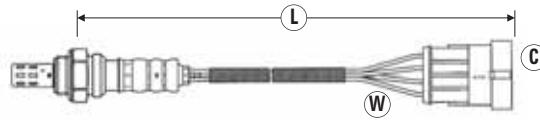

W = Number of Wires
C = Connector Type (see page 108)
L = Length of Sensor and Lead (mm)

CC/MODEL	ENGINE	OE-NO.	DATE	W	C	L	NTK PART NO.	STOCK NO.
DUCATI								
695								
Monster 695		CA.0083 476	06.04→	4	40	880	OZA591-BB3	0066
992								
GT 1000		CA.0083 476	01.06→	4	40	880	OZA591-BB3	0066
Monster S2R 1000		CA.0083 476	01.06→	4	40	880	OZA591-BB3	0066
Paul Smart 1000		CA.0083 476	01.06→	4	40	880	OZA591-BB3	0066
ST3, ST3S		CA.0083 476	01.04→	4	40	880	OZA591-BB3	0066
Sport 1000		CA.0083 476	01.06→	4	40	880	OZA591-BB3	0066
998								
Monster S4RS		CA.0083 476	06.04→	4	40	880	OZA591-BB3	0066

HONDA								
125								
FES125 Pantheon		36531-KRJ-9010-M1	01.05→	4	96	280	OZA577-H6	0065
PS125i		36531-KTF-6410-M1	01.06→	4	96	210	OZA577-H15	0064
SH125i		36531-KTF-6410-M1	01.05→	4	96	210	OZA577-H15	0064
150								
FES150i Pantheon		36531-KRJ-9010-M1	01.05→	4	96	280	OZA577-H6	0065
1000								
CBF1000		36531-MFAA-D001-M1	01.06→	4	80	990	OZA577-H17	0007

HUSQVARNA								
450								
TE450		E 252 201	09.07→	4	97	410	OZA591-WB1	0010
SM450R		E 252 201	09.07→	4	97	410	OZA591-WB1	0010
510								
SM510R		E 252 201	09.07→	4	97	410	OZA591-WB1	0010
610								
SM610		E 252 201	10.06→	4	97	410	OZA591-WB1	0010

HYOSUNG								
647								
GT650i			01.08→	4	97	410	OZA591-WB1	0010
GT650i			01.08→	4	97	410	OZA591-WB1	0010
GV650i			01.08→	4	97	410	OZA591-WB1	0010
GV650i			01.08→	4	97	410	OZA591-WB1	0010

KTM								
999								
990 Adventure / S		1614 833 0000	01.06→	4	97	500	OZA591-VB2	0009
990 Superduke		1614 833 0000	01.06→	4	97	500	OZA591-VB2	0009

KYMCO								
200								
Yager 200i		3160-0361	06.06→	4	31	590	OZA591-YB1	0011
250								
Venox 250 Afi		3160-0361	06.06→	4	31	590	OZA591-YB1	0011
Xciting 250i		3160-0361	06.06→	4	31	590	OZA591-YB1	0011

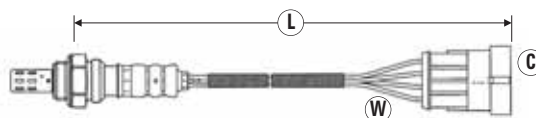

(W) = Number of Wires
 (C) = Connector Type (see page 108)
 (L) = Length of Sensor and Lead (mm)

CC/MODEL	ENGINE	OE-NO.	DATE	(W)	(C)	(L)	NTK PART NO.	STOCK NO.
MOTO GUZZI								
750								
Breva V750 i.e.		CA.0083477.A	01.03→	4	40	310	OZA591-BB2	1710
Nevada V750 i.e.		CA.0083477.A	01.06→	4	40	310	OZA591-BB2	1710
877								
Breva V850 i.e.		CA.0083477.A	01.06→	4	40	310	OZA591-BB2	1710
Griso V850 i.e.		CA.0083477.A	01.06→	4	40	310	OZA591-BB2	1710
Norge V850 i.e.		CA.0083477.A	01.06→	4	40	310	OZA591-BB2	1710
1100								
Breva V 1100		CA.0019 265	03.04→12.05	4	40	310	OZA341-BB1	0036
Breva V 1100 i.e.		CA.0083477.A	01.06→	4	40	310	OZA591-BB2	1710
California		CA.0019 265	03.04→12.05	4	40	310	OZA341-BB1	0036
California		CA.0083477.A	01.06→	4	40	310	OZA591-BB2	1710
Griso V 1100 i.e.		CA.0083477.A	01.06→	4	40	310	OZA591-BB2	1710
V11 Models		CA.0019 265	03.04→12.05	4	40	310	OZA341-BB1	0036
1150								
Norge 1200		CA.0083477.A	01.06→	4	40	310	OZA591-BB2	1710
Sport V 1200		CA.0083477.A	01.06→	4	40	310	OZA591-BB2	1710
Stelvio 1200 4V		CA.0083477.A	01.09→	4	40	310	OZA591-BB2	1710

MOTO MORINI								
1187								
9½		CA.0083477.A	01.06→	4	40	310	OZA591-BB2	1710
Corsaro		CA.0083477.A	01.06→	4	40	310	OZA591-BB2	1710

MV AGUSTA								
910								
F4 Brutale 910		CA.0083477.A	10.06→12.08	4	40	310	OZA591-BB2	1710
989								
Brutale 989		CA.0083477.A	01.09→	4	40	310	OZA591-BB2	1710
998								
F4 1000R		CA.0083477.A	10.06→12.08	4	40	310	OZA591-BB2	1710
1078								
Brutale 1078 RR		CA.0083477.A	01.09→	4	40	310	OZA591-BB2	1710
F4 1000		CA.0083477.A	07.07→12.08	4	40	310	OZA591-BB2	1710
F4 1078R		CA.0083477.A	01.09→	4	40	310	OZA591-BB2	1710



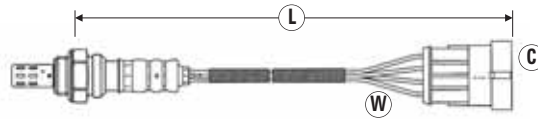

SUZUKI								
600								
GSX-R600		18213-01H00	03.06→	4	80	690	OZA448-J4	0003
750								
GSX-R750		18213-01H00	03.06→	4	80	690	OZA448-J4	0003
1800								
VZR1800 K6 M1800R Intruder		18213-48G00	04.06→	4	80	370	OZA448-J5	0004

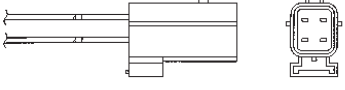
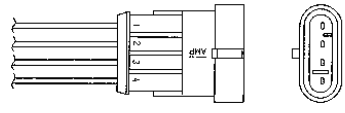

(W) = Number of Wires
 (C) = Connector Type (see page 108)
 (L) = Length of Sensor and Lead (mm)

CC/MODEL	ENGINE	OE-NO.	DATE	(W)	(C)	(L)	NTK PART NO.	STOCK NO.
TRIUMPH								
600								
Daytona 600		22 01 347	01.03→12.05	4	97	640	OZA591-UB1	0067
Speed Four		22 01 347	01.02→	4	97	640	OZA591-UB1	0067
885								
Thunderbird Sport		22 01 347	01.03→12.04	4	97	640	OZA591-UB1	0067
955								
Daytona 955i		22 01 347	01.01→	4	97	640	OZA591-UB1	0067
Speed Triple		22 01 347	01.01→12.05	4	97	640	OZA591-UB1	0067
Sprint RS		22 01 347	01.01→12.04	4	97	640	OZA591-UB1	0067
Sprint ST		22 01 347	01.01→12.04	4	97	640	OZA591-UB1	0067
Tiger		22 01 347	01.03→	4	97	640	OZA591-UB1	0067
1050								
Sprint ST		22 01 347	01.05→	4	97	640	OZA591-UB1	0067
Speed Triple		22 01 347	01.06→12.07	4	97	640	OZA591-UB1	0067
1600								
Thunderbird			07.09→	4	80	250	AZD0101-VB004	7690
2300								
Rocket III		22 01 247	01.04→	4	97	535	OZA591-UB2	0008
Rocket III Classic		22 01 247	01.06→	4	97	535	OZA591-UB2	0008

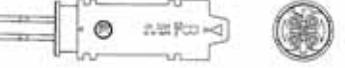
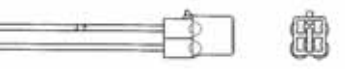
CONNECTOR TYPES

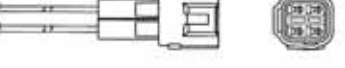
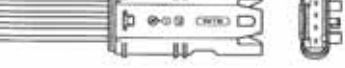
	Application	Order
31 	OZA591-YB1	0011
	OZA591-SZ1	1767
33 	OZA222-SG2	0034
40 	OZA341-BB1	0036
68 	OZA447-E28	0427
	OZA630-BM3	0074
69 	OZA522-BM1	0053
	OZA522-BM2	0054
80 	OZA448-J4	0003
	OZA448-J5	0004
	OZA577-H17	0007
	AZD0101-VB004	7690
96 	OZA577-H15	0064
	OZA577-H6	0065
97 	OZA591-UB1	0067
	OZA591-UB2	0008
	OZA591-VB2	0009
99 	OZA630-BM2	0073

